

# **CATALOGO DE PERFILES SISTEMA B 2005**



























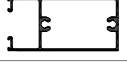

- 4 ..... Índice de Perfiles Frente Integral
  - Detalle de Perfiles en Escala 1:1
- 6 ..... Paño Fijo / Puerta de Rebatir
- 7 ..... Ventana de Rebatir / Banderola / Ventiluz / Desplazable /  
Contravidrios / Pletinas
- 8 ..... Premarcos / Contramarcos / Apliques Perimetrales /  
Vidrio Repartido
- 9 ..... Acoples / Columnas

**Peso de las Barras de Perfiles:** El peso por metro de los perfiles es estimado, con una tolerancia de + / - 10%.

**Largo de las Barras de Perfiles:** La medida Standard de las Barras de Perfiles es de 6.030 milímetros, salvo aclaración en contrario.

**Alsafex S.A.** se reserva el derecho de realizar cambios y/o modificaciones sin previo aviso de los contenidos y artículos indicados en el presente catálogo.

CODIGO	PESO (Kg/m.)	LARGO (mm.)	DESCRIPCION	FORMA	PAG.
1010091	0,35	6.030	Travesaño Vidrio Repartido		8
1010441	0,18	6.150	Contramarco Recto Universal		8
1010453	0,45	6.030	Acople Recto		9
1010455	1,18	6.030	Columna Acople a 90° / 180°		9
1010648	0,50	6.150	Premarco de 55 mm.		8
1010709	0,19	6.150	Contramarco Curvo de 30 mm.		8
1010986	1,06	6.030	Columna Curva		9
1011948	0,35	6.030	Aplique Perimetral 12 mm.		8
1011964	0,35	6.030	Aplique Perimetral 7 mm.		8
1020633	0,26	6.030	Contravidrio Recto 22 mm.		7
1020644	0,18	6.030	Contravidrio Recto 5 mm.		7
1020645	0,21	6.030	Contravidrio Recto 15 mm.		7
1020666	0,16	6.030	Contravidrio Curvo 15 mm.		7
1020680	0,18	6.030	Contravidrio Curvo 22 mm.		7
1020690	0,14	6.030	Contravidrio Curvo 8 mm.		7
1020703	0,16	6.150	Pletina de Aluminio		7
1032977	0,72	6.200	Marco Puerta, Ventana de Rebatir, Banderola, Ventiluz, Desplazable, Paño Fijo		6
1032978	0,69	6.030	Hoja V.S. Ventana de Rebatir, Banderola, Ventiluz, Desplazable		7
1032979	0,65	6.030	Hoja D.V.H. Ventana de Rebatir, Banderola, Ventiluz, Desplazable		7
1032980	0,54	6.030	Encuentro Central Ventana y Puerta de Rebatir		6
1032981	0,79	6.200	Parante Puerta de Rebatir		6
1032982	1,01	6.030	Zócalo Puerta de Rebatir		6
1032983	0,61	6.030	Travesaño Puerta de Rebatir		6

CODIGO	PESO (Kg/m.)	LARGO (mm.)	DESCRIPCION	FORMA	PAG.
1032984	0,35	6.030	Adaptador V.S. Puerta de Rebatir		6
1032985	0,30	6.030	Adaptador D.V.H. Puerta de Rebatir		6
1050840	0,63	6.150	Premarco de 70 mm.		8
9469	-	6.150	Pletina de Poliamida		7

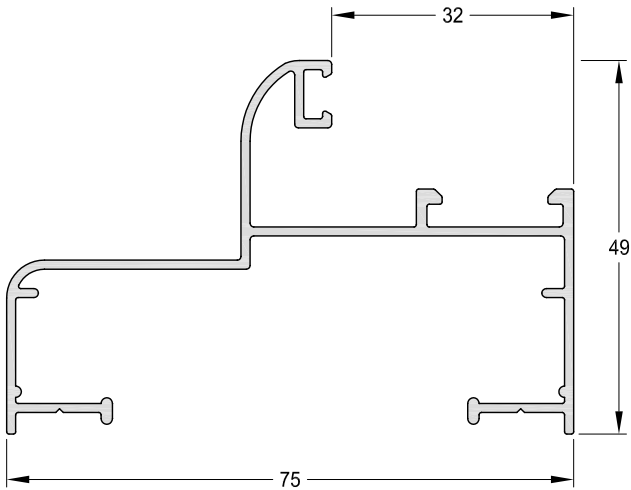

1032977 - Marco  
Peso: 0,72 Kg/m.  
Largo Std.: 6.200 mm.

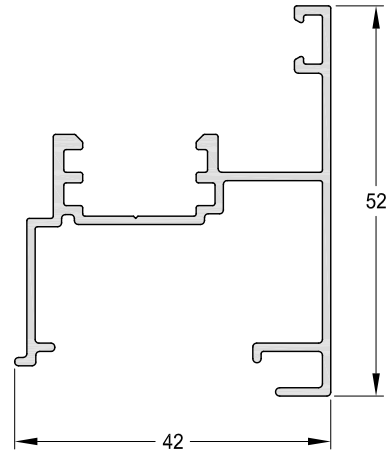

1032980 - Encuentro Central  
Ventana y Puerta de Rebatir  
Peso: 0,54 Kg/m.  
Largo Std.: 6.030 mm.

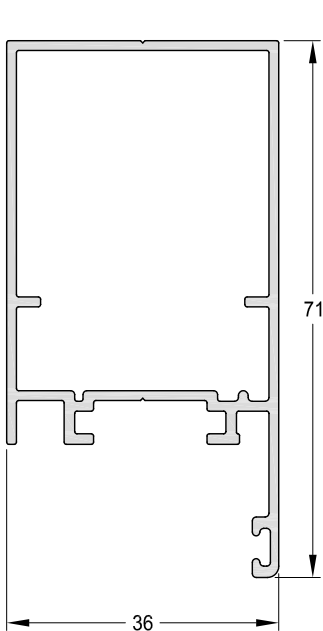

1032981 - Parante  
Peso: 0,79 Kg/m.  
Largo Std.: 6.200 mm.

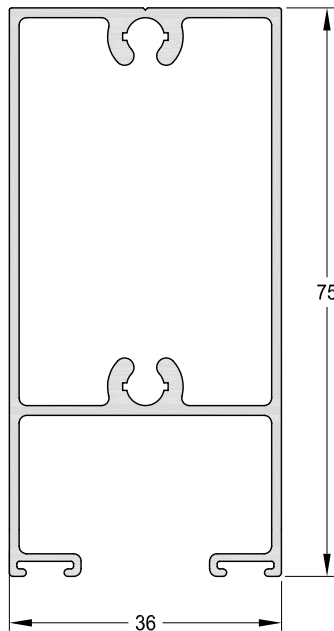

1032982 - Zócalo  
Peso: 1,01 Kg/m.  
Largo Std.: 6.030 mm.

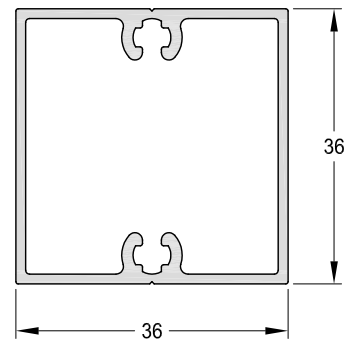

1032983 - Travesaño  
Peso: 0,61 Kg/m.  
Largo Std.: 6.030 mm.

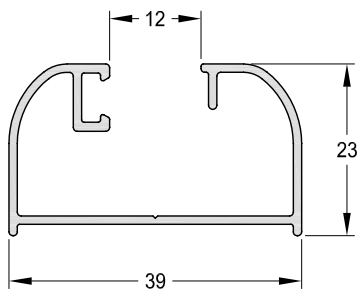

1032984 - Adaptador V.S.  
Peso: 0,35 Kg/m.  
Largo Std.: 6.030 mm.

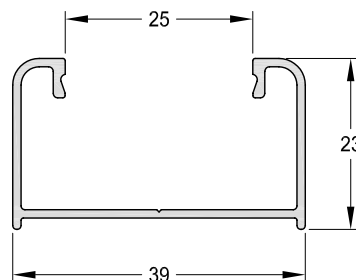

1032985 - Adaptador D.V.H.  
Peso: 0,30 Kg/m.  
Largo Std.: 6.030 mm.

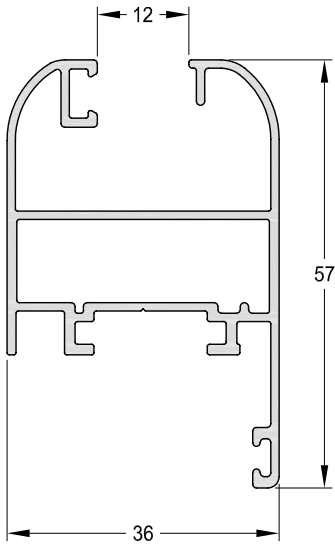

1032978 - Hoja V.S.  
Peso: 0,69 Kg/m.  
Largo Std.: 6.030 mm.

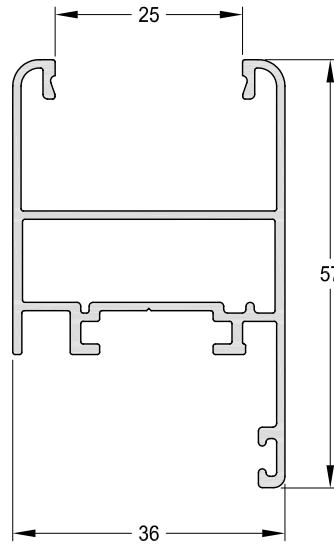

1032979 - Hoja D.V.H.  
Peso: 0,65 Kg/m.  
Largo Std.: 6.030 mm.

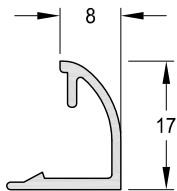

1020690 - Contravidrio  
Curvo 8 mm.  
Peso: 0,14 Kg/m.  
Largo Std.: 6.030 mm.

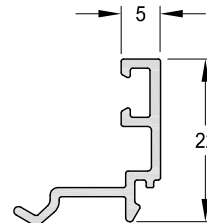

1020644 - Contravidrio  
Recto 5 mm.  
Peso: 0,18 Kg/m.  
Largo Std.: 6.030 mm.

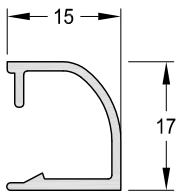

1020666 - Contravidrio  
Curvo 15 mm.  
Peso: 0,16 Kg/m.  
Largo Std.: 6.030 mm.

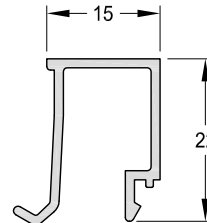

1020645 - Contravidrio  
Recto 15 mm.  
Peso: 0,21 Kg/m.  
Largo Std.: 6.030 mm.

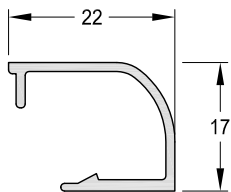

1020680 - Contravidrio  
Curvo 22 mm.  
Peso: 0,18 Kg/m.  
Largo Std.: 6.030 mm.

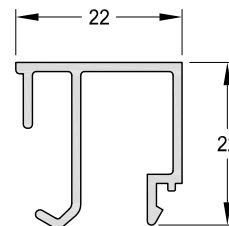

1020633 - Contravidrio  
Recto 22 mm.  
Peso: 0,26 Kg/m.  
Largo Std.: 6.030 mm.

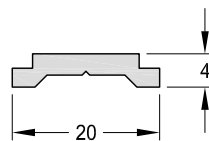

1020703 - Pletina de Aluminio  
Peso: 0,16 Kg/m.  
Largo Std.: 6.150 mm.

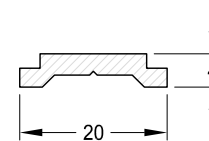

9469 - Pletina de Poliamida  
Largo Std.: 6.150 mm.

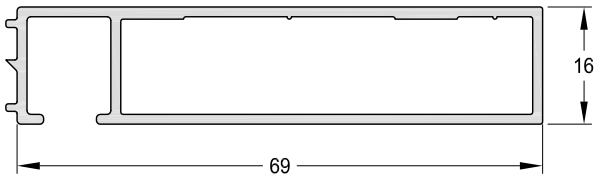

1050840 - Premarco  
 Peso: 0,63 Kg/m.  
 Largo Std.: 6.150 mm.

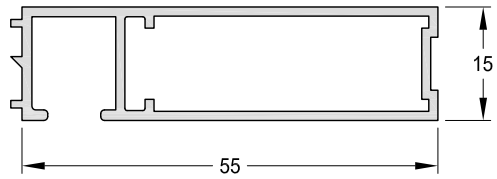

1010648 - Premarco de 55 mm.  
 Peso: 0,50 Kg/m.  
 Largo Std.: 6.150 mm.

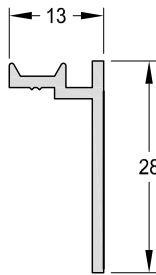

1010441 - Contramarco  
 Peso: 0,18 Kg/m.  
 Largo Std.: 6.150 mm.

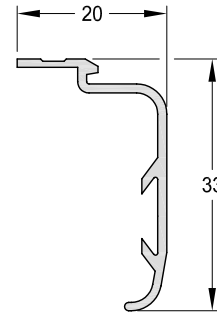

1010709 - Contramarco  
 Peso: 0,19 Kg/m.  
 Largo Std.: 6.150 mm.

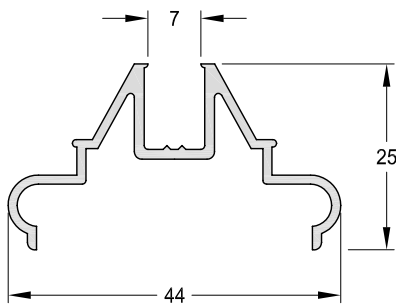

1011964 - Aplique Perimetral 7 mm.  
 Peso: 0,35 Kg/m  
 Largo Std.: 6.030 mm.

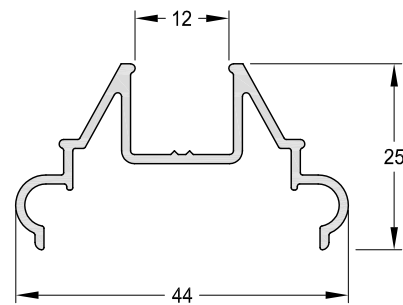

1011948 - Aplique Perimetral 12 mm.  
 Peso: 0,35 Kg/m.  
 Largo Std.: 6.030 mm.

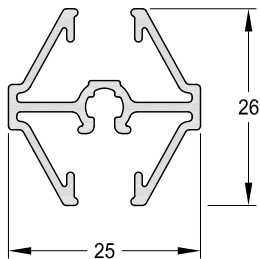

1010091 - Travesaño  
 Vidrio Repartido  
 Peso: 0,35 Kg/m.  
 Largo Std.: 6.030 mm.



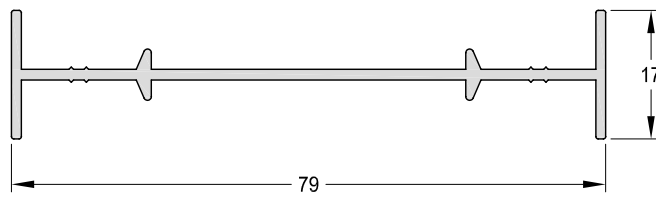

1010453 - Acople Recto  
Peso: 0,45 Kg/m.  
Largo Std.: 6.030 mm.

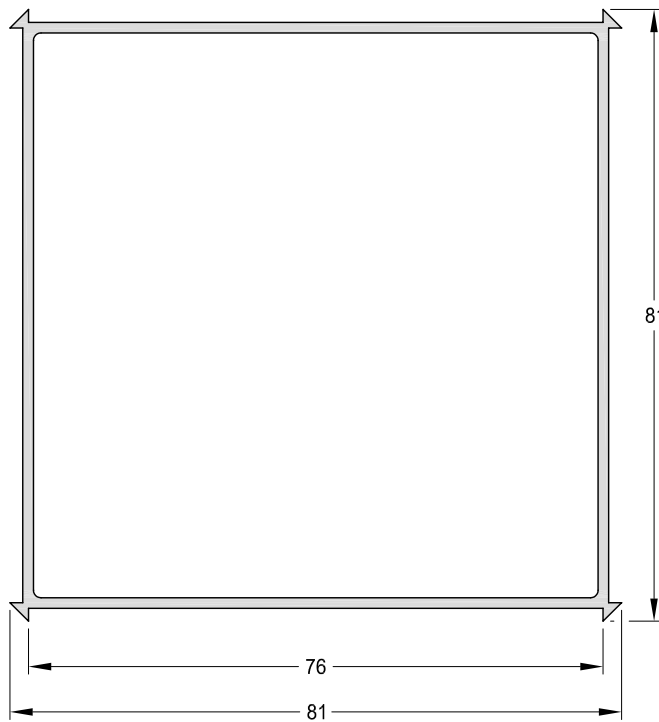

1010455 - Columna  
Acople a 90° / 180°  
Peso: 1,18 Kg/m.  
Largo Std.: 6.030 mm.

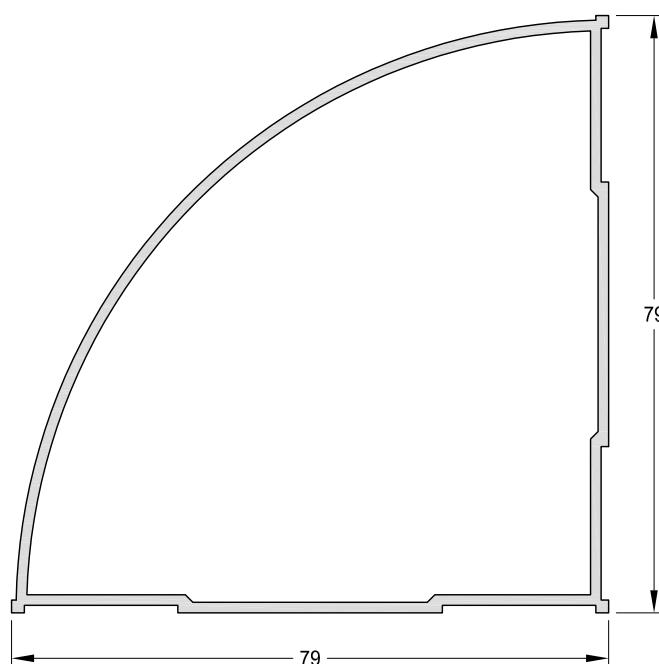

1010986 - Columna Curva  
Peso: 1,06 Kg/m.  
Largo Std.: 6.030 mm.

