















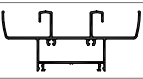



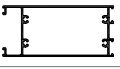

CATALOGO DE PERFILES SISTEMA ALFA

- 4 Índice de Perfiles
 - Detalle de Perfiles en Escala 1:1
- 6 Ventana y Puerta Corrediza]
- 9 Paño Fijo
- 10 Puerta de Rebatir
- 11 Contravidrios

Peso de las Barras de Perfiles: El peso por metro de los perfiles es estimado, con una tolerancia de + / - 10%.

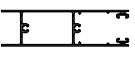
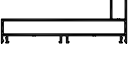
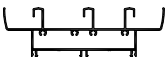

Largo de las Barras de Perfiles: La medida Standard de las Barras de Perfiles es de 6.030 milímetros, salvo aclaración en contrario.

Alsafex S.A. se reserva el derecho de realizar cambios y/o modificaciones sin previo aviso de los contenidos y artículos indicados en el presente catálogo.

CODIGO	PESO (Kg/m.)	LARGO (mm.)	DESCRIPCION	FORMA	PAG.
3083	0,35	6.200	Contramarco p/ Atornillar		6
4000	0,26	6.200	Adaptador VS en Zócalo y Dintel Ventana y Puerta Corrediza		8
4001	0,32	6.200	Adaptador VS en Parantes Ventana y Puerta Corrediza		8
4036	0.89	6.200 (5)	Jamba de Marco Ventana y Puerta Corrediza		6
4037	1,74	6.200 (5)	Zócalo y Dintel de Marco Ventana y Puerta Corrediza		6
4040	1,18	6.200	Marco Puerta de Rebatir		10
4041	1,39	6.200	Hoja Puerta de Rebatir		10
4042	1,40	6.200	Travesaño Puerta de Rebatir		10
4043	2,32	6.200	Zócalo Puerta de Rebatir		10
4044	1,04	6.200	Encuentro Central Puerta de Rebatir		10
4045	0,35	6.200	Contravidrios Recto p/DVH. Paño Fijo		9
4046	0,27	6.200	Contravidrios Recto Paño Fijo		9
4047	0,25	6.200	Contravidrios Curvo Paño Fijo		9
4048	0,20	6.200	Contravidrios Curvo p/DVH. Paño Fijo		9
4049	0,23	6.200	Contravidrios Recto Exterior Puerta de Rebatir		9
4050	0,19	6.200	Contravidrios Curvo Exterior Puerta de Rebatir		9
4059	1,00	6.200	Marco Paño Fijo Recto		9
4071	1,29	6.200 (5)	Parante Lateral p/DVH. Ventana y Puerta Corrediza		7
4072	1,47	6.200 (5)	Parante Central p/DVH. Ventana y Puerta Corrediza		7
4073	0,86	6.200	Zócalo y Cabezal p/DVH. Ventana y Puerta Corrediza		8
4074	1,41	6.200	Zócalo Alto p/DVH. Ventana y Puerta Corrediza		8
4080	1,57	6.200 (5)	Jamba de Marco 3 guías Ventana y Puerta Corrediza		7
4081	2,78	6.200 (1)	Umbral Dintel de Marco 3 guías Ventana y Puerta Corrediza		6

Referencia (1): Largo Opcional de Barra 4.500 milímetros

Referencia (5): Largo Opcional de Barra 4.800 milímetros

CODIGO	PESO (Kg/m.)	LARGO (mm.)	DESCRIPCION	FORMA	PAG.
4082	1,27	6.200	Parante Central 3er hoja DVH. Ventana y Puerta Corrediza		7
4965	0,29	6.200	Encuentro Central Corrediza 4 Hojas		7

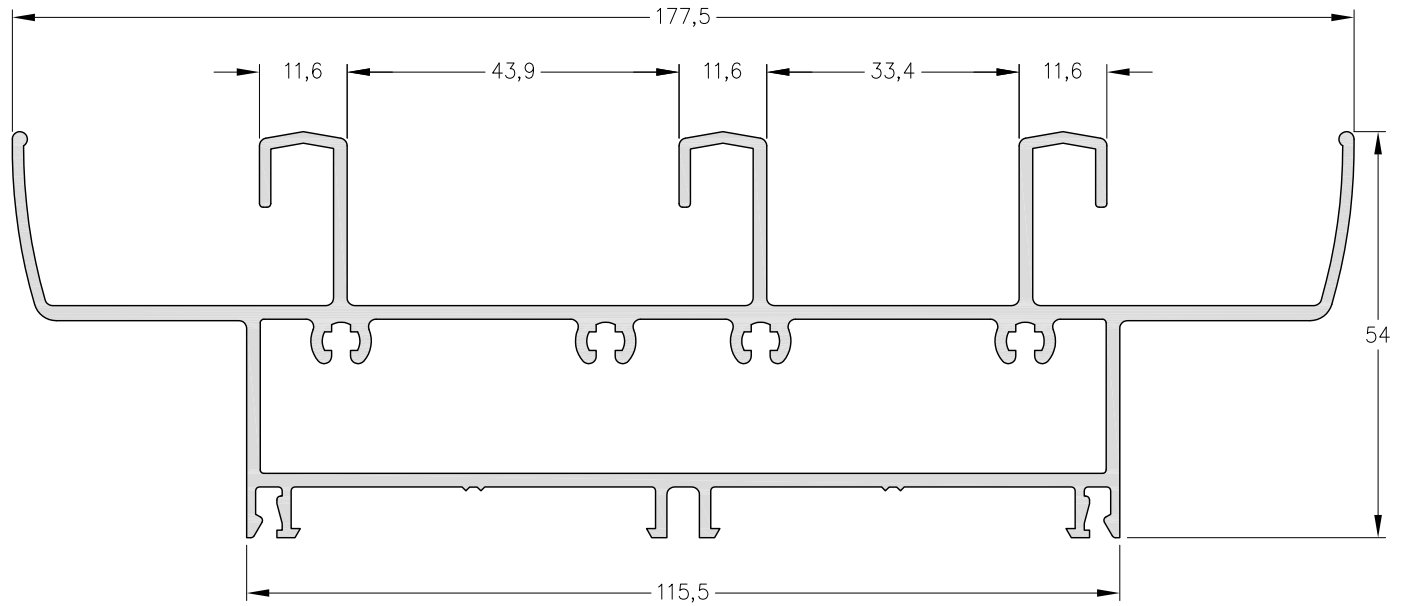

4081 - Umbral dintel de marco 3 guías.

Peso: 2.780 Kg/m.

Largo Std.: 6.200 mm.

Largo Opc. 4.500 mm.

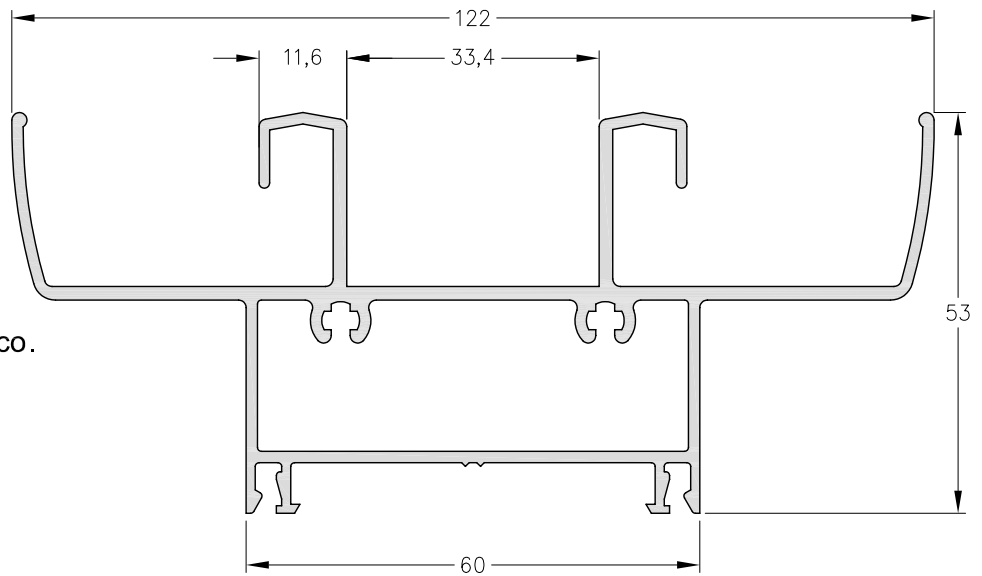

4037 - Zócalo y Dintel de marco.

Peso: 1.742 Kg/m.

Largo Std.: 6.200 mm.

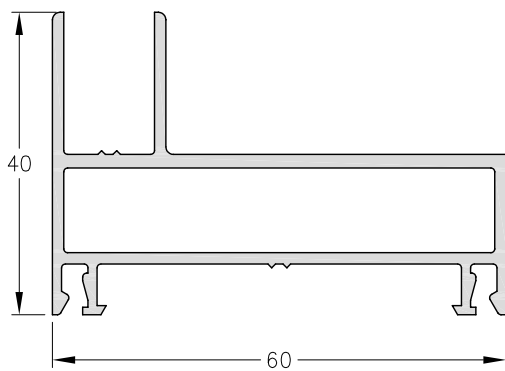

4036 - Jamba de marco.

Peso: 0.894 Kg/m.

Largo Std.: 6.200 mm.

Largo Opc.: 4800 mm.

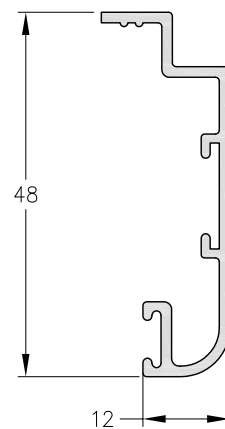

3083 - Contramarco p/ Atornillar.

Peso: 0,346 Kg/m.

Largo Std.: 6.200 mm.

Escala 1:1

Tolerancia en Peso +/- 10%

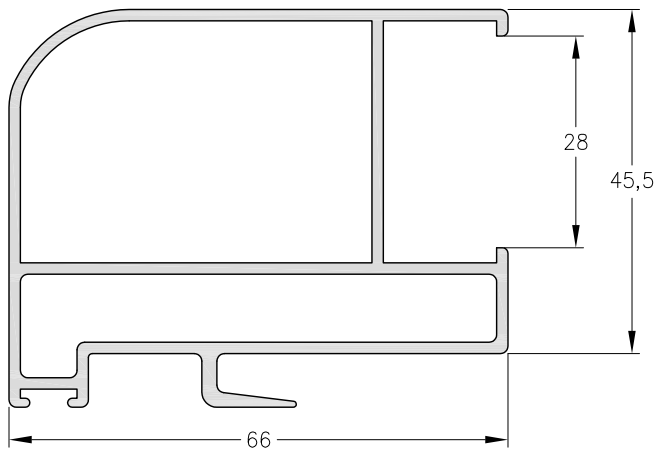

4082 - Parante ctral 3er hoja DVH.
Peso: 1.267 Kg/m.
Largo Std.: 6.200 mm.

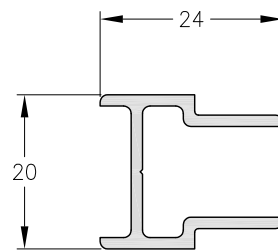

4965 - Encuentro central Corrediza 4 Hojas
Peso: 0,29 Kg/m.
Largo Std.: 6.200 mm.

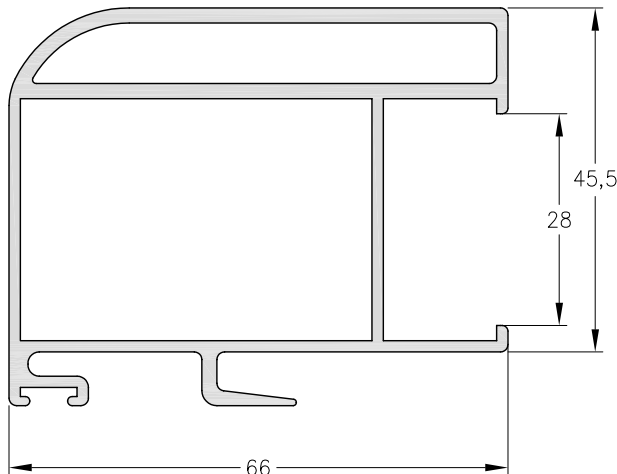

4072 - Parante central p/ DVH.
Peso: 1.466 Kg/m.
Largo Std.: 6.200 mm.
Largo Opc.: 4800 mm.

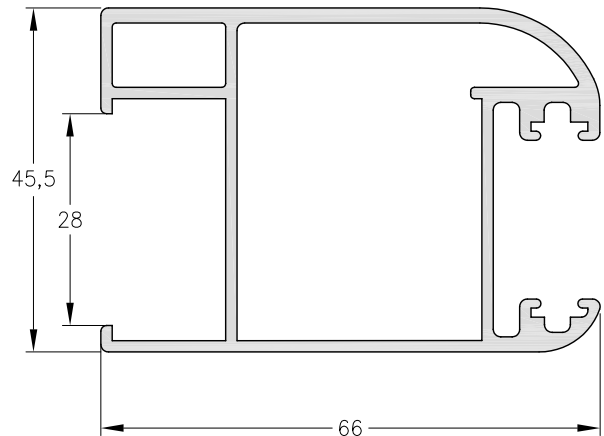

4071 - Parante lateral p/ DVH.
Peso: 1.291Kg/m.
Largo Std.: 6.200 mm.
Largo Opc.: 4800 mm.

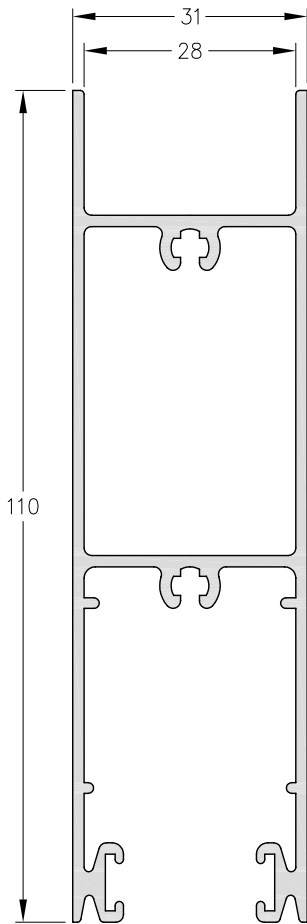

4074 - Zócalo alto p/ DVH.
Peso: 1.407 Kg/m.
Largo Std.: 6.200 mm.

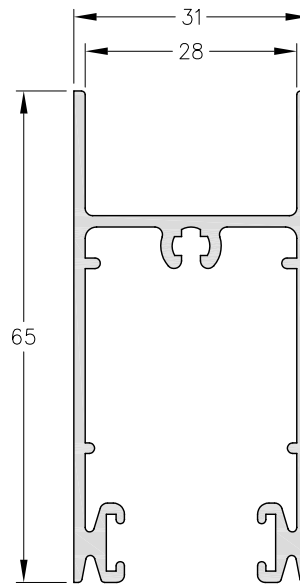

4073 - Zócalo y Cabezal p/ DVH.
Peso: 0.861 Kg/m.
Largo Std.: 6.200 mm.

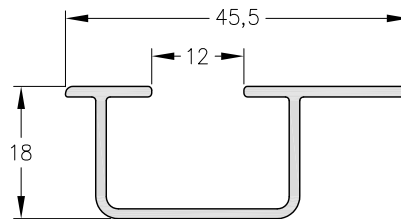

4001 - Adaptador VS en parantes.
Peso: 0.324 Kg/m.
Largo Std.: 6.200 mm.

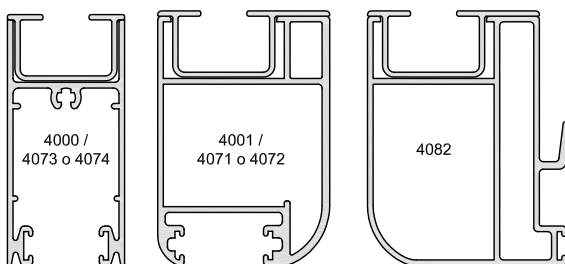

**Detalle de montaje de adaptadores
para Vidrio Simple
ESC. 2:1**

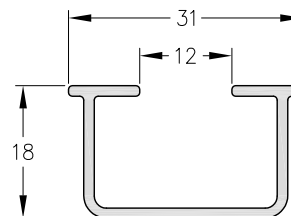

4000 - Adaptador VS en zócalo y dintel.
Peso: 0.261 Kg/m.
Largo Std.: 6.200 mm.

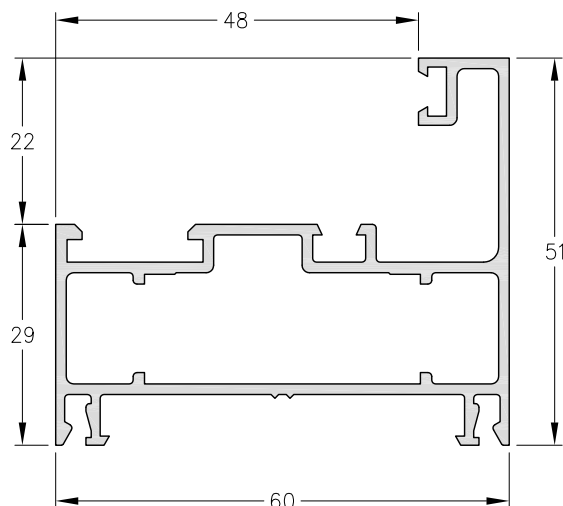

**4059 - Marco Paño Fijo Recto,
Ventana de Rebatir.
Peso: 1.001 Kg/m.
Largo Std.: 6.200 mm.**

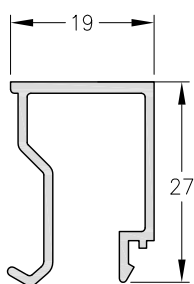

**4046 - Contravidrio
Recto P/DVH.
Peso: 0.273 Kg/m.
Largo Std.: 6.200 mm.**

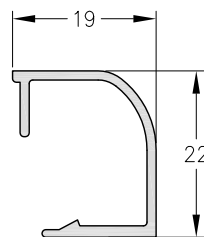

**4048 - Contravidrio
Curvo P/DVH.
Peso: 0.196 Kg/m.
Largo Std.: 6.200 mm.**

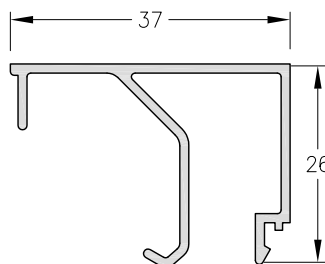

**4045 - Contravidrio
Recto 37 mm.
Peso: 0.351 Kg/m.
Largo Std.: 6.200 mm.**

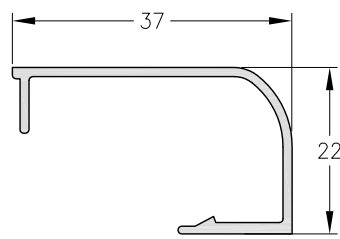

**4047 - Contravidrio
Curvo 37 mm.
Peso: 0.254 Kg/m.
Largo Std.: 6.200 mm.**

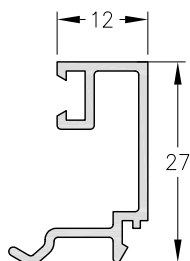

**4049 - Contravidrio
Recto L.E..
Peso: 0.232 Kg/m.
Largo Std.: 6.200 mm.**

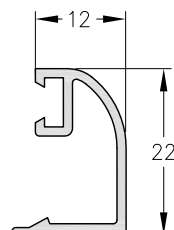

**4050 - Contravidrio
Curvo L.E..
Peso: 0.191 Kg/m.
Largo Std.: 6.200 mm.**

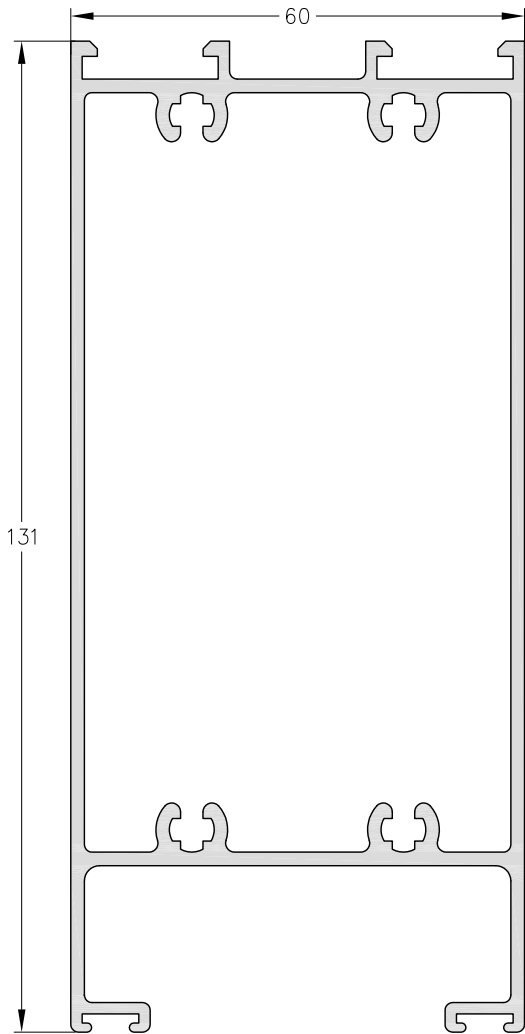

4043 - Zócalo Puerta
Peso: 2,32 Kg/m.
Largo Std.: 6.200 mm.

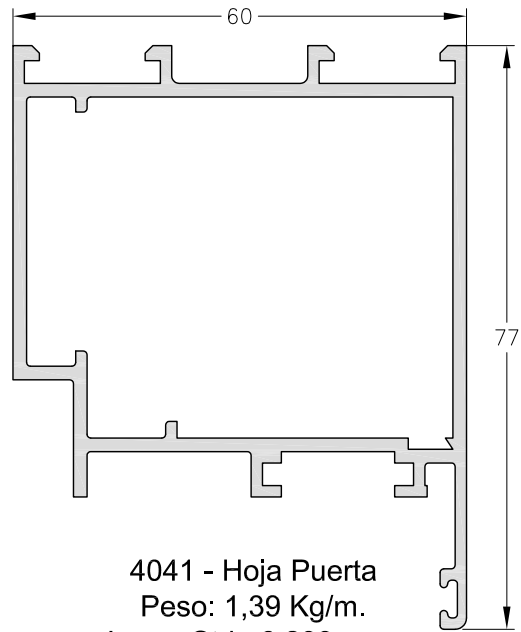

4041 - Hoja Puerta
Peso: 1,39 Kg/m.
Largo Std.: 6.200 mm.



4044 - Encuentro Central
Peso: 1,04 Kg/m.
Largo Std.: 6.200 mm.

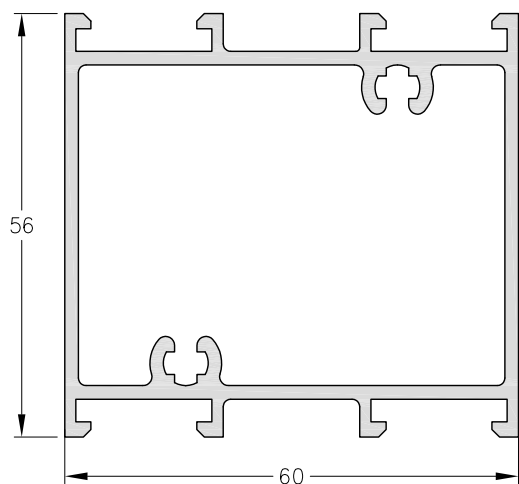

4042 - Travesaño
Peso: 1,40 Kg/m.
Largo Std.: 6.200 mm.

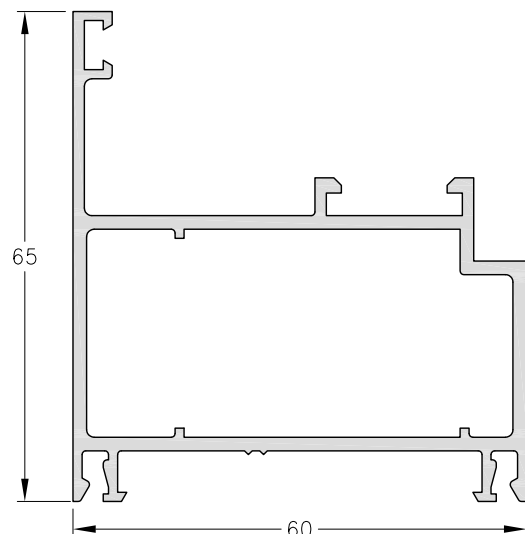

4040 - Marco Puerta
Peso: 1,18 Kg/m.
Largo Std.: 6.200 mm.

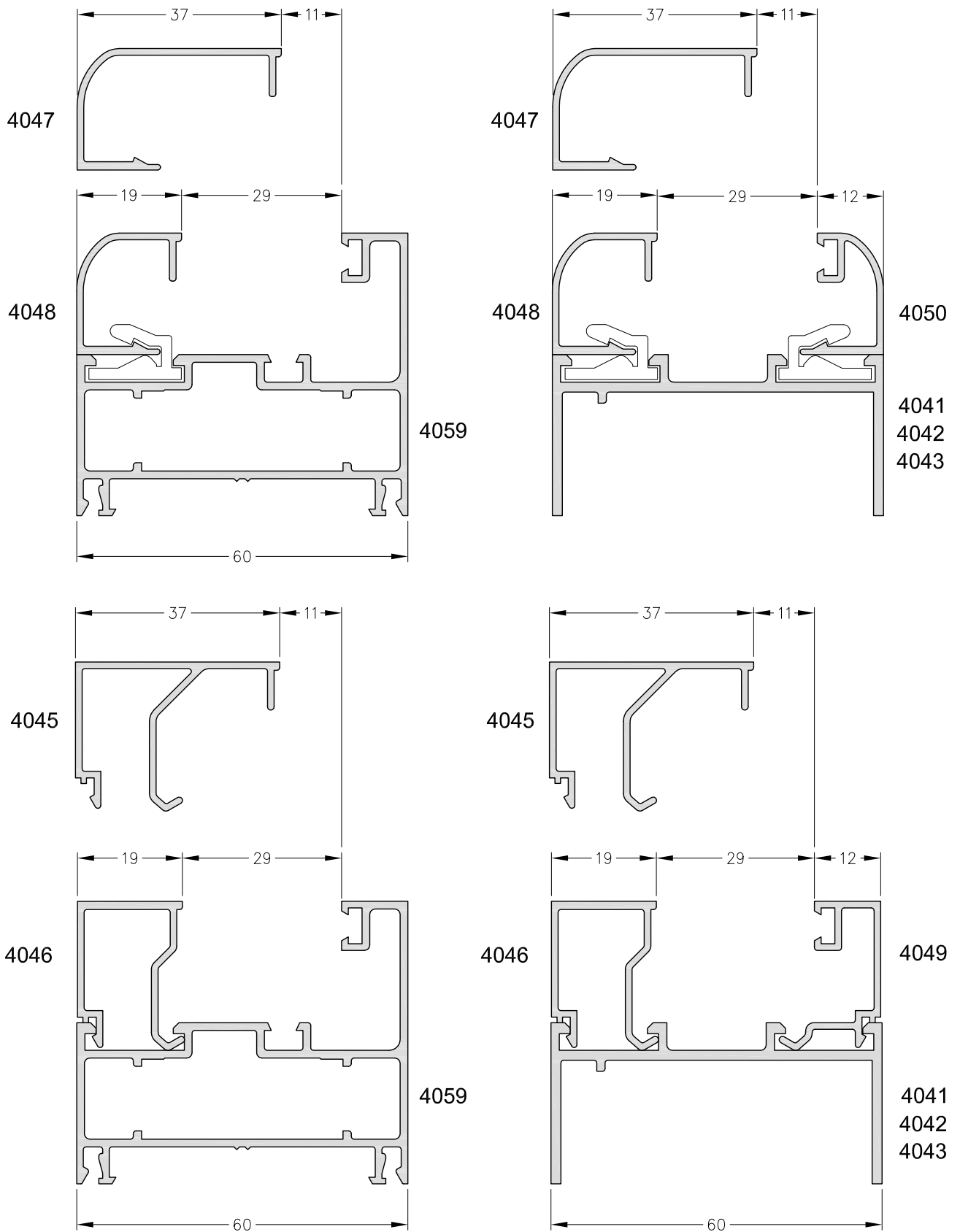

NOTA: Los contravidrios rectos se arman a 90°, y los contravidrios curvos con clip se arman a 45°

