















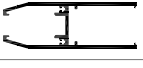



CATALOGO DE PERFILES SISTEMAS COMPLEMENTARIOS















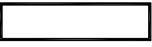







4	Índice de Perfiles
	Detalle de Perfiles en Escala 1:1
8	Baranda BBA
9	Blindex
10	Mampara de Baño 900 / Mampara Rebatible
11	Frente de Placard
12	Ángulos Normalizados
13	Tubos Normalizados / Planchuelas
17	Riel Corredizo Sup. R164 / Canales Lisos / Escuadras Universales
18	Revestimientos
19	Perfiles Fachadas Ventiladas / Base Parasol 25 mm























Peso de las Barras de Perfiles: El peso por metro de los perfiles es estimado, con una tolerancia de + / - 10%.

Largo de las Barras de Perfiles: La medida Standard de las Barras de Perfiles es de 6.030 milímetros, salvo aclaración en contrario.

Alsafex S.A. se reserva el derecho de realizar cambios y/o modificaciones sin previo aviso de los contenidos y artículos indicados en el presente catálogo.

CODIGO	PESO (Kg/m.)	LARGO (mm.)	DESCRIPCION	FORMA	PAG.
1090028	1,35	6.030	Pasamanos Curvo Baranda BBA		8
1090029	0,20	6.030	Tapa Inferior Pasamanos Baranda BBA		8
1090030	0,83	6.030	Parante Baranda BBA		8
0190031	0,38	6.030	Porta Blisan Inferior Baranda BBA		8
1090050	0,13	6.030	Planchuela 15,9 x 3 mm.		16
1090055	0,56	6.030	Escuadra Universal Intermedia		17
1090063	0,74	6.030	Escuadra Universal Pesada		17
1010097	0,64	6.030	Revestimiento Doble Faz		18
1090110	1,66	6.030	Zócalo Puerta Blindex		9
1090111	0,39	6.030	Suplemento Zócalo Blindex		9
1090114	0,98	6.030	Canal Liso 90 x 40 mm.		17
1090118	0,60	6.030	Canal Liso 75 x 25 mm.		17
1090124	0,64	6.030	Angulo 100 x 20 mm.		12
1090125	0,29	6.030	Angulo 60 x 12 mm.		12
1090155	0,53	5.200	Parante de 15 mm. Frente de Placard		11
1090156	0,16	6.030	Cantonera de 15 mm. Frente de Placard		11
1090157	0,25	6.030	Guía Inferior Frente de Placard		11
1090158	0,20	6.030	Cantonera de 18 mm. Frente de Placard		11
1090159	0,54	5.200	Parante de 18 mm. Frente de Placard		11
1090160	0,68	6.030	Guía Superior Frente de Placard		11
1090201	0,52	6.030	Marco Mampara Rebatible		10
1090202	0,57	6.030	Porta Hoja Mampara Rebatible		10
1090203	0,64	6.030	Hoja Mampara Rebatible		10

CODIGO	PESO (Kg/m.)	LARGO (mm.)	DESCRIPCION	FORMA	PAG.
1010398	0,84	6.030	Revestimiento Tubular		18
1090454	1,27	6.030	Tubo Rectangular 100 x 50 mm.		14
1090457	0,90	6.030	Tubo Rectangular 75 x 25 mm.		14
1090458	1,23	6.030	Tubo Rectangular 90 x 40 mm.		14
1090459	1,01	6.030	Tubo Cuadrado 60 x 60 mm.		15
1090461	0,99	6.030	Tubo Rectangular de 100 x 25 mm.		14
1090464	1,12	6.030	Tubo Rectangular de 75 x 50 mm.		13
1090466	0,17	6.030	U de 11,1 x 22 mm		9
1090472	1,58	6.030	Tubo Rectangular de 150 x 25 mm.		14
1090587	0,15	6.030	Tubo Cuadrado 12,7 x 12,7 mm.		16
1090630	0,64	6.030	Base Parasol 25 mm		19
1090631	0,28	6.030	Clip Parasol 25 mm		19
1090650	0,25	6.030	"U" de Blindex		10
1090700	2,68	6.150	Tubo Cuadrado 115 x 115 mm.		15
1090751	0,08	6.030	Angulo 12,7 x 12,7 mm.		12
1090752	0,10	6.030	Angulo 15 x 15 mm.		12
1090753	0,14	6.030	Angulo 19 x 19 mm.		12
1090755	0,16	6.030	Angulo 25,4 x 25,4 mm.		12
1090756	0,34	6.030	Angulo 32 x 32 mm.		12
1090757	0,34	6.030	Angulo 38 x 38 mm.		12
1090758	0,30	6.030	Angulo 50 x 25 mm.		12
1090759	0,79	6.030	Angulo 50 x 50 mm.		12
1090804	0,36	6.030	Tubo Cuadrado 25 x 25 mm.		16

CODIGO	PESO (Kg/m.)	LARGO (mm.)	DESCRIPCION	FORMA	PAG.
1090805	0,46	6.030	Tubo Rectangular 40 x 20 mm.		13
1090806	0,40	6.030	Tubo Cuadrado 30 x 30 mm.		16
1090807	0,63	6.030	Tubo Cuadrado 38 x 38 mm.		16
1090808	0,71	6.030	Tubo Cuadrado 45 x 45 mm.		16
1090809	0,55	6.030	Tubo Rectangular 50 x 25 mm.		14
1090810	0,32	6.030	Tubo Rectangular 30 x 12 mm.		13
1090811	0,79	6.030	Tubo Cuadrado 50 x 50 mm.		16
1090812	0,63	6.030	Tubo Rectangular 60 x 20 mm.		13
1090813	0,68	6.030	Tubo Rectangular 60 x 30 mm.		14
1090830	0,16	6.030	Perfil "T" 25 x 25 mm.		12
1090941	0,82	6.030	Cabezal Mampara de Baño 900		10
1090942	0,37	6.030	Umbral Mampara de Baño 900		10
1090943	0,32	6.030	Jamba Mampara de Baño 900		10
1090944	0,35	6.030	Hoja Mampara de Baño 900		10
1090946	0,24	6.030	Barra Toallera		10
1090970	2,00	6.030	Tubo Rectangular 110 x 54 mm.		13
1090995	0,31	6.030	Caño Redondo Ø 25,4 mm.		16
1090996	0,47	6.030	Caño Redondo Ø 38,1 mm.		16
1090997	0,63	6.030	Caño Redondo Ø 50,8 mm.		9
3014	0,173	6.030	Barra Cuadrada 8 mm.		16
3025	1.243	6.030	Pasamanos Recto Baranda BBA.		8
3033	0,25	6.030	Tubo Cuadrado 20 x 20 mm.		16
3043	0,46	6.030	U 40 x 20 mm		9

CODIGO	PESO (Kg/m.)	LARGO (mm.)	DESCRIPCION	FORMA	PAG.
3077	0,73	6.030	Perfil Montante "T" Fachada Ventilada		19
3078	0,67	6.030	Perfil Bandeja "Z" Fachada Ventilada		19
3079	0,64	6.030	Perfil Bandeja "S" Fachada Ventilada		19
3081	0,38	6.030	Tubo Rectangular 30 x 20 mm.		13
3082	0,86	6.030	Riel Superior tipo ROMA 164		17
3084	0,97	6.030	Revestimiento Tubular E27 mm		18
3085	0,18	6.030	Caño Redondo Ø 22,22 mm		16
3112	1,20	6.200	Revestimiento 25 - 23 - 23 mm		18

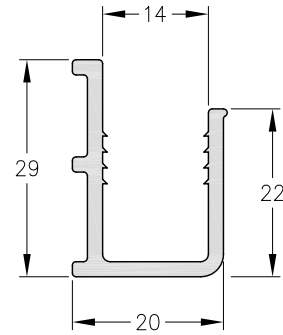
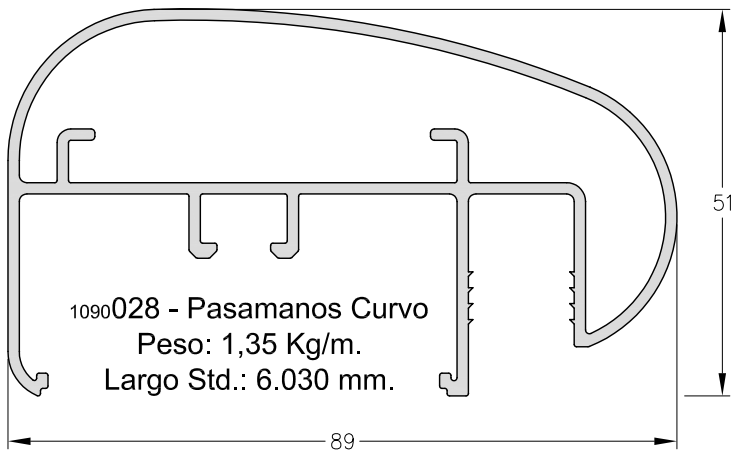

1090031 - Porta Blisan Inferior
Peso: 0,38 Kg/m.
Largo Std.: 6.030 mm.

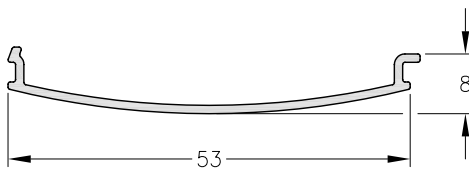
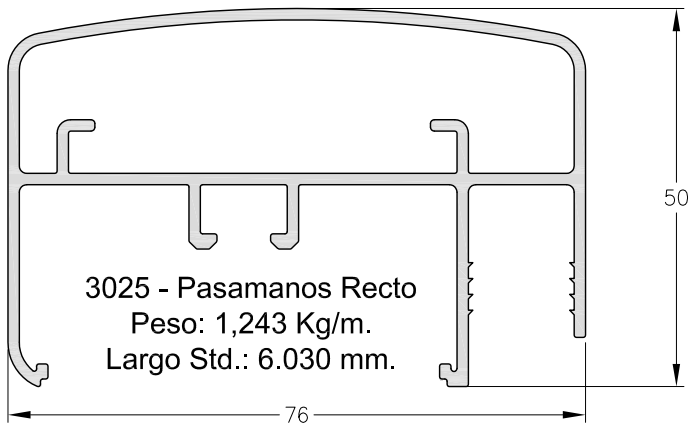

1090029 - Tapa Inferior Pasamanos Curvo
Peso: 0,20 Kg/m.
Largo Std.: 6.030 mm.

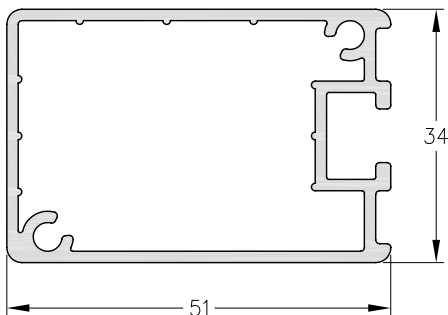

1090030 - Parante
Peso: 0,83 Kg/m.
Largo Std.: 6.030 mm.

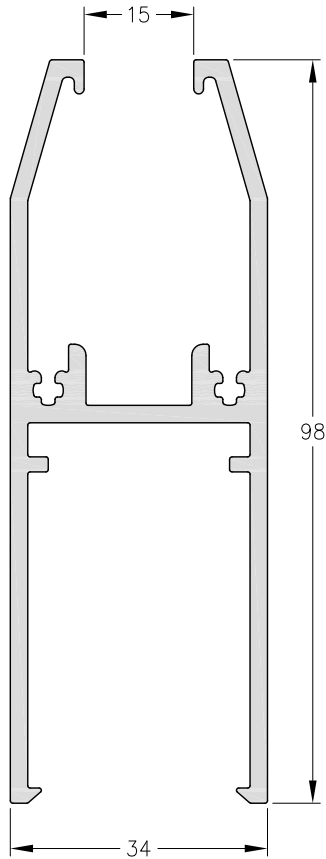

1090110 - Zócalo
Peso: 1,66 Kg/m.
Largo Std.: 6.030 mm.

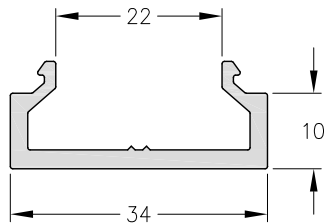

1090111 - Suplemento Zócalo
Peso: 0,39 Kg/m.
Largo Std.: 6.030 mm.

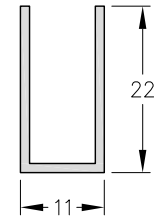

1090466 - "U" 11,1 x 22 mm
Peso: 0,17 Kg/m.
Largo Std.: 6.030 mm.

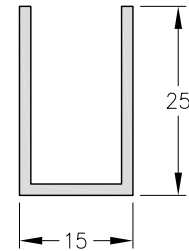

1090650 - "U" de Blindex
Peso: 0,25 Kg/m.
Largo Std.: 6.030 mm.

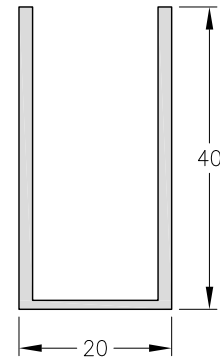

3043 - "U" 40 x 20 mm
Peso: 0,46 Kg/m.
Largo Std.: 6.030 mm.

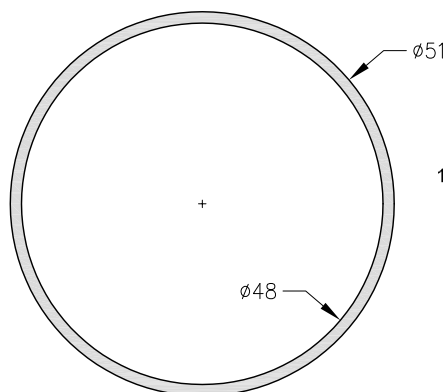

1090997 - Caño Redondo
Peso: 0,63 Kg/m.
Largo Std.: 6.030 mm.

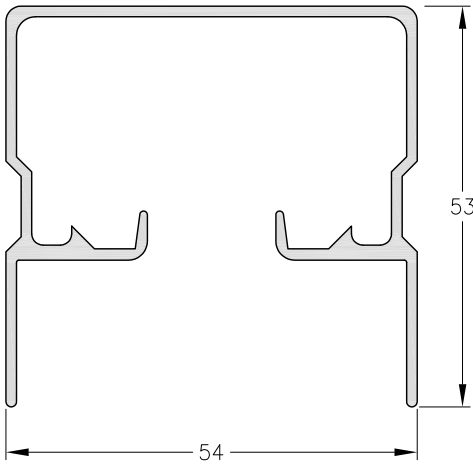

1090941 - Cabezal
Peso: 0,82 Kg/m.
Largo Std.: 6.030 mm.

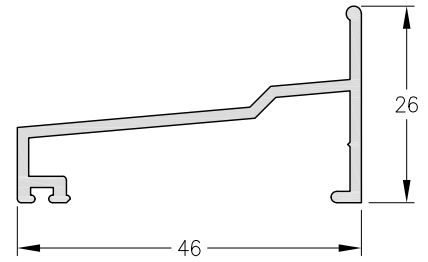

1090942 - Umbral
Peso: 0,37 Kg/m.
Largo Std.: 6.030 mm.

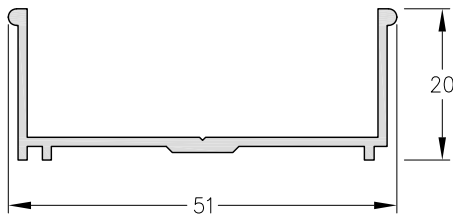

1090943 - Jamba
Peso: 0,32 Kg/m.
Largo Std.: 6.030 mm.

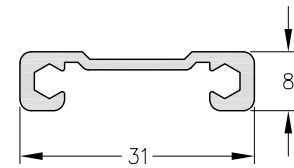

1090946 - Barra Toallera
Peso: 0,24 Kg/m.
Largo Std.: 6.030 mm.

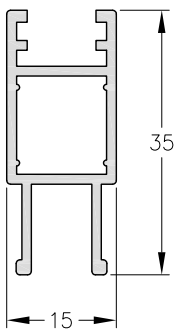

1090944 - Hoja
Peso: 0,35 Kg/m.
Largo Std.: 6.030 mm.

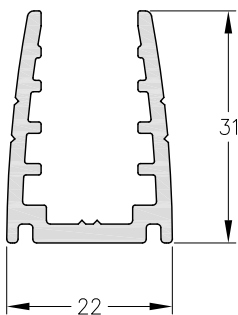

1090201 - Marco
Peso: 0,52 Kg/m.
Largo Std.: 6.030 mm.

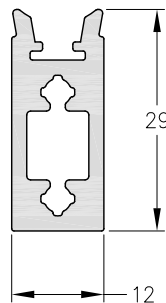

1090202 - Porta Hoja
Peso: 0,57 Kg/m.
Largo Std.: 6.030 mm.

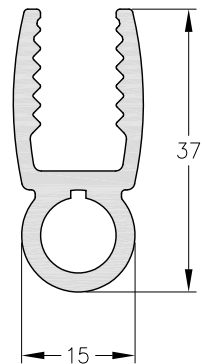

1090203 - Hoja
Peso: 0,64 Kg/m.
Largo Std.: 6.030 mm.

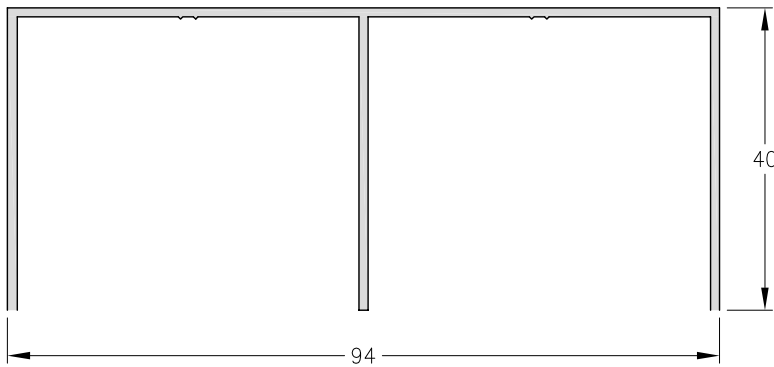

1090160 - Guía Superior
Peso: 0,68 Kg/m.
Largo Std.: 6.030 mm.

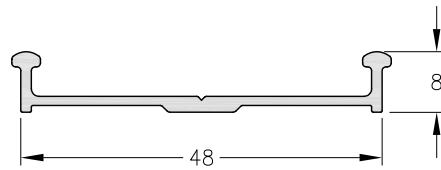

1090157 - Guía Inferior
Peso: 0,25 Kg/m.
Largo Std.: 6.030 mm.

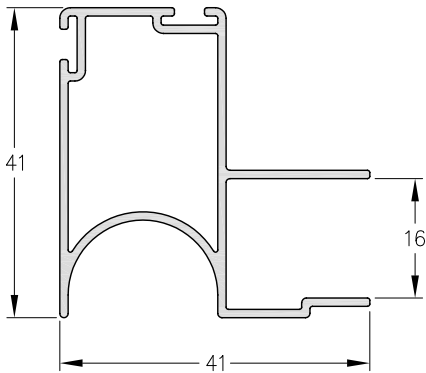

1090155 - Parante de 15 mm.
Peso: 0,53 Kg/m.
Largo Std.: 5.200 mm.

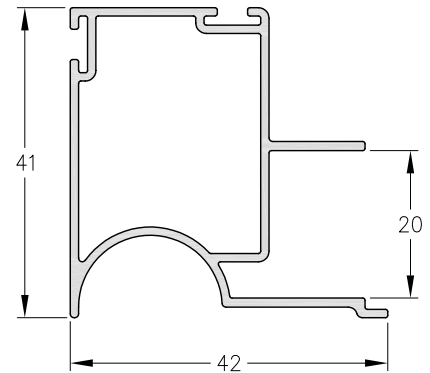

1090159 - Parante de 18 mm.
Peso: 0,54 Kg/m.
Largo Std.: 5.200 mm.

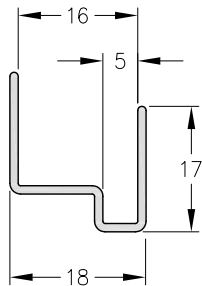

1090156 - Cantonera de 15 mm.
Peso: 0,16 Kg/m.
Largo Std.: 6.030 mm.

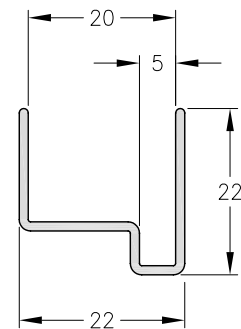

1090158 - Cantonera de 18 mm.
Peso: 0,20 Kg/m.
Largo Std.: 6.030 mm.

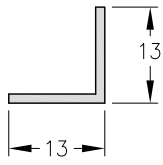

1090751 - Perfil Angulo
 Peso: 0,08 Kg/m.
 Largo Std.: 6.030 mm.

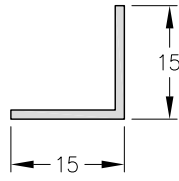

1090752 - Perfil Angulo
 Peso: 0,10 Kg/m.
 Largo Std.: 6.030 mm.

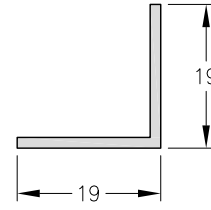

1090753 - Perfil Angulo
 Peso: 0,14 Kg/m.
 Largo Std.: 6.030 mm.

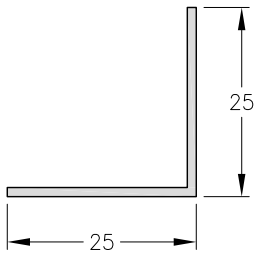

1090755 - Perfil Angulo
 Peso: 0,16 Kg/m.
 Largo Std.: 6.030 mm.

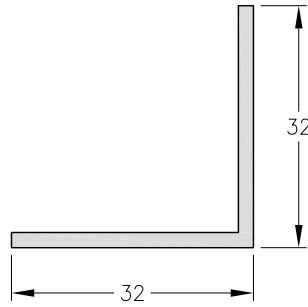

1090756 - Perfil Angulo
 Peso: 0,34 Kg/m.
 Largo Std.: 6.030 mm.

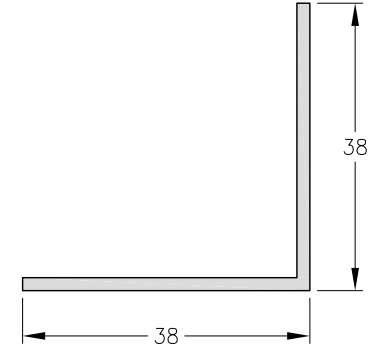

1090757 - Perfil Angulo
 Peso: 0,34 Kg/m.
 Largo Std.: 6.030 mm.

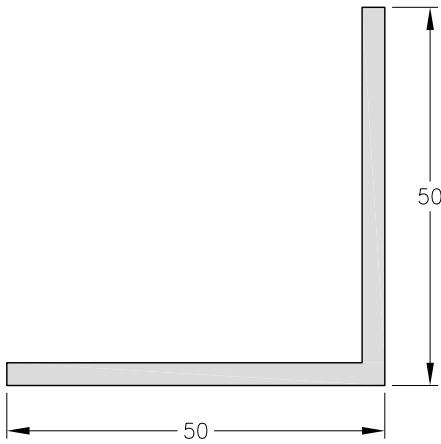

1090759 - Perfil Angulo
 Peso: 0,79 Kg/m.
 Largo Std.: 6.030 mm.

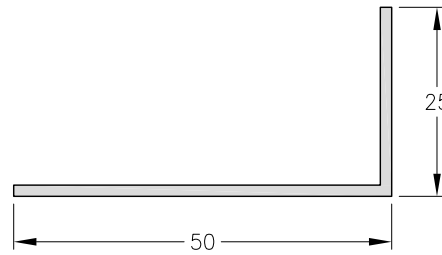

1090758 - Perfil Angulo
 Peso: 0,30 Kg/m.
 Largo Std.: 6.030 mm.

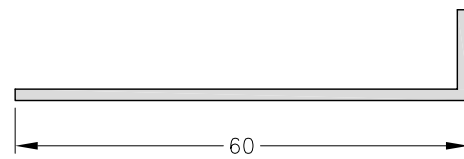

1090125 - Perfil Angulo
 Peso: 0,29 Kg/m.
 Largo Std.: 6.030 mm.

1090124 - Perfil Angulo
 Peso: 0,64 Kg/m.
 Largo Std.: 6.030 mm.

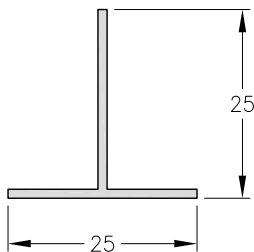
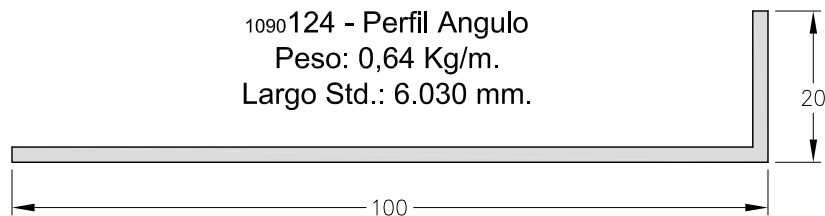

1090830 - Perfil T
 Peso: 0,16 Kg/m.
 Largo Std.: 6.030 mm.

Perfil	Espesor	Perfil	Espesor	Perfil	Espesor
1090124	2 mm.	1090753	1,4 mm.	1090758	1,5 mm.
1090125	1,5 mm.	1090755	1,2 mm.	1090759	3 mm.
1090751	1,2 mm.	1090756	2 mm.	1090830	1,2 mm.
1090752	1,2 mm.	1090757	1,7 mm.		

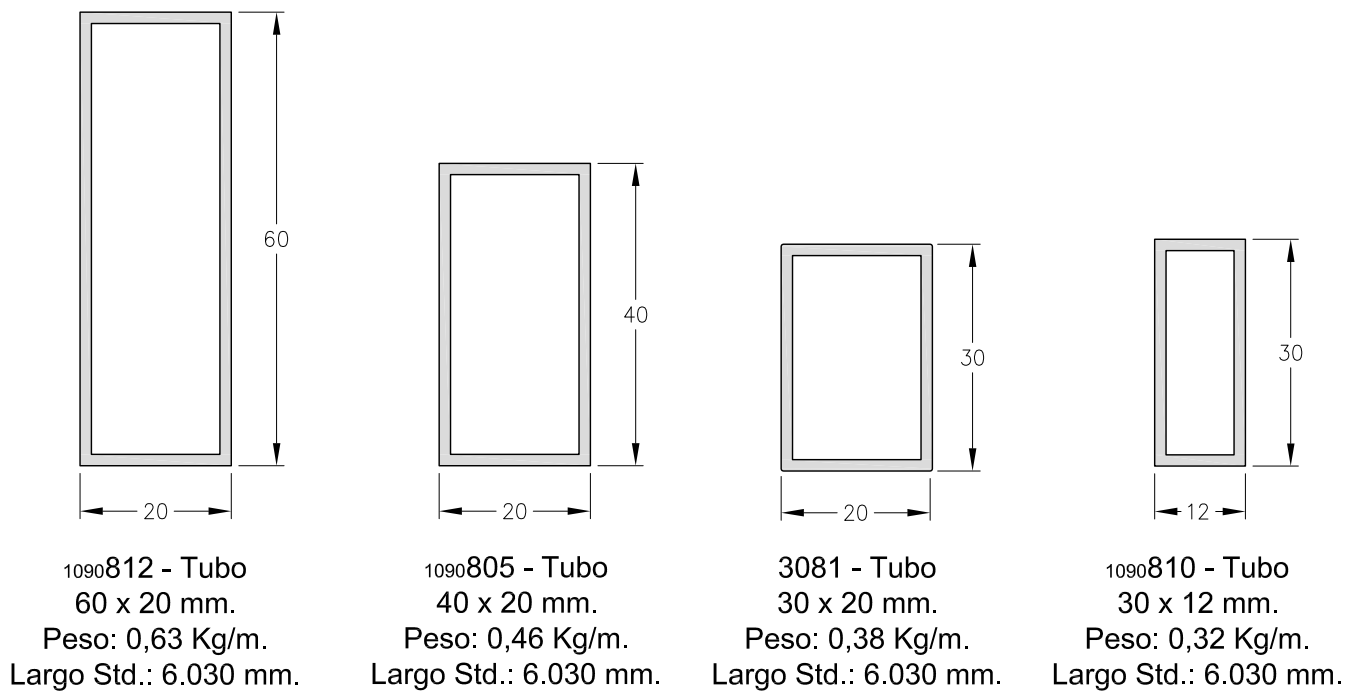
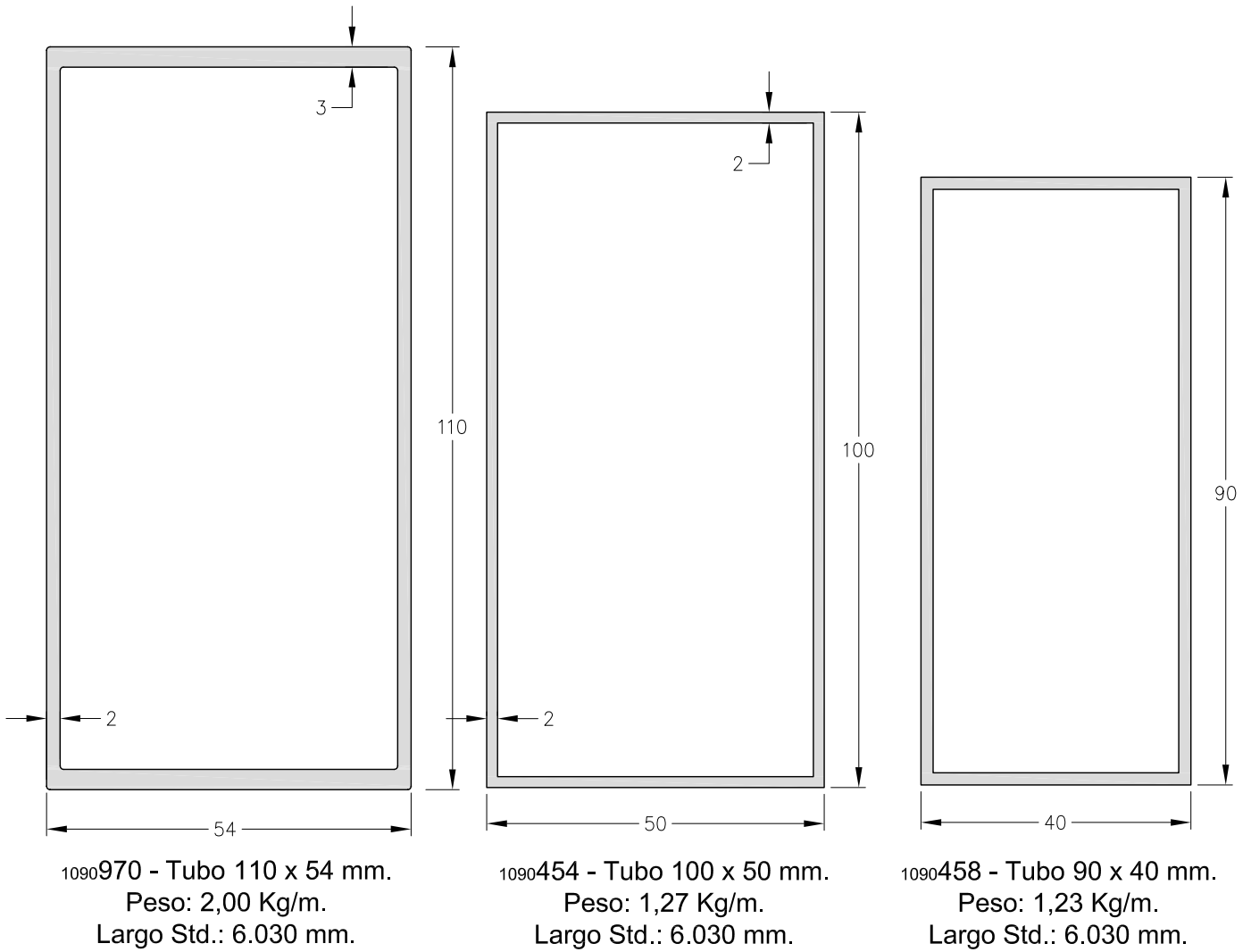

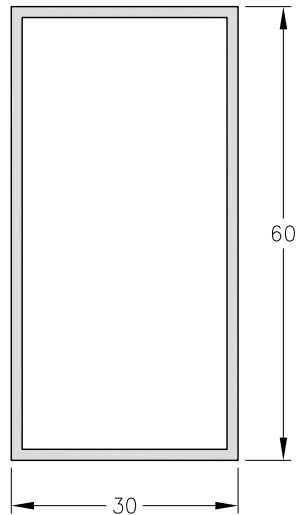

1090813 - Tubo
60 x 30 mm.
Peso: 0,68 Kg/m.
Largo Std.: 6.030 mm.

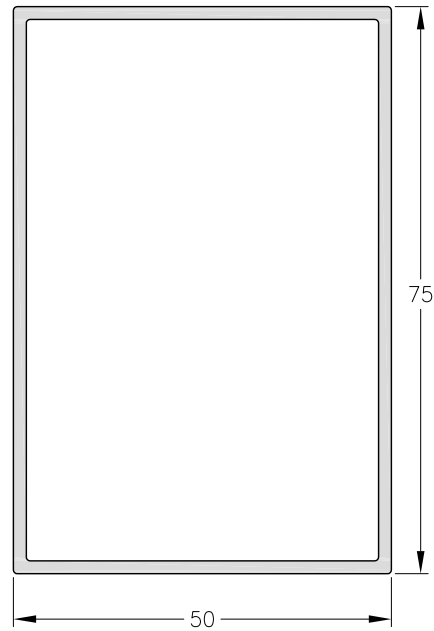

1090464 - Tubo 75 x 50 mm.
Peso: 1,12 Kg/m.
Largo Std.: 6.030 mm.

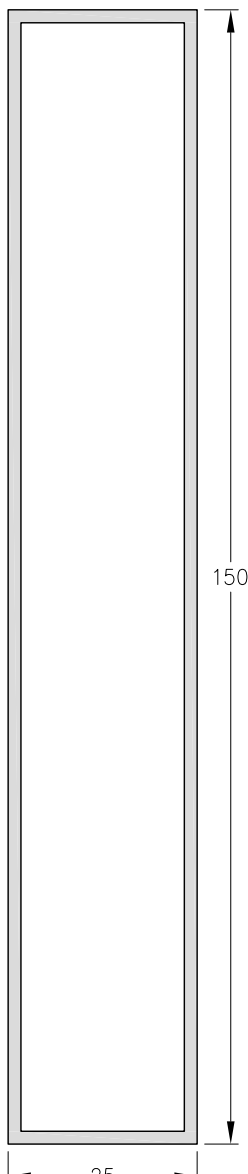

1090472 - Tubo
150 x 25 mm.
Peso: 1,58 Kg/m.
Largo Std.: 6.030 mm.

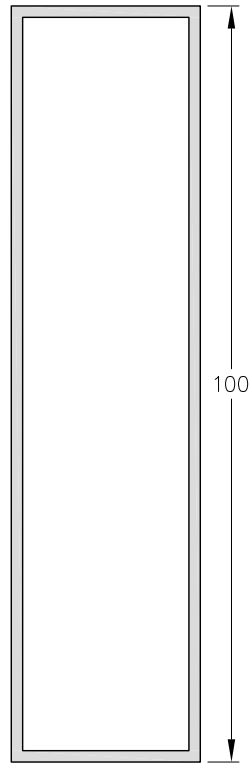

1090461 - Tubo
100 x 25 mm.
Peso: 0,99 Kg/m.
Largo Std.: 6.030 mm.

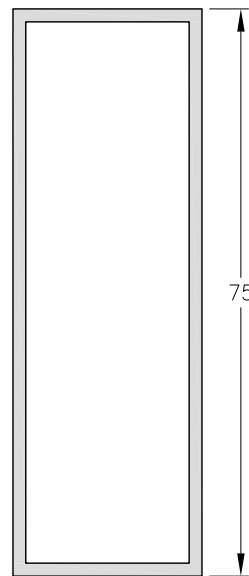

1090457 - Tubo
75 x 25 mm.
Peso: 0,90 Kg/m.
Largo Std.: 6.030 mm.

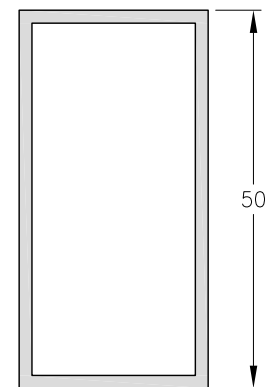

1090809 - Tubo
50 x 25 mm.
Peso: 0,55 Kg/m.
Largo Std.: 6.030 mm.

Escala 1:1

Tolerancia en Peso +/- 10%

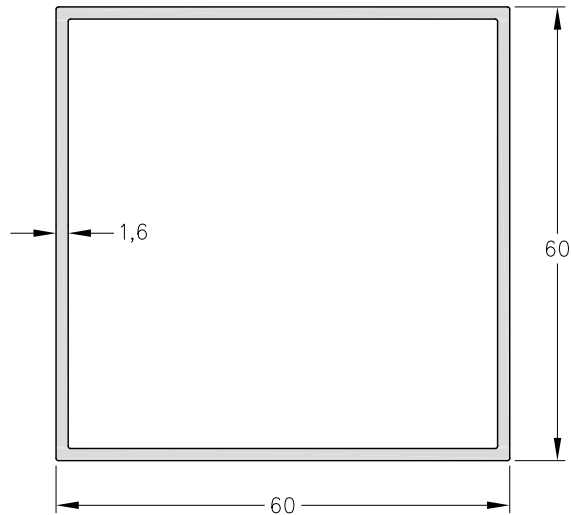

1090459 - Tubo 60 x 60 mm.
Peso: 1,01 Kg/m.
Largo Std.: 6.030 mm.

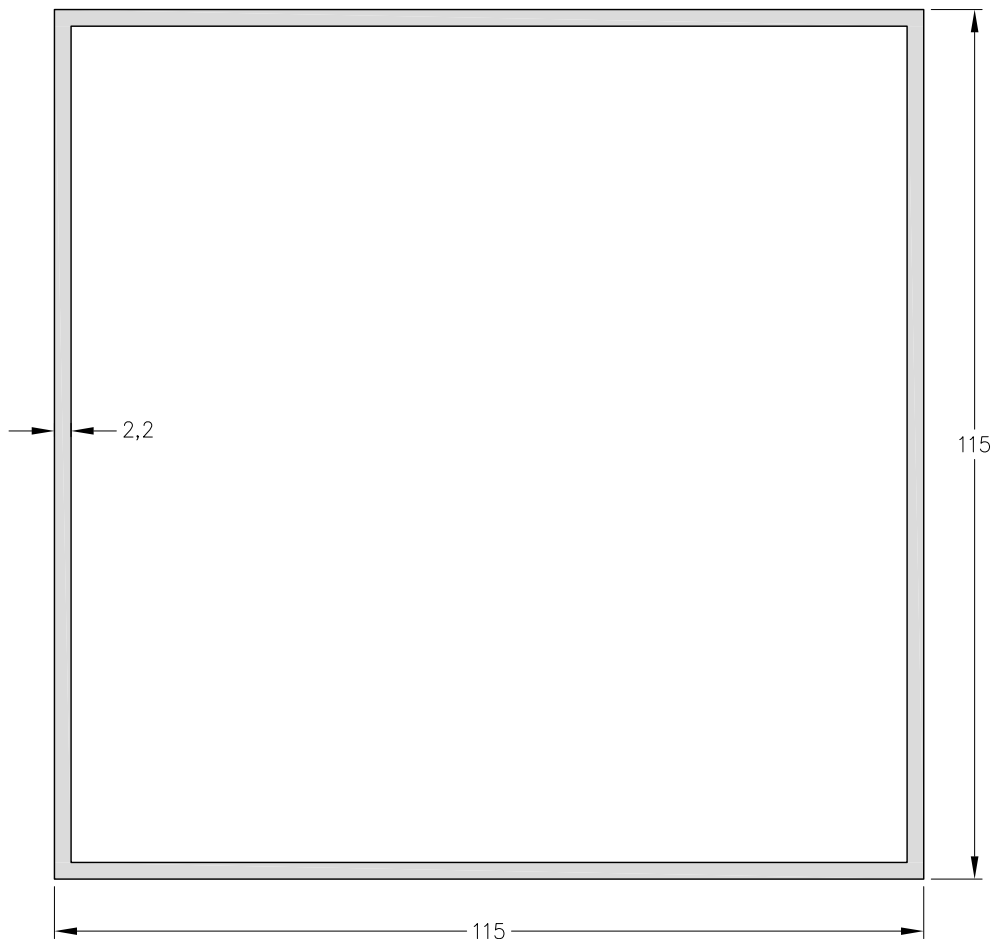

1090700 - Tubo 115 x 115 mm.
Peso: 2,68 Kg/m.
Largo Std.: 6.150 mm.

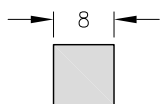
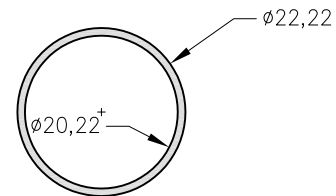
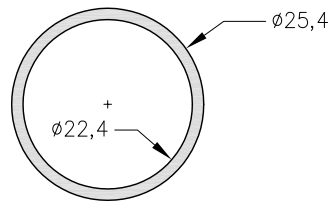
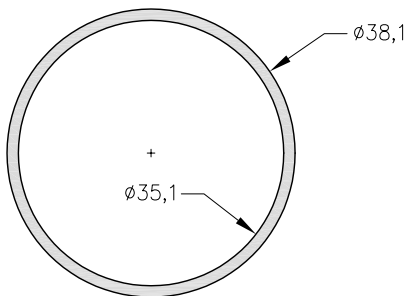
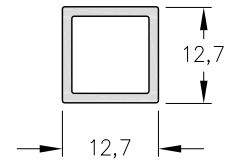
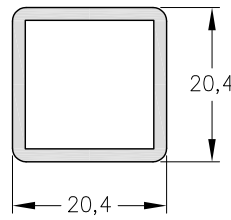
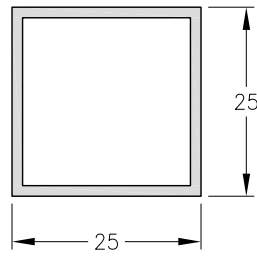
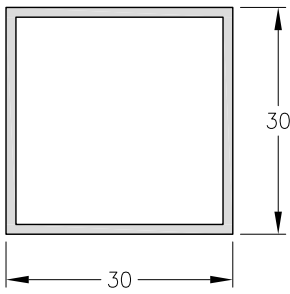
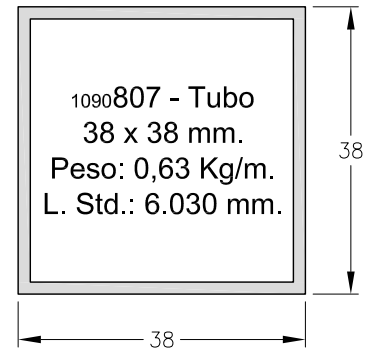
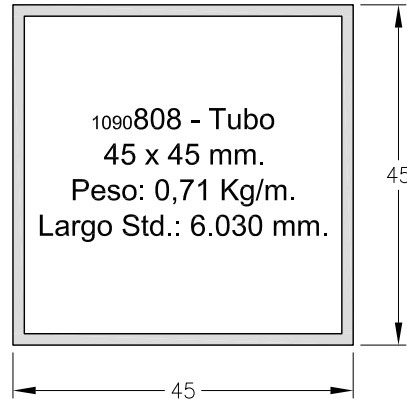
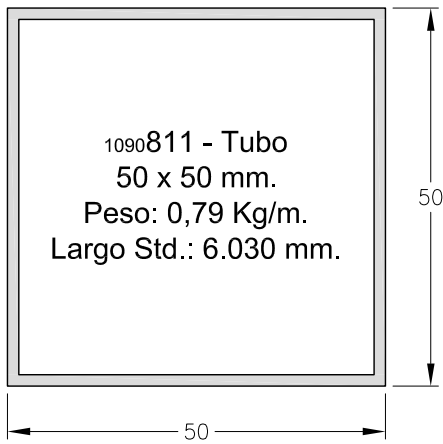

Perfil	Espesor	Perfil	Espesor	Perfil	Espesor
1090457	1,7 mm.	1090804	1,4 mm.	1090810	1,5 mm.
1090458	1,8 mm.	1090805	1,5 mm.	1090811	1,5 mm.
1090461	1,5 mm.	1090806	1,3 mm.	1090812	1,5 mm.
1090464	1,7 mm.	1090807	1,6 mm.	3033	1,7 mm.
1090472	1,7 mm.	1090808	1,5 mm.	3081	1,5 mm.
1090587	1,25 mm.	1090809	1,5 mm.	3085	1,0 mm.

Escala 1:1
Tolerancia en Peso +/- 10%

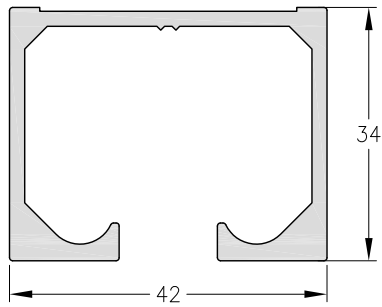

3082 - Riel Corredizo Sup. R164
 Peso: 0,86 Kg/m.
 Largo Std.: 6.030 mm.

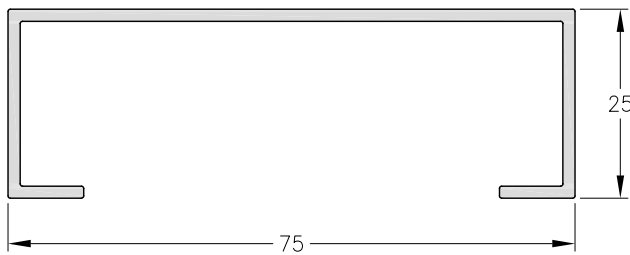

1090118 - Canal Liso 75 x 25 mm.
 Peso: 0,60 Kg/m.
 Largo Std.: 6.030 mm.

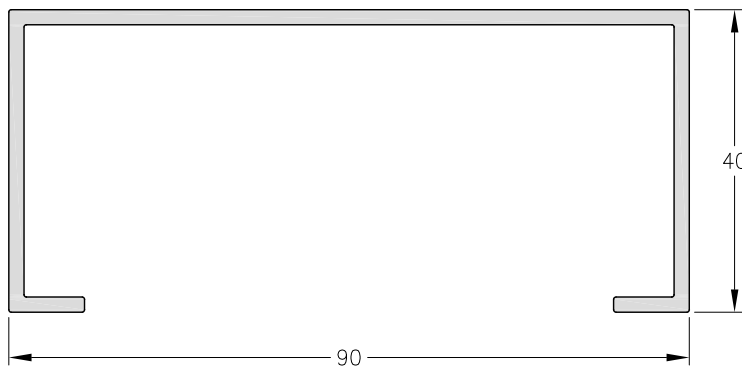

1090114 - Canal Liso 90 x 40 mm.
 Peso: 0,98 Kg/m.
 Largo Std.: 6.030 mm.

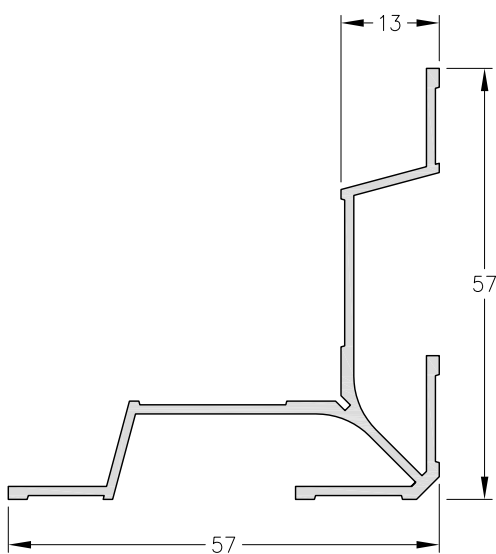

1090055 - Escuadra Universal Intermedia
 Peso: 0,56 Kg/m.
 Largo Std.: 6.030 mm.

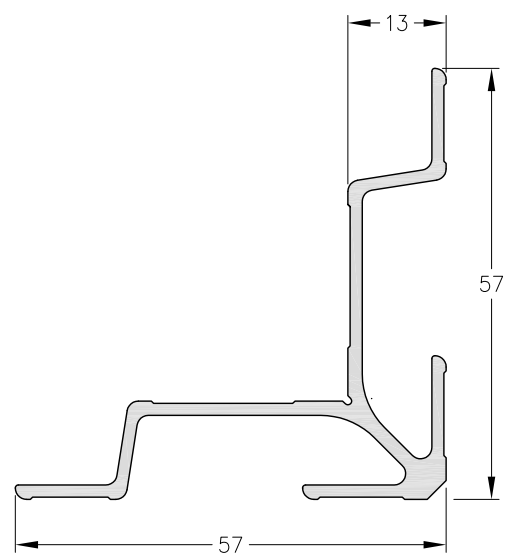

1090063 - Escuadra Universal Pesada
 Peso: 0,74 Kg/m.
 Largo Std.: 6.030 mm.

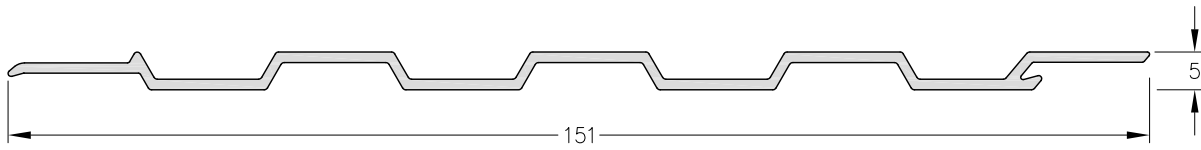

1010097 - Revestimiento Doble Faz
Peso: 0,64 Kg/m.
Largo Std.: 6.030 mm.

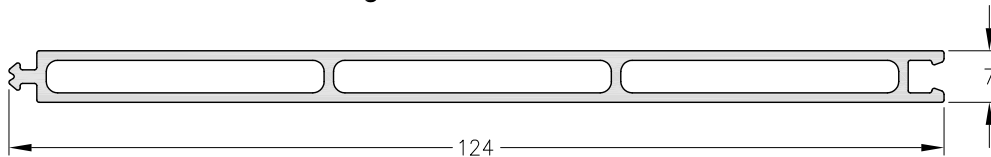

1010398 - Revestimiento Tubular
Peso: 0,91 Kg/m.
Largo Std.: 6.030 mm.

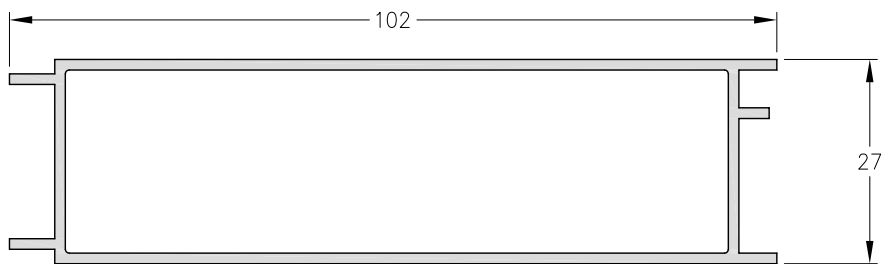

3084 - Revestimiento Tubular E27 mm.
Peso: 0,97 Kg/m.
Largo Std.: 6.030 mm.

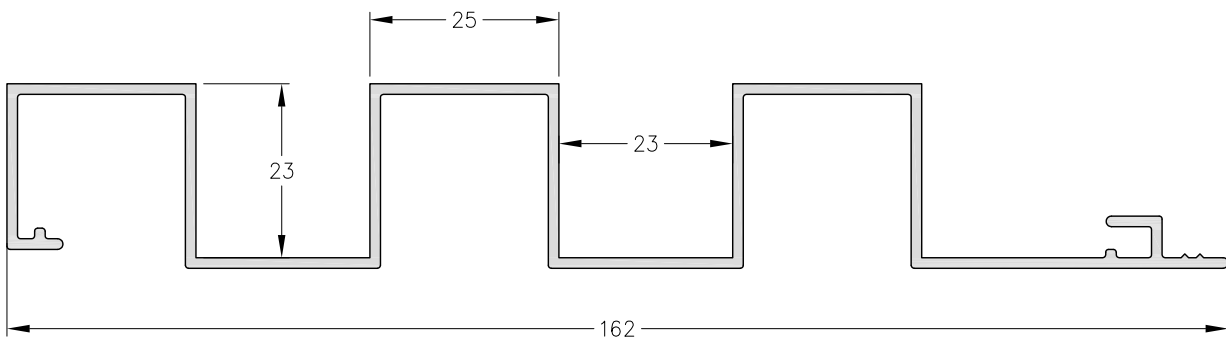

3112 - Revestimiento 25 - 23 - 23
Peso: 1,20 Kg/m.
Largo Std.: 6.200 mm.

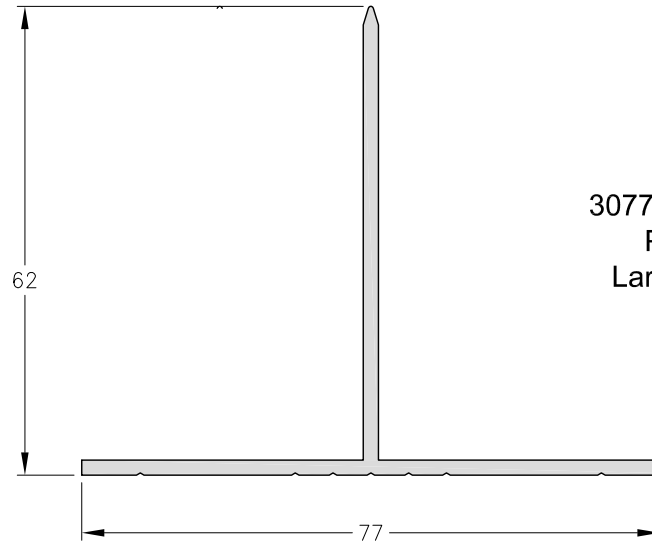

3077 - Perfil Montante "T"
Peso: 0,73 Kg/m.
Largo Std.: 6.030 mm.

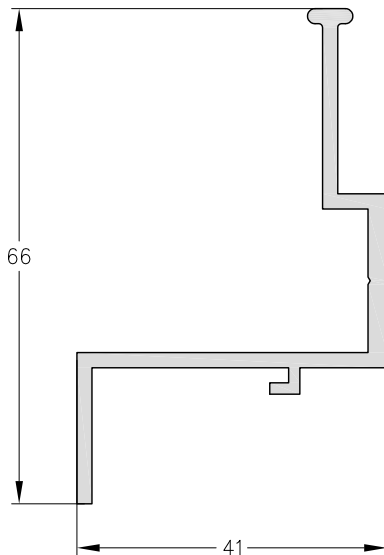

3078 - Perfil Bandeja "Z"
Peso: 0,67 Kg/m.
Largo Std.: 6.030 mm.

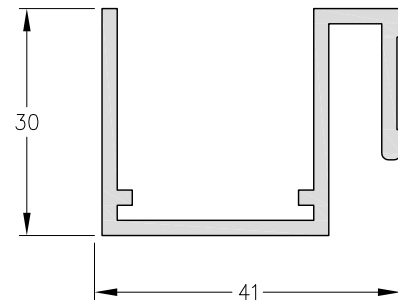

3079 - Perfil Bandeja "S"
Peso: 0,64 Kg/m.
Largo Std.: 6.030 mm.

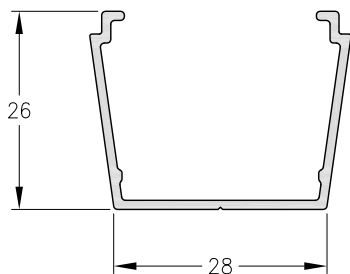

1090631 - CLIP Parasol 25 mm
Largo Std.: 6030 mm
peso: 0,279 Kg/m

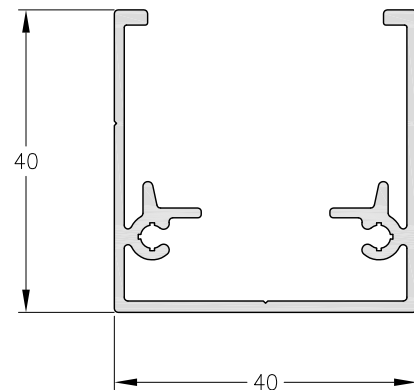

1090630 - Base Parasol 25 mm
Largo Std.: 6030 mm
peso: 0,642 Kg/m