

CATALOGO DE PERFILES SISTEMA MEDITERRANEA

4	Índice de Perfiles
10	Tabla de Tipologías
	Detalle de Perfiles en Escala 1:1
	Mediterránea M-Uno
11	Ventana y Puerta Corrediza - Hoja a 45°
12	Ventana y Puerta Corrediza - Hoja a 90°
	Mediterránea M-Tres
14	Ventana y Puerta Corrediza / Mosquitero
17	Ventana de Rebatir / Oscilo-Batiente / Puerta de Rebatir M-Arq. C-16
18	Paño Fijo / Marco No-Coplanar y Coplanar / Ventana de Rebatir / Oscilo-Batiente /Banderola
19	Puerta de Rebatir
20	Ventana Desplazable a Tijera / Travesaños
	Mediterránea M-Cinco
21	Ventana y Puerta Corrediza
23	Puerta Vaivén / Paño Fijo
24	Puerta de Rebatir
	Mediterránea M-Siete
26	Ventana y Puerta Corrediza / Corrediza-Elevable / Mosquitero
	Perfiles Varios
28	Contravidrios / Vidrio Repartido
29	Guías y Tapacinas de Cortinas / Pletinas
30	Premarcos / Contramarcos / Perfiles de Terminación
31	Acoples / Columnas

La Línea Mediterránea ofrece cuatro niveles de prestación:

M-Uno: Media prestación para dimensiones convencionales

M-Tres: Alta prestación para dimensiones convencionales











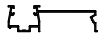
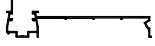



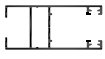
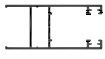
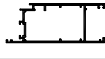



M-Cinco: Alta prestación para grandes dimensiones

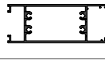



















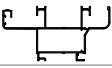

M-Siete: Alta prestación reforzada para grandes dimensiones



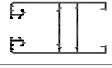







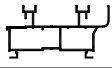
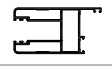
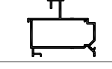
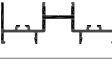



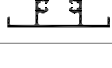
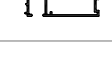
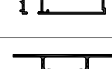

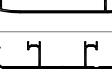
Peso de las Barras de Perfiles: El peso por metro de los perfiles es estimado, con una tolerancia de + / - 10%.



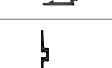



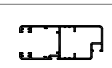









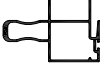
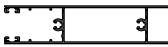

Largo de las Barras de Perfiles: La medida Standard de las Barras de Perfiles es de 6.030 milímetros, salvo aclaración en contrario.







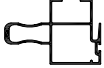

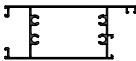

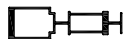

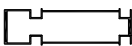
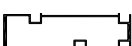



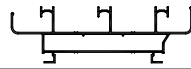
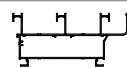

Alsafex S.A. se reserva el derecho de realizar cambios y/o modificaciones sin previo aviso de los contenidos y artículos indicados en el presente catálogo.

CODIGO	PESO (Kg/m.)	LARGO (mm.)	DESCRIPCION	FORMA	PAG.
1060108	0,47	6.030	Hoja de Mosquitero Ventana y Puerta Corrediza M-Tres		14
1060153	0,70	6.150	Guia de Cortina Común		29
1060154	1.02	6.150	Guia de Cortina Regulable (Barrio)		29
1060200	0,15	6.030	Bota-Agua Puerta de Rebatir M-Tres y M-Cinco		24
1060310	0,07	6.150	Tapa Terminación Coplanar Marco		30
1060380	0,22	6.030	Contravidrio Curvo de 28 mm.		28
1060405	0,72	6.030	Hoja perimetral Ventana y Puerta Corrediza VS N-Uno		11
1060406	0,68	6.030	Hoja perimetral Ventana y Puerta Corrediza DVH N-Uno		11
1060500	2,17	6.150	Cabezal y Parante Reforzado Puerta de Rebatir M-Cinco		25
1060518	1,00	6.030	Refuerzo Parantes Corredizas M-Uno, M-Tres y M-Cinco		16
1060523	0,17	6.030	Contravidrio Curvo de 16 mm.		28
1060525	0,19	6.030	Contravidrio Curvo de 20 mm.		28
1060526	0,15	6.030	Contravidrio Curvo de 8 mm.		28
1060540	0,15	6.030	Tapa Soporte Paño Fijo M-Cinco		23
1060541	1,57	6.150	Marco Puerta de Rebatir M-Cinco		24
1060542	2,55	6.030	Zócalo Reforzado Puerta de Rebatir M-Cinco		25
1060543	0,13	6.030	Guía Inferior Ventana y Puerta radio 3mm Corrediza M-Uno, M-Tres y M-Cinco		12
1060544	1,71	6.030	Travesaño Puerta de Rebatir M-Cinco		24
1060545	0,35	6.030	Contravidrio 26 mm. Puerta de Rebatir M-Cinco		24
1060546	0,35	6.030	Contravidrio 13 mm. Puerta de Rebatir M-Cinco		25
1060547	1,66	6.150	Cabezal y Parante Hoja Puerta de Rebatir M-Cinco		24
1060554	1,48	6.150	Marco Perimetral Ventana y Puerta Corrediza M-Cinco		21
1060555	1,43	6.150	Hoja Perimetral Ventana y Puerta Corrediza M-Cinco		22

CODIGO	PESO (Kg/m.)	LARGO (mm.)	DESCRIPCION	FORMA	PAG.
1060556	0,46	6.150	Encuentro de Hoja Ventana y Puerta Corrediza M-Cinco		22
1060558	0,49	6.030	Guía Mosquitero Ventana y Puerta Corrediza M-Cinco		21
1060559	0,24	6.030	Contravidrio de 16 mm. para Perfil 1060555		22
1060561	0,09	6.030	Guía Inferior Ventana y Puerta Corrediza M-Uno, M-Tres y M-Cinco		12
1060562	0,19	6.030	Perfil de Fijación Inferior Marco-Premarco		30
1060563	0,85	6.030	Columna Curva a 135°		31
1060564	1,07	6.030	Columna Curva a 90°		31
1060565	0,13	6.030	Tapa Puerta Vaivén M-Cinco		23
1060566	0,21	6.030	Guía de Cierre Puerta Vaivén M-Cinco		23
1060567	1,77	6.150	Hoja Puerta Vaivén M-Cinco		23
1060568	0,56	6.030	Acople Recto		31
1060569	0,33	6.030	Encuentro 4 Hojas M-Tres y M-Cinco		16
1060572	1,83	6.150	Marco Ventana y Puerta Corrediza M-Cinco con guía mosquitero		21
1060574	0,38	6.030	Guía Mosquitero Ventana y Puerta M-Siete		26
1060577	0,49	6.150	Guía Postiza de Cortina (Común y Barrio)		29
1060580	1,54	6.150	Hoja Perimetral con Contravidrio Ventana y Puerta Corrediza M-Cinco		22
1060589	1,43	6.150	Hoja Perimetral Recta DVH Ventana y Puerta Corrediza M-Cinco		22
1060590	0,20	6.030	Encuentro de Cuatro Hojas Ventana y Puerta Corrediza M-Uno		13
1060595	0,58	6.030	Rótula Interior		31
1060596	0,50	6.030	Rótula Exterior		31
1060597	0,89	6.150	Marco Puerta Vaivén M-Cinco		23
1060599	1,15	6.030	Tapa Inercial Ventana y Puerta M-Siete		27
1060600	0,80	6.030	Base Inercial Ventana y Puerta Corrediza M-Siete		27

CODIGO	PESO (Kg/m.)	LARGO (mm.)	DESCRIPCION	FORMA	PAG.
1060601	2,35	6.150	Marco Ventana y Puerta Corrediza M-Siete		26
1060602	2,33	6.150	Hoja Ventana y Puerta Corrediza M-Siete		26
1060603	1,30	6.150	Marco Postizo Ventana y Puerta Corrediza M-Siete		27
1060607	0,62	6.030	Encuentro de Cuatro Hojas Ventana y Puerta Corrediza M-Siete		27
1060608	0,26	6.030	Sobre Guía Marco Ventana y Puerta Corrediza M-Siete		26
1060609	0,66	6.150	Encuentro de Hoja para Perfil 602 Ventana y Puerta Corrediza M-Siete		26
1060611	0,30	6.030	Contravidrio Interno de 7 mm. Puerta de Rebatir y Vaivén M-Cinco		25
1060612	0,31	6.030	Contravidrio Interno de 21mm. Puerta de Rebatir y Vaivén M-Cinco		25
1020638	0,73	6.030	Travesaño Hoja Ventana y Puerta Corrediza M-Uno		12
1060647	0,46	6.150	Premarco de 48 mm.		30
1060648	0,50	6.150	Premarco de 55 mm.		30
1020681	0,70	6.030	Travesaño Hoja Ventana y Puerta Corrediza M-Uno		13
1060683	0,60	6.150	Tapacinta Cortina Común y Barrio		29
1060697	1,20	6.150	Marco Perimetral Ventana y Puerta Corrediza M-Tres		14
1060698	0,20	6.030	Contravidrio Curvo de 24 m.		28
1060699	0,13	6.030	Contravidrio Curvo de 3 mm.		28
1060705	0,16	6.030	Contravidrio Curvo 11 mm.		28
1060713	0,41	6.030	Encuentro de Hoja Ventana y Puerta Corrediza M-Tres		15
1060725	0,26	6.030	Tope Inferior Umbral Puerta de Rebatir M-Tres y M-Cinco		24
1060726	0,39	6.030	Umbral Transitable Puerta de Rebatir M-Tres y M-Cinco		24
1060727	0,26	6.030	Embellecedor de Marco		30
1060730	0,80	6.030	Travesaño de Hoja 1060787 Ventana y Puerta Corrediza M-Uno		11
1060738	0,80	6.030	Hoja Mosquitero Reforzado		27

CODIGO	PESO (Kg/m.)	LARGO (mm.)	DESCRIPCION	FORMA	PAG.
1060739	0,13	6.030	Tapa Mosquitero Reforzado		27
1060742	0,76	6.030	Hoja Perimetral D.V.H. Ventana y Puerta Corrediza M-Uno		11
1060743	0,30	6.030	Encuentro de Hoja Ventana y Puerta Corrediza M-Uno		11
1060785	0,82	6.030	Marco Ventana Desplazable M-Tres		19
1060786	1,18	6.030	Hoja Ventana Desplazable M-Tres		19
1060787	0,76	6.030	Hoja Perimetral V. Laminado Ventana y Puerta Corrediza M-Uno		11
1060802	1,09	6.030	Marco Perimetral Ventana y Puerta Corrediza M-Uno		11
1060815	0,59	6.030	Cabezal / Zócalo D.V.H. Ventana y Puerta Corrediza M-Uno		13
1060816	0,57	6.150	Parante Central D.V.H. Ventana y Puerta Corrediza M-Uno		13
1060817	0,85	6.150	Parante Central Reforzado D.V.H. Ventana y Puerta Corrediza M-Uno		13
1060818	1,08	6.030	Zócalo Alto D.V.H. Ventana y Puerta Corrediza M-Uno		13
1060819	0,61	6.150	Parante Lateral D.V.H. Ventana y Puerta Corrediza M-Uno		13
1060820	0,62	6.030	Cabezal / Zócalo V.S. Ventana y Puerta Corrediza M-Uno		12
1060822	0,60	6.150	Parante Central V.S. Ventana y Puerta Corrediza M-Uno		12
1060823	0,64	6.150	Parante Lateral V.S. Ventana y Puerta Corrediza M-Uno		12
1060824	1,11	6.030	Zócalo Alto V.S. Ventana y Puerta Corrediza M-Uno		12
1060825	0,84	6.150	Inversor de Hoja Ventana y Puerta de Rebatir M-Tres		18
1060826	1,05	6.150	Hoja D.V.H. Sin Contravidrios M-Tres		17
1060827	1,09	6.150	Hoja V.S. Sin Contravidrios M-Tres		17
1060834	0,88	6.150	Parante Central Reforzado V.S. Ventana y Puerta Corrediza M-Uno		12
1060835	0,94	6.030	Travesaño Angosto Paño Fijo y Puerta de Rebatir M-Tres		19
1060843	0,34	6.150	Bisagra Tapacinta		29
1060849	1,54	6.030	Zócalo Puerta de Rebatir M-Tres		18

CODIGO	PESO (Kg/m.)	LARGO (mm.)	DESCRIPCION	FORMA	PAG.
1060850	1,55	6.030	Acople Recto Reforzado		32
1060852	1,20	6.150	Hoja Corrediza M-Tres Recta VS		16
1060853	1,15	6.150	Hoja Corrediza M-Tres Recta DVH		16
1060854	1,60	6.030	Acople Recto Reforzado		32
1060855	1,59	6.030	Acople Recto Reforzado		32
1060857	0,27	6.150	Contramarco de 65 mm.		30
1060859	0,57	6.030	Soporte Exterior de Vidrio Paño Fijo M-Cinco		23
1060860	1,19	6.030	Marco Paño Fijo M-Cinco		23
1060861	1,10	6.150	Cabezal y Parante de Hoja Puerta de Rebatir M-Tres		18
1060862	0,21	6.150	Contramarco de 45 mm.		30
1060870	0,23	6.030	Contravidrio Curvo de 31 mm.		28
1060873	2,10	6.150	Marco Perimetral de Tres Guías Ventana y Puerta Corrediza M-Tres		14
1060874	2,30	6.150	Marco Perimetral de Tres Guías Ventana y Puerta Corrediza M-Cinco		21
1060875	0,88	6.150	Premarco para Marcos de Tres Guías Ventana y Puerta Corrediza		30
1060876	0,33	6.030	Contravidrio Recto de 29 mm.		28
1060877	0,30	6.030	Contravidrio Recto de 22 mm.		28
1060878	0,25	6.030	Contravidrio Recto de 15 mm.		28
1060880	0,32	6.030	Contravidrio Recto de 25 mm.		28
1060881	1,19	6.150	Hoja Perimetral V.S. Ventana y Puerta Corrediza M-Tres		15
1060882	1,14	6.150	Hoja Perimetral D.V.H. Ventana y Puerta Corrediza M-Tres		15
1060883	0,90	6.150	Hoja Ventana de Rebatir, Banderola y Oscilo-Batiente M-Tres		17
1060884	0,20	6.150	Contramarco de 30 mm.		30
1060885	0,20	6.030	Contravidrio Recto de 9 mm.		28

CODIGO	PESO (Kg/m.)	LARGO (mm.)	DESCRIPCION	FORMA	PAG.
1060886	1,18	6.150	Hoja Perimetral con Contravidrio Ventana y Puerta Corrediza M-Tres		15
1060887	0,19	6.030	Contravidrio Recto de 6 mm		28
1060888	1,21	6.030	Travesaño Ancho Paño Fijo y Puerta de Rebatir M-Tres		19
1060889	1,30	6.150	Hoja Puerta de Rebatir M-Arq. C-16		20
1060890	1,12	6.150	Marco Ventana y Puerta de Rebatir M-Arq. C-16		20
1060891	1,08	6.150	Hoja Ventana de Rebatir M-Arq. C-16		20
1060892	0,82	6.150	Inversor de Hoja Ventana y Puerta de Rebatir M-Arq. C-16		20
1060893	1,08	6.150	Marco No-Coplanar Paño Fijo, V de Rebatir, Banderola, Oscilo-batiente y Puerta M-Tres		17
1060894	1,02	6.150	Marco Coplanar, V. de Rebatir, Banderola, Oscilo-Batiente, Puerta M-Tres		17
9469	-	6.150	Pletina de Poliamida		29

Tipologías Disponibles	M-Uno	M-Tres	M-Cinco	M-Siete
Paño Fijo		■	■	
Ventana de Rebatir		■		
Ventana de Rebatir C-16 Arq.		■		
Ventana Banderola		■		
Ventana Oscilo-Batiente		■		
Ventana Oscilo-Batiente C-16 Arq.		■		
Puerta de Rebatir		■	■	
Puerta Vaivén			■	
Ventana y Puerta Corrediza	■	■	■	■
Ventana y Puerta Corrediza-Elevable				■
Ventana Desplazable a Tijera		■		

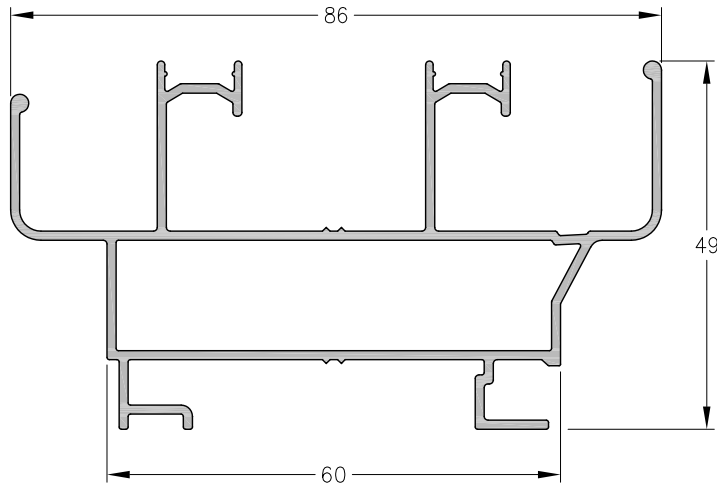

1060802 - Marco Perimetral
 Peso: 1,09 Kg/m.
 Largo Std.: 6.030 mm.

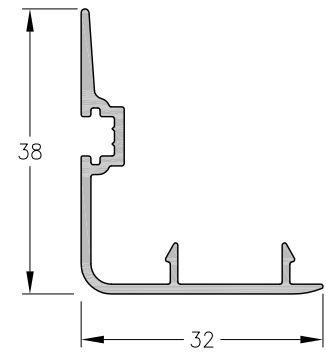

1060743 - Encuentro de hoja M-Uno
 Peso: 0.31 Kg/m.
 Largo Std.: 6.030 mm.

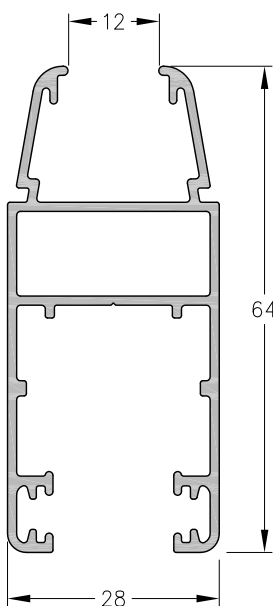

1060787 - Hoja Perimetral V. Laminado
 Peso: 0,76 Kg/m.
 Largo Std.: 6.030 mm.

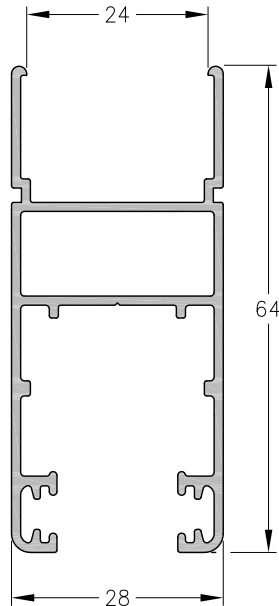

1060742 - Hoja Perimetral D.V.H.
 Peso: 0,72 Kg/m.
 Largo Std.: 6.030 mm.

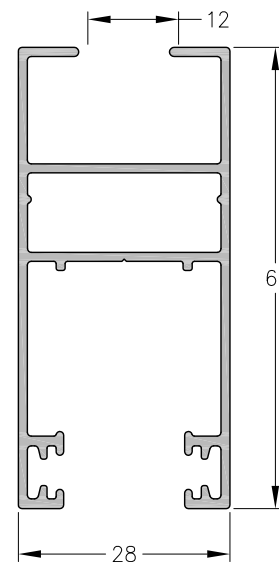

1060405 - Hoja corrediza VS
 Peso: 0,72 Kg/m
 Largo Std.: 6030 mm

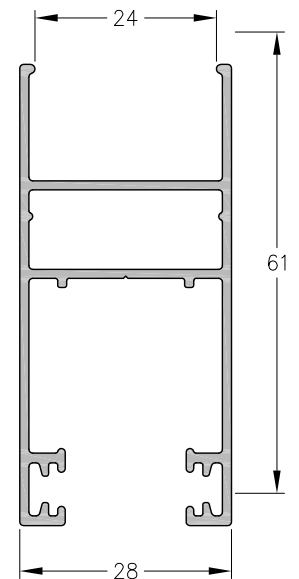

1060406 - Hoja corrediza DVH
 Peso: 0,68 Kg/m
 Largo Std.: 6030 mm

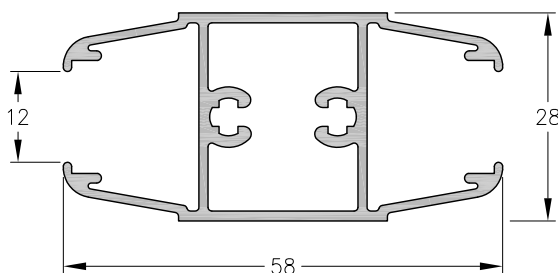

1060730 - Travesaño Hoja 1060787
 Peso: 0,80 Kg/m.
 Largo Std.: 6.030 mm.

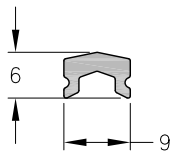

1060561 - Guía Inferior
 Peso: 0,09 Kg/m.
 Largo Std.: 6.030 mm.

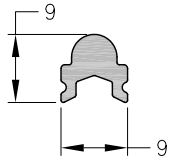

1060543 - Guía Inferior radio 3 mm
 Peso: 0,13 Kg/m
 Largo Std.: 6030 mm

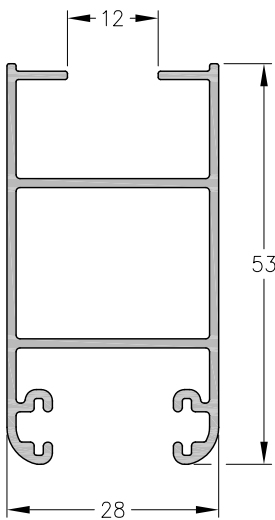

1060823 - Parante Lateral V.S.
 Peso: 0,64 Kg/m.
 Largo Std.: 6.150 mm.

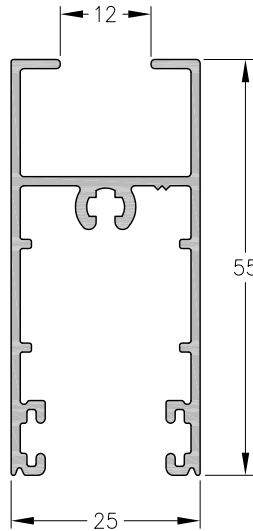

1060820 - Cabezal / Zócalo V.S.
 Peso: 0,62 Kg/m.
 Largo Std.: 6.030 mm.

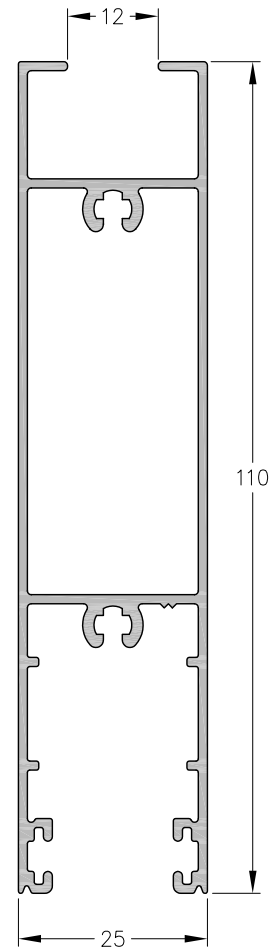

1060824 - Zócalo Alto V.S.
 Peso: 1,11 Kg/m.
 Largo Std.: 6.030 mm.

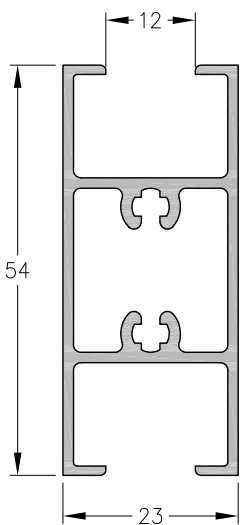

1020638 - Travesaño para
 hoja N-Uno
 Peso: 0,73 Kg/m
 Largo Std.: 6030 mm

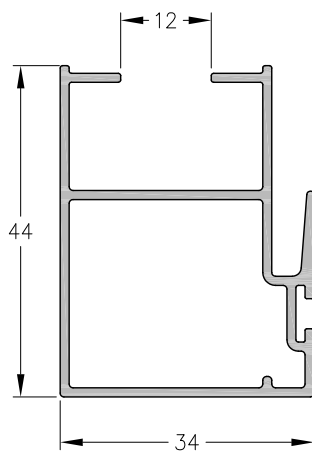

1060822 - Parante Central
 V.S.
 Peso: 0,60 Kg/m.
 Largo Std.: 6.150 mm.

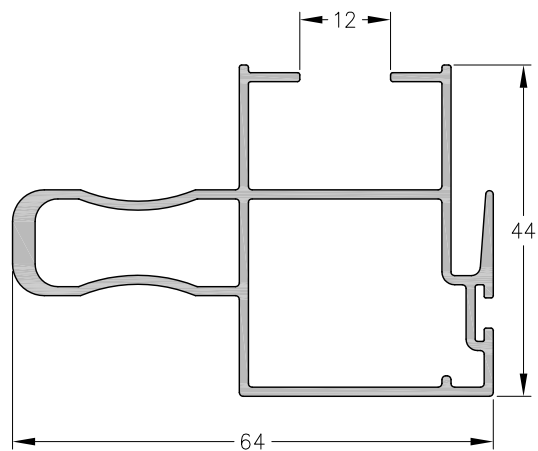

1060834 - Parante Central Ref.
 V.S.
 Peso: 0,88 Kg/m.
 Largo Std.: 6.150 mm.

Escala 1:1

Tolerancia en Peso +/- 10%

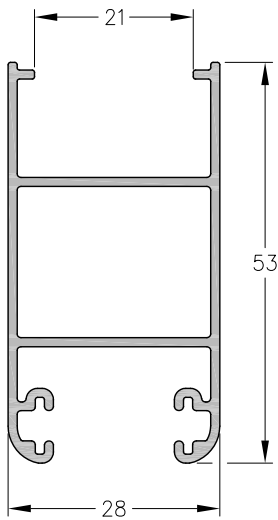

1060819 - Parante Lateral D.V.H.
 Peso: 0,61 Kg/m.
 Largo Std.: 6.150 mm.

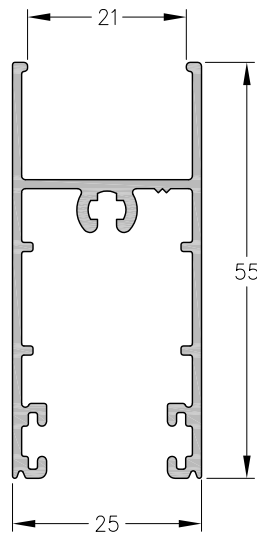

1060815 - Cabezal / Zócalo D.V.H.
 Peso: 0,59 Kg/m.
 Largo Std.: 6.030 mm.

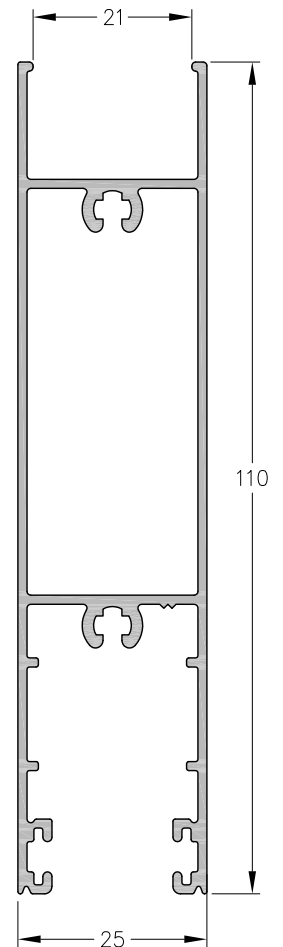

1060818 - Zócalo Alto D.V.H.
 Peso: 1,08 Kg/m.
 Largo Std.: 6.030 mm.

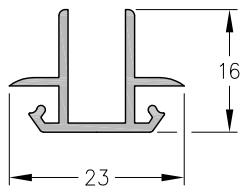

**1060590 - Encuentro
 Cuatro Hojas M-Uno**
 Peso: 0,20 Kg/m.
 Largo Std.: 6.030 mm.

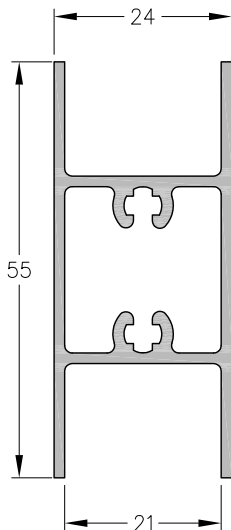

**1020681 - Travesaño para
 hoja N-Uno**
 Peso: 0,70 Kg/m.
 Largo Std.: 6.030 mm.

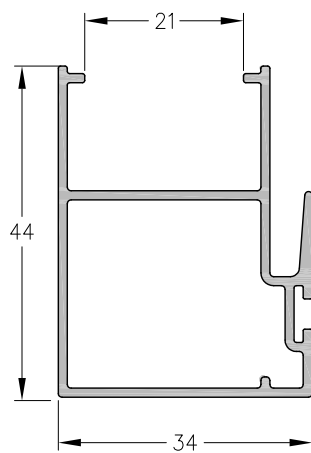

**1060816 - Parante Central
 D.V.H.**
 Peso: 0,57 Kg/m.
 Largo Std.: 6.150 mm.

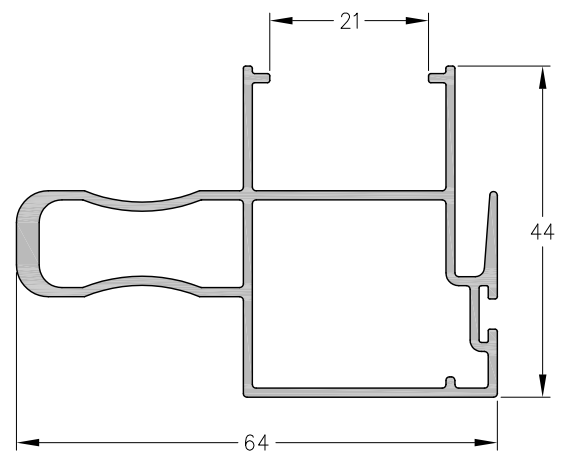

**1060817 - Parante Central Ref.
 D.V.H.**
 Peso: 0,85 Kg/m.
 Largo Std.: 6.150 mm.

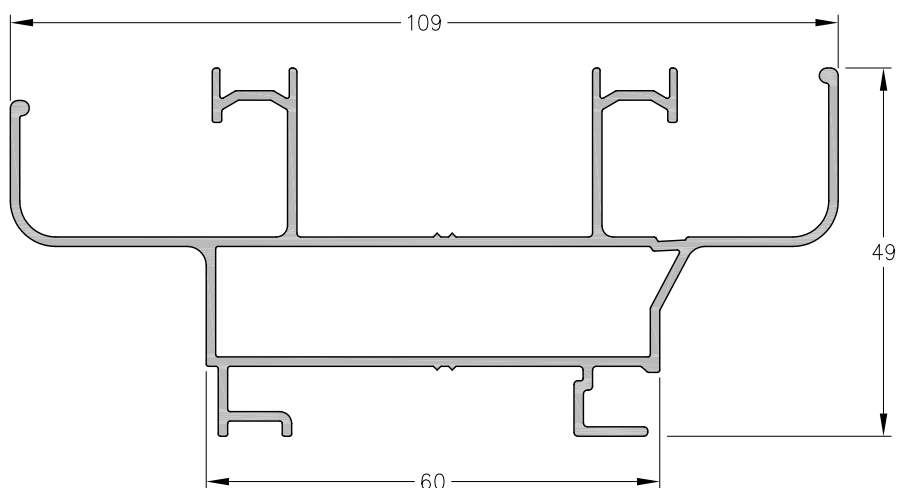

1060697 - Marco Perimetral
Peso: 1,20 Kg/m.
Largo Std.: 6.150 mm.

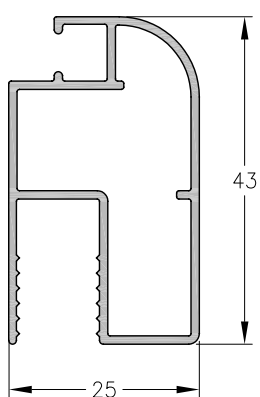

1060108 - Hoja Mosquitero
Peso: 0,47 Kg/m.
Largo Std.: 6.030 mm.

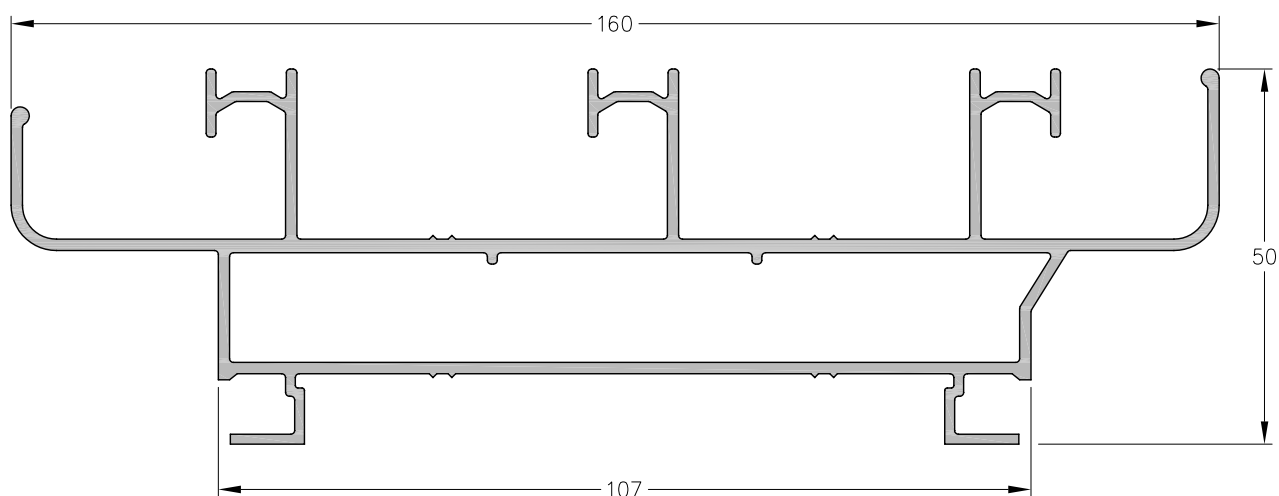

1060873 - Marco Perimetral de Tres Guías
Peso: 2,10 Kg/m.
Largo Std.: 6.150 mm.

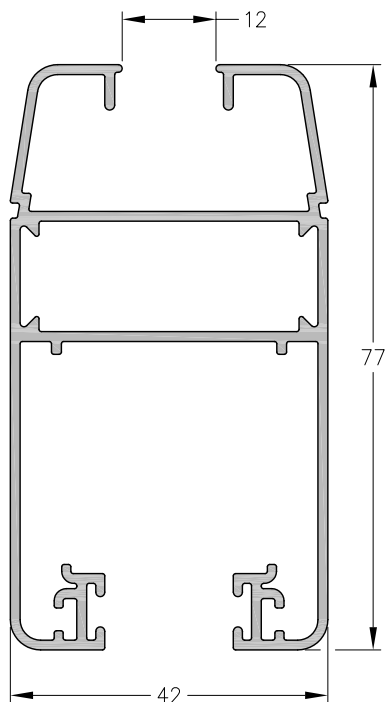

1060881 - Hoja Perimetral V.S.
Peso: 1,19 Kg/m.
Largo Std.: 6.150 mm.

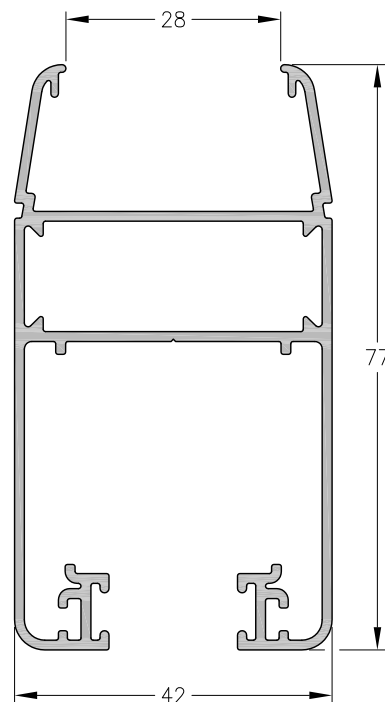

1060882 - Hoja Perimetral D.V.H.
Peso: 1,12 Kg/m.
Largo Std.: 6.150 mm.

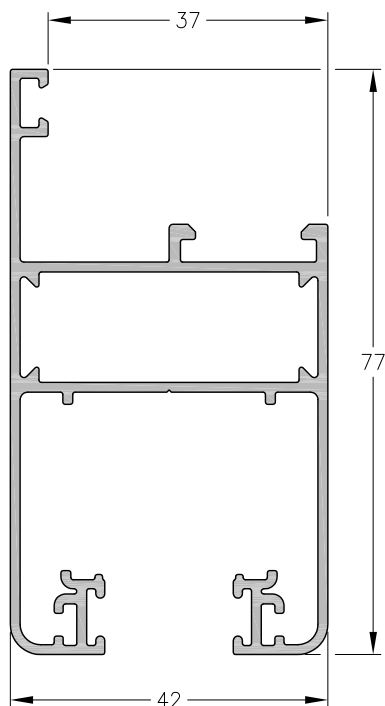

1060886 - Hoja Perimetral
con Contravidrio
Peso: 1,08 Kg/m.
Largo Std.: 6.150 mm.

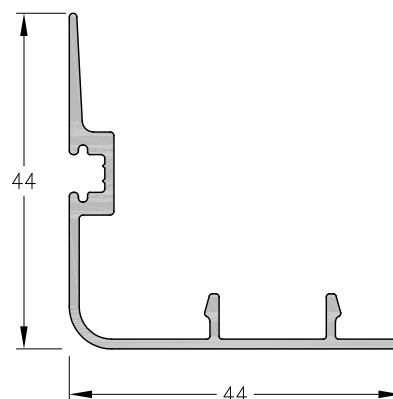

1060713 - Encuentro Corrediza M-Tres
Peso: 0,413 Kg/m.
Largo Std.: 6030 mm.

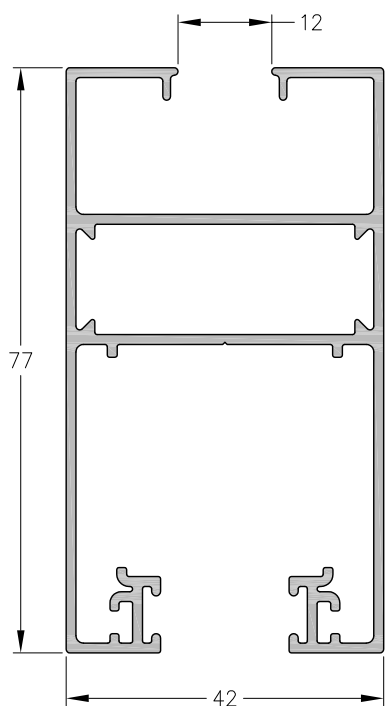

1060852 - Hoja Corrediza M-Tres recta VS
Peso: 1,20 Kg/m
Largo Std.: 6150 mm

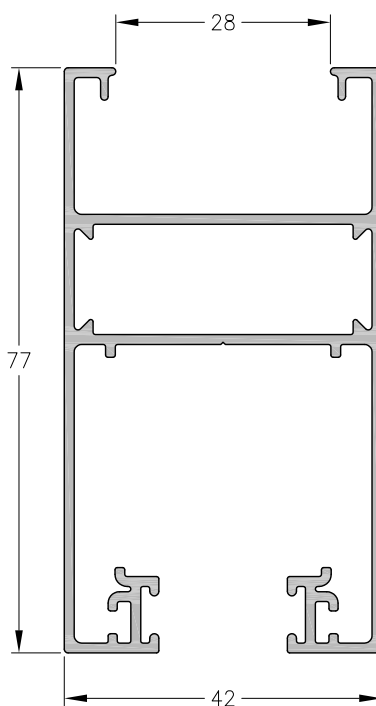

1060853 - Hoja Corrediza M-Tres recta DVH
Peso: 1,15 Kg/m
Largo Std.: 6150 mm

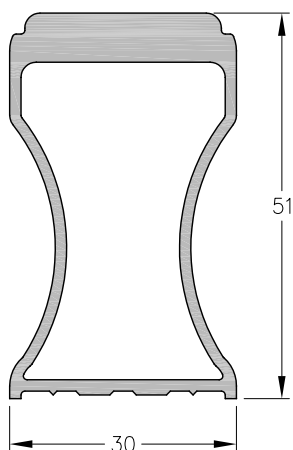

1060518 - Refuerzo Parantes
M-Uno, M-Tres y M-Cinco
Peso: 1,00 Kg/m.
Largo Std.: 6.030 mm.

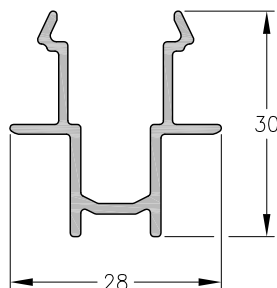

1060569 - Encuentro Cuatro
Hojas M-Tres y M-Cinco
Peso: 0,33 Kg/m.
Largo Std.: 6.030 mm.

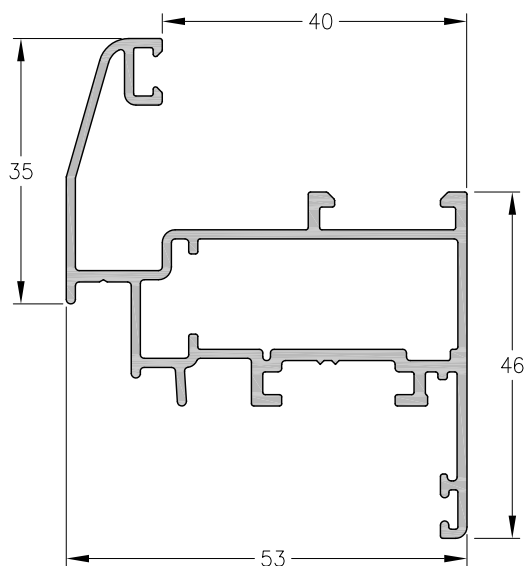
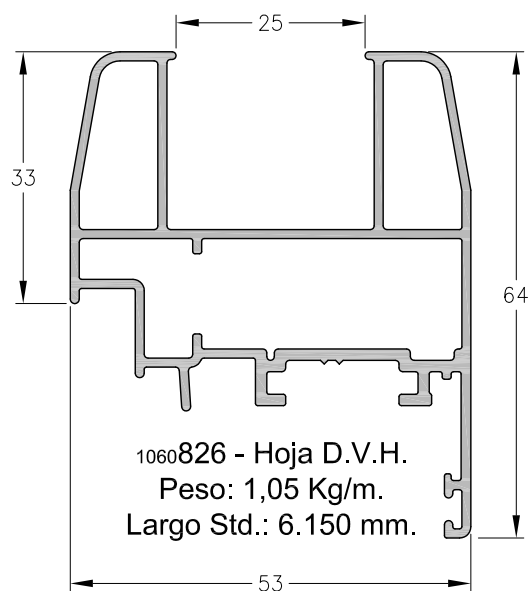
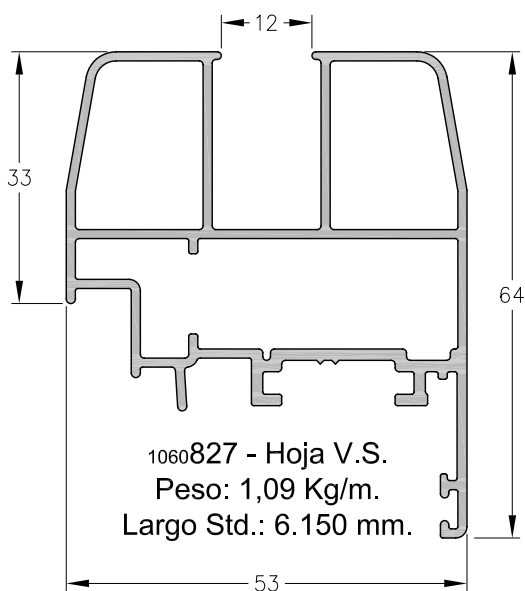
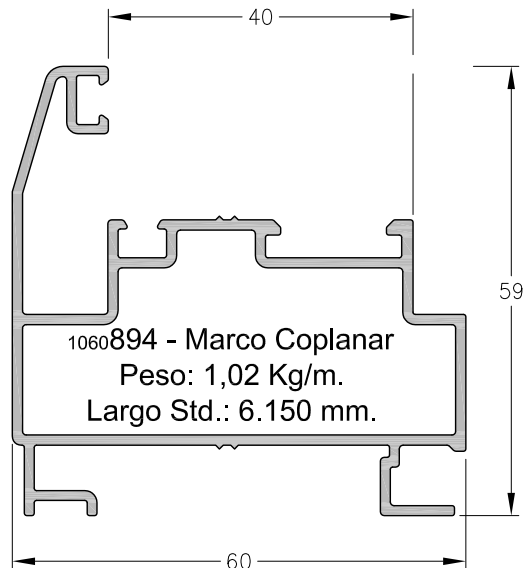
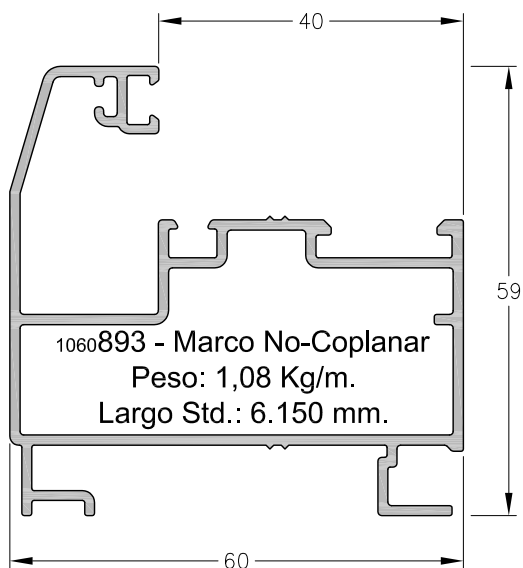

Escala 1:1
Tolerancia en Peso +/- 10%

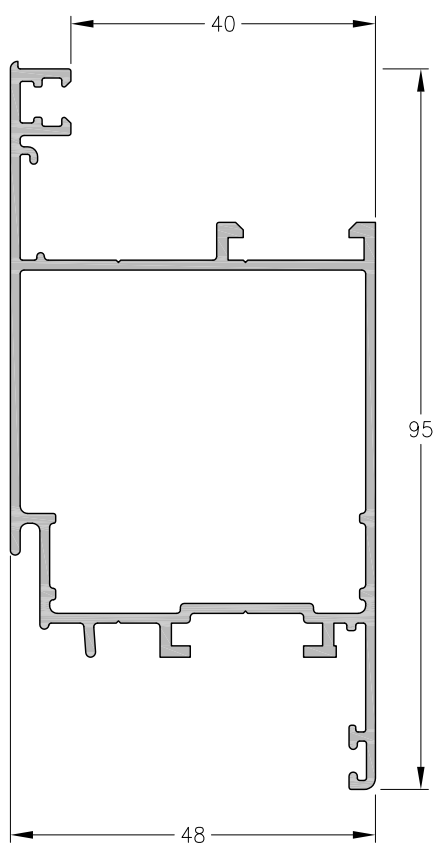

1060861 - Cabezal y Parante
Peso: 1,10 Kg/m.
Largo Std.: 6.150 mm.

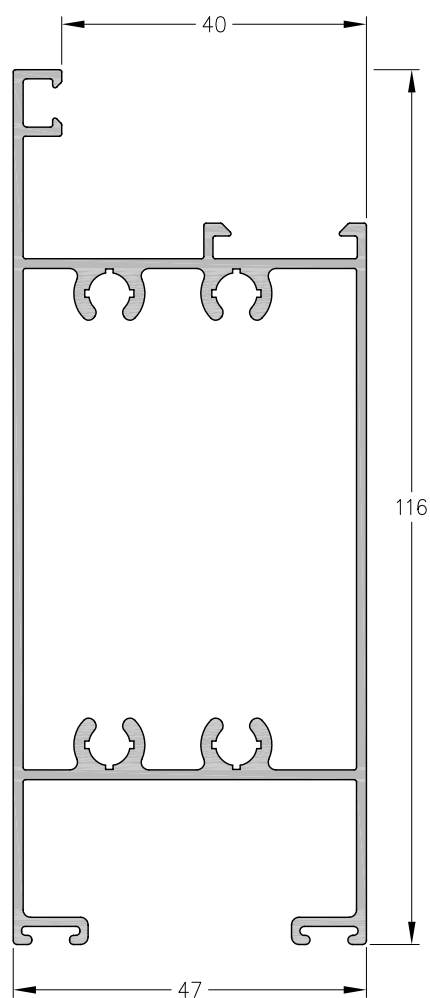

1060849 - Zócalo
Peso: 1,54 Kg/m.
Largo Std.: 6.030 mm.

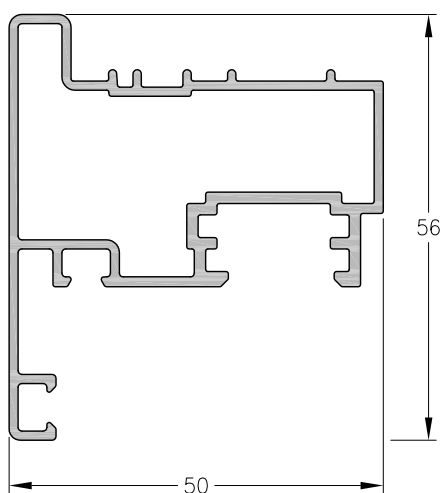

1060825 - Inversor
Peso: 0,84 Kg/m.
Largo Std.: 6.150 mm.

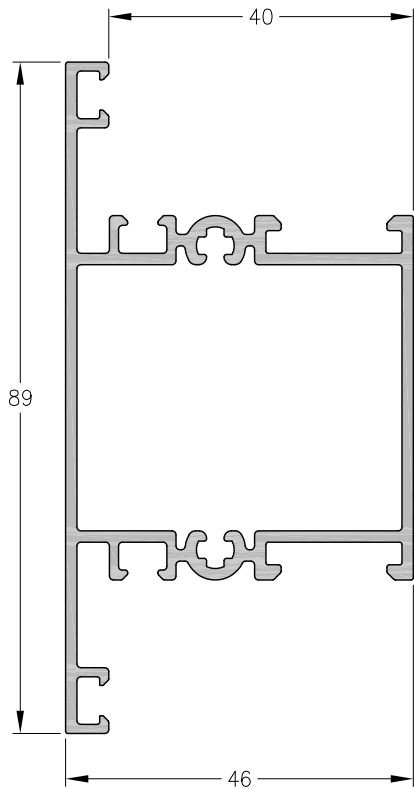

1060888 - Travesañó Ancho
Peso: 1,21 Kg/m.
Largo Std.: 6.030 mm.

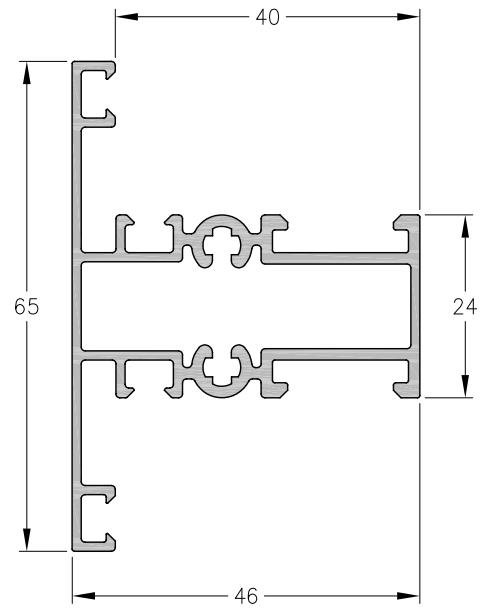

1060835 - Travesañó Angosto
Peso: 0,94 Kg/m.
Largo Std.: 6.030 mm.

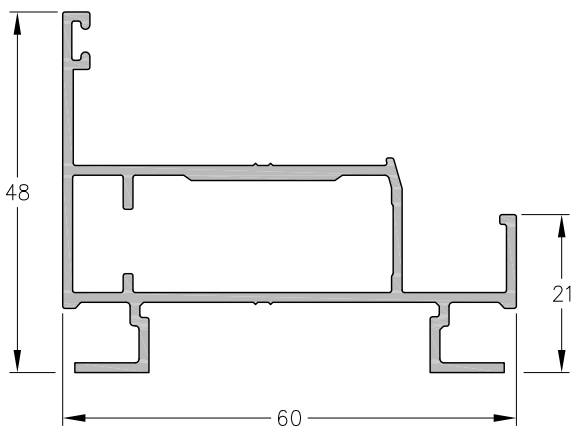

1060785 - Marco Ventana Desplazable
Peso: 0,82 Kg/m.
Largo Std.: 6.030 mm.

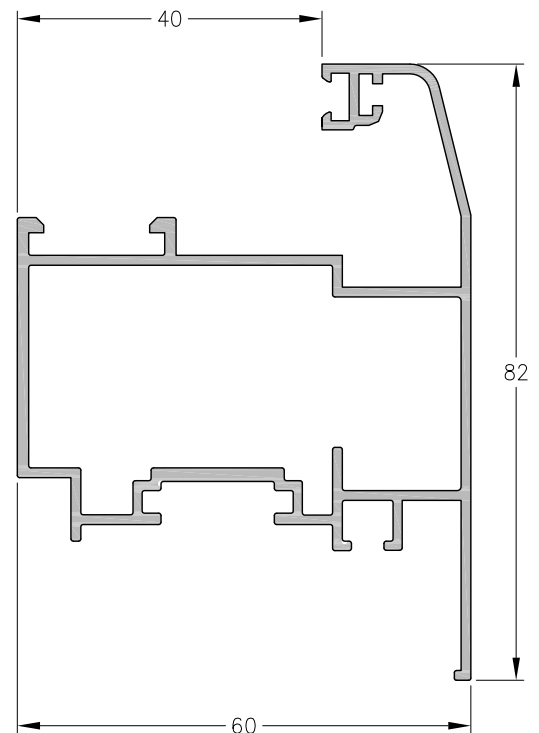

1060786 - Hoja Ventana Desplazable
Peso: 1,18 Kg/m.
Largo Std.: 6.030 mm.

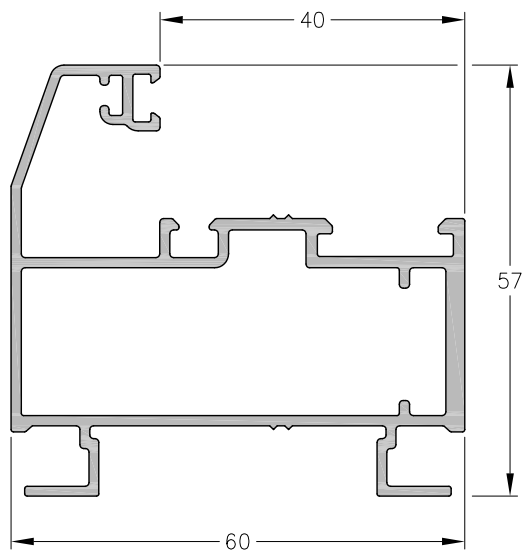

1060890 - Marco C-16
Peso: 1,12 Kg/m.
Largo Std.: 6.150 mm.

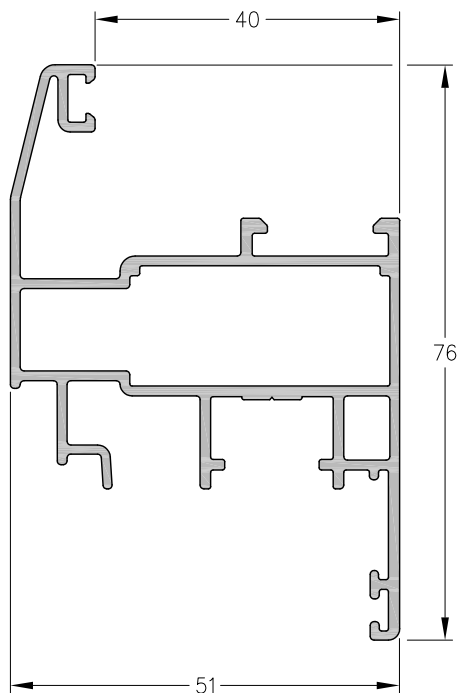

1060891 - Hoja C-16
Peso: 1,08 Kg/m.
Largo Std.: 6.150 mm.

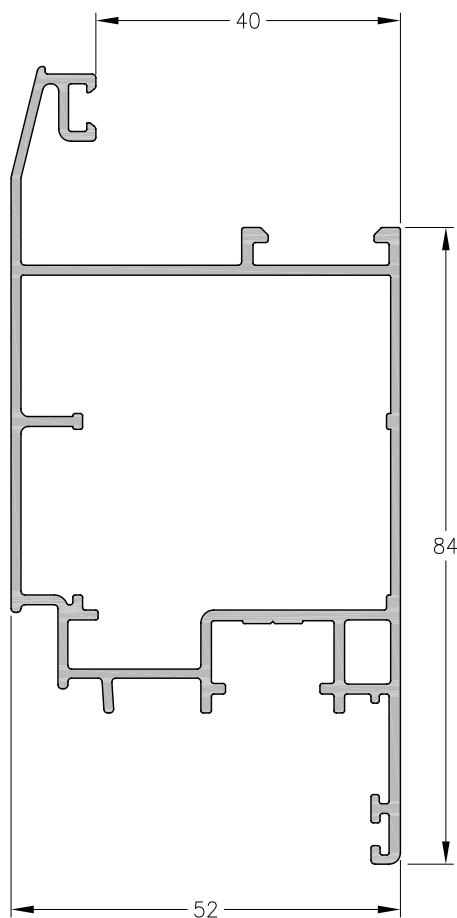

1060889 - Hoja C-16
Peso: 1,30 Kg/m.
Largo Std.: 6.150 mm.

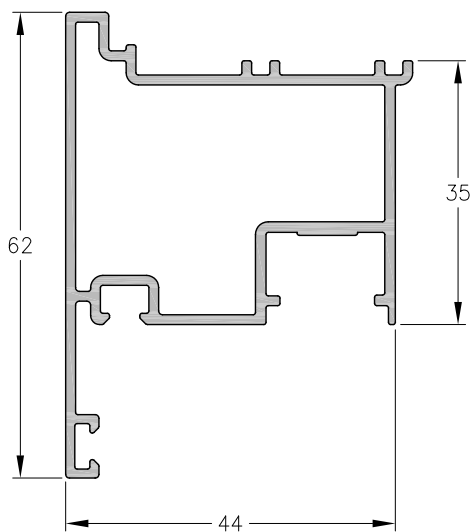

1060892 - Inversor C-16
Peso: 0,82 Kg/m.
Largo Std.: 6.150 mm.

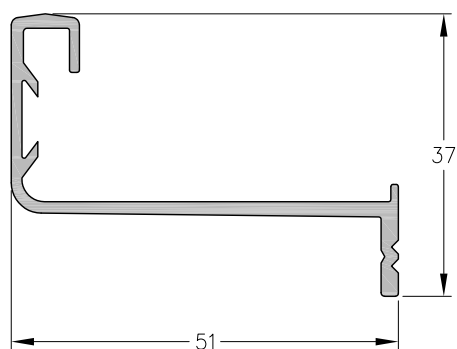

1060558 - Guía Mosquitero
Peso: 0,49 Kg/m.
Largo Std.: 6.030 mm.

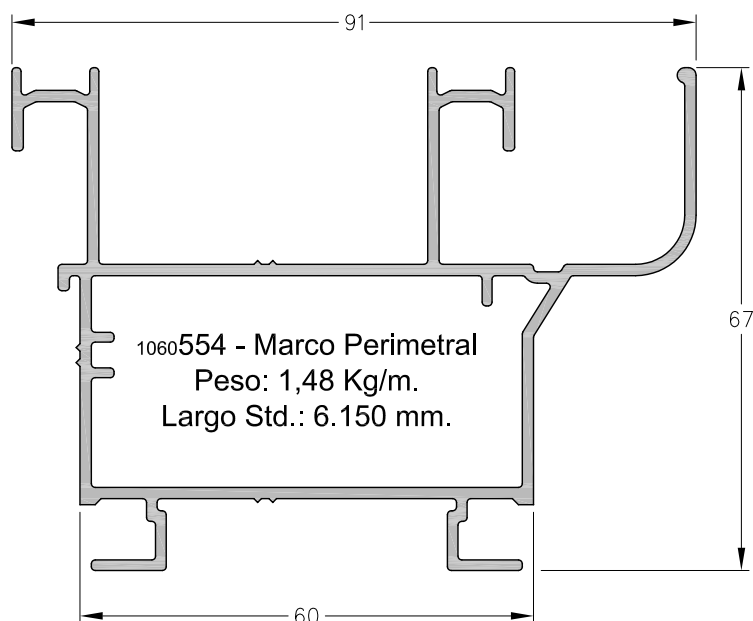

1060554 - Marco Perimetral
Peso: 1,48 Kg/m.
Largo Std.: 6.150 mm.

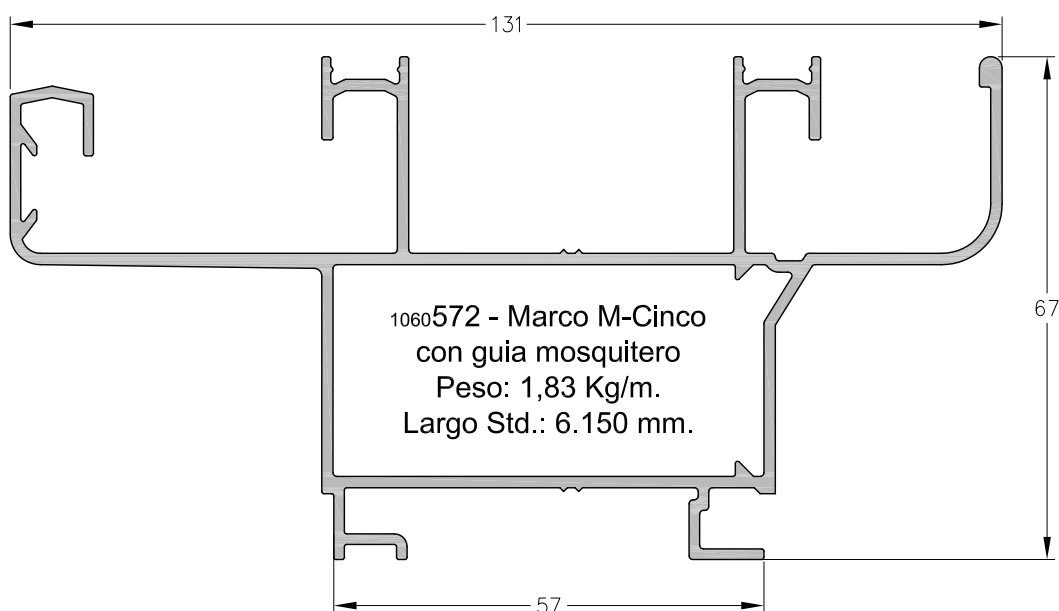

**1060572 - Marco M-Cinco
con guía mosquitero**
Peso: 1,83 Kg/m.
Largo Std.: 6.150 mm.

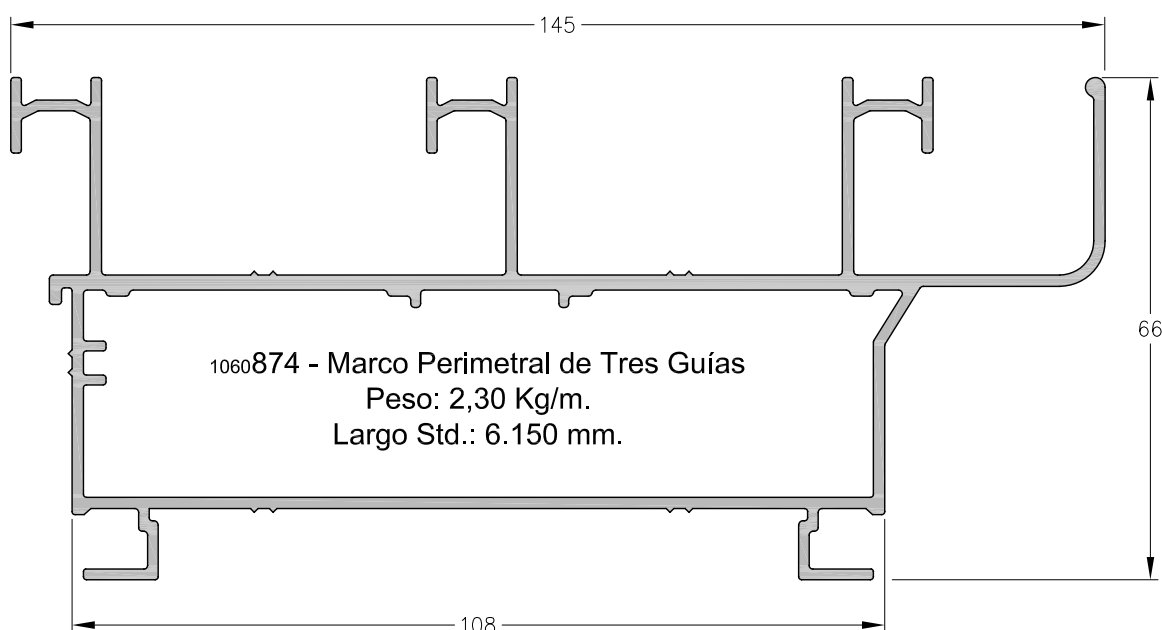

1060874 - Marco Perimetral de Tres Guías
Peso: 2,30 Kg/m.
Largo Std.: 6.150 mm.

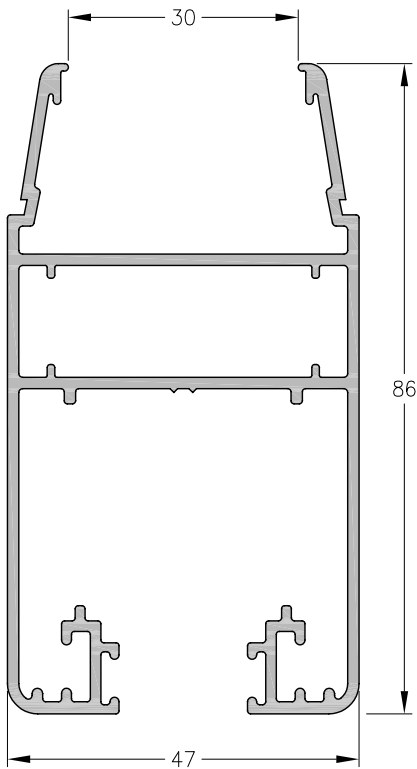

1060555 - Hoja Perimetral
Peso: 1,43 Kg/m.
Largo Std.: 6.150 mm.

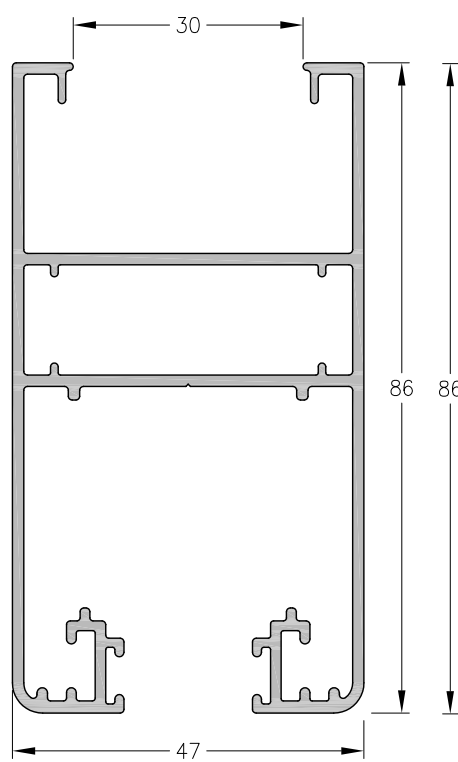

1060589 - Hoja recta DVH M-Cinco
Peso: 1.43 Kg/m.
Largo Std.: 6150 mm.

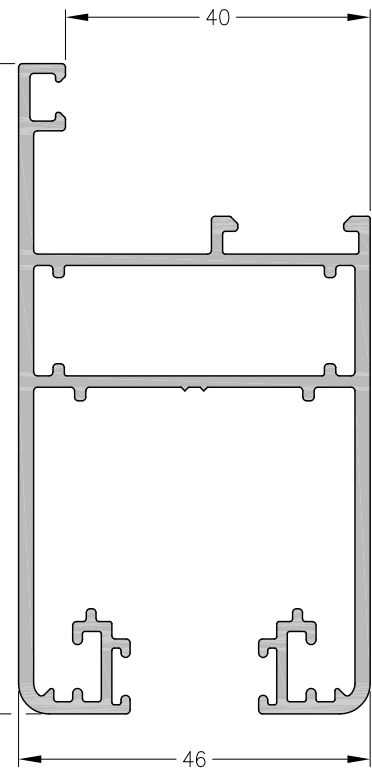

1060580 - Hoja Perimetral con Contravidrio
Peso: 1,54 Kg/m.
Largo Std.: 6.150 mm.

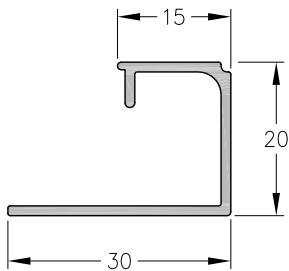

1060559 - Contravidrio 16 mm.
para Perfil 1060555
Peso: 0,24 Kg/m.
Largo Std.: 6.030 mm.

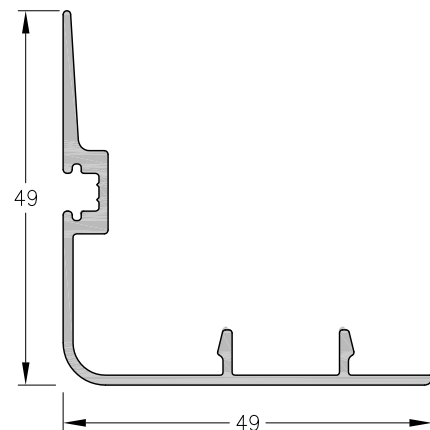

1060556 - Encuentro de hoja M-Cinco
Peso: 0.46 Kg/m.
Largo Std.: 6150 mm.

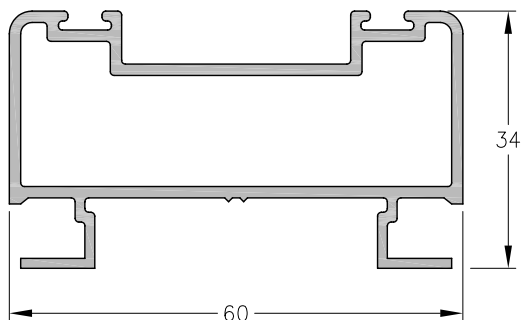

1060597 - Marco Puerta Vaivén
Peso: 0,89 Kg/m.
Largo Std.: 6.150 mm.

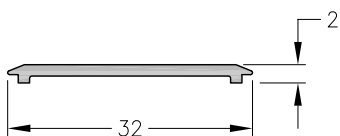

1060565 - Tapa Puerta Vaivén
Peso: 0,13 Kg/m.
Largo Std.: 6.030 mm.

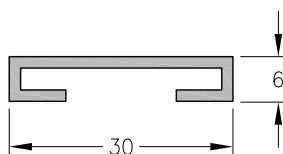

1060566 - Guía de Cierre Puerta Vaivén
Peso: 0,21 Kg/m.
Largo Std.: 6.030 mm.

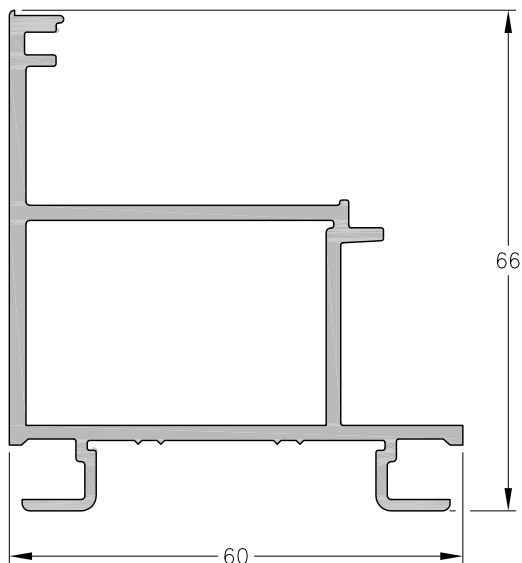

1060860 - Marco Paño Fijo
Peso: 1,19 Kg/m.
Largo Std.: 6.030 mm.

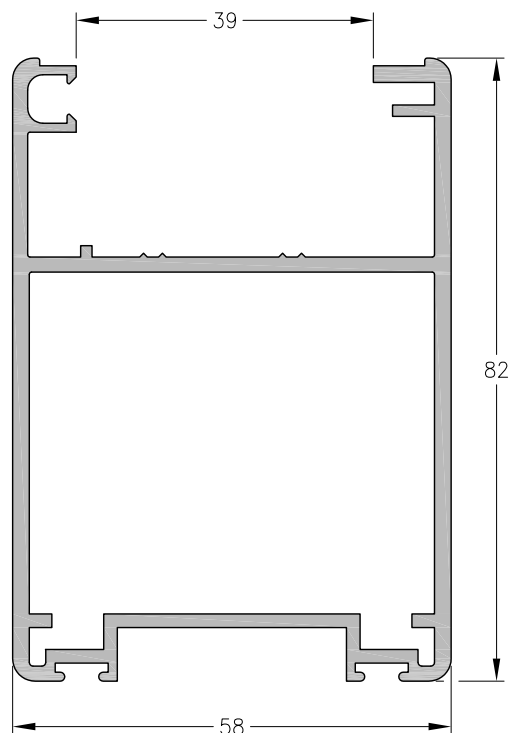

1060567 - Hoja Puerta Vaivén
Peso: 1,77 Kg/m.
Largo Std.: 6.150 mm.

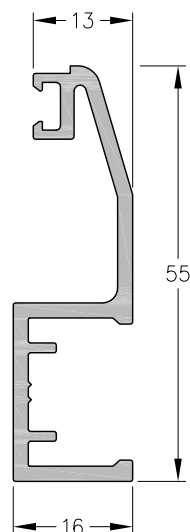

1060859 - Soporte Vidrio Paño Fijo
Peso: 0,57 Kg/m.
Largo Std.: 6.030 mm.

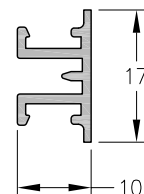

1060540 - Tapa Soporte Paño Fijo
Peso: 0,15 Kg/m.
Largo Std.: 6.030 mm.

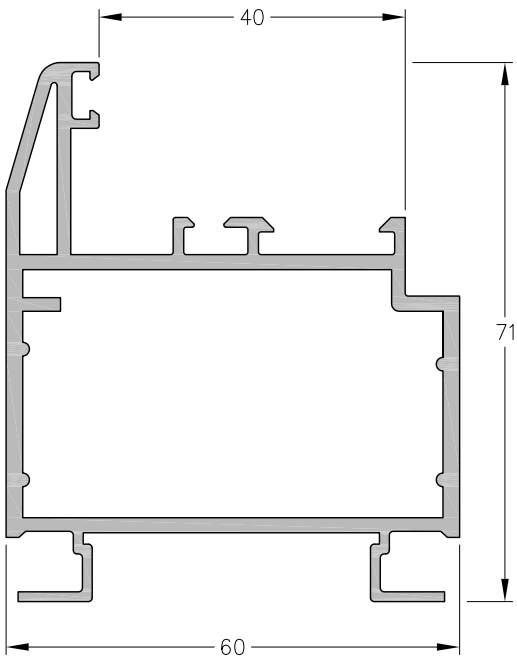

1060541 - Marco
Peso: 1,57 Kg/m.
Largo Std.: 6.150 mm.

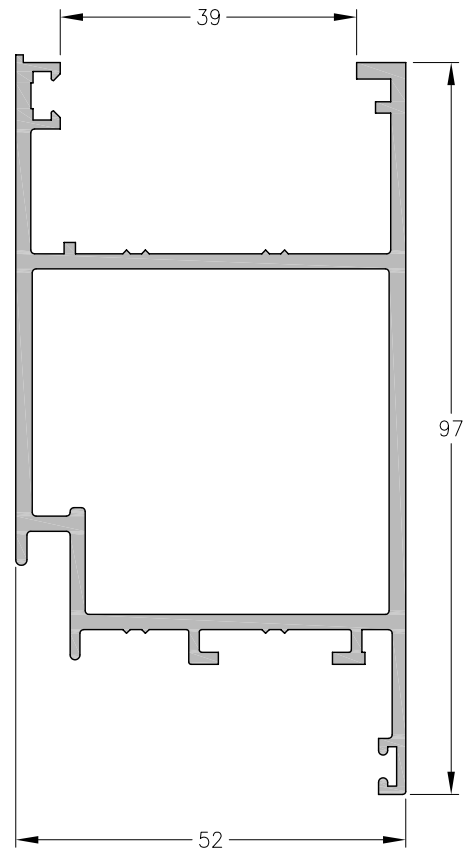

1060547 - Cabezal y Parante de Hoja
Peso: 1,66 Kg/m.
Largo Std.: 6.150 mm.

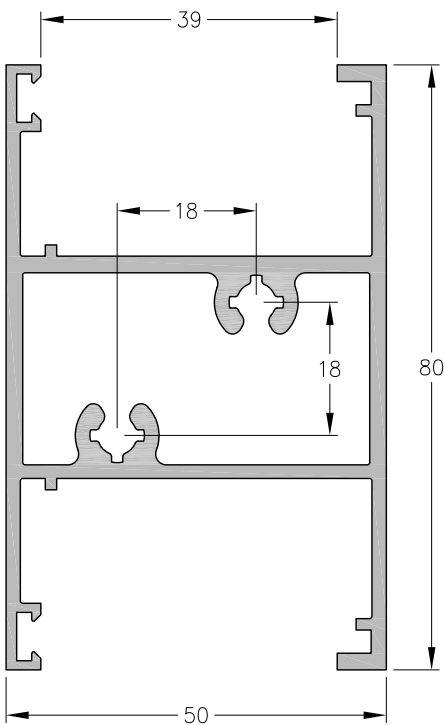

1060544 - Travesaño
Peso: 1,71 Kg/m.
Largo Std.: 6.030 mm.

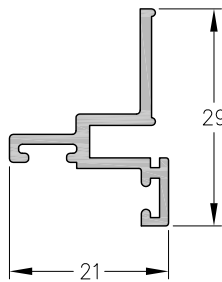

1060725 - Tope Inferior Umbral
Peso: 0,26 Kg/m.
Largo Std.: 6.030 mm.

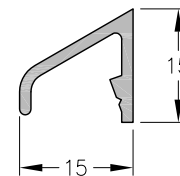

1060200 - Bota-Agua
Peso: 0,15 Kg/m.
Largo Std.: 6.030 mm.

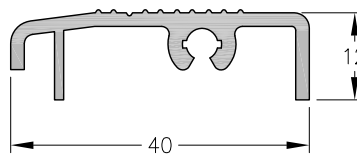

1060726 - Umbral Transitable
Peso: 0,39 Kg/m.
Largo Std.: 6.030 mm.

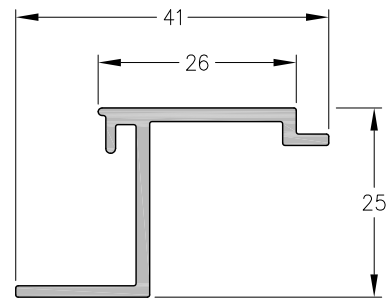

1060545 - Contravidrio de 26 mm.
Peso: 0,35 Kg/m.
Largo Std.: 6.030 mm.

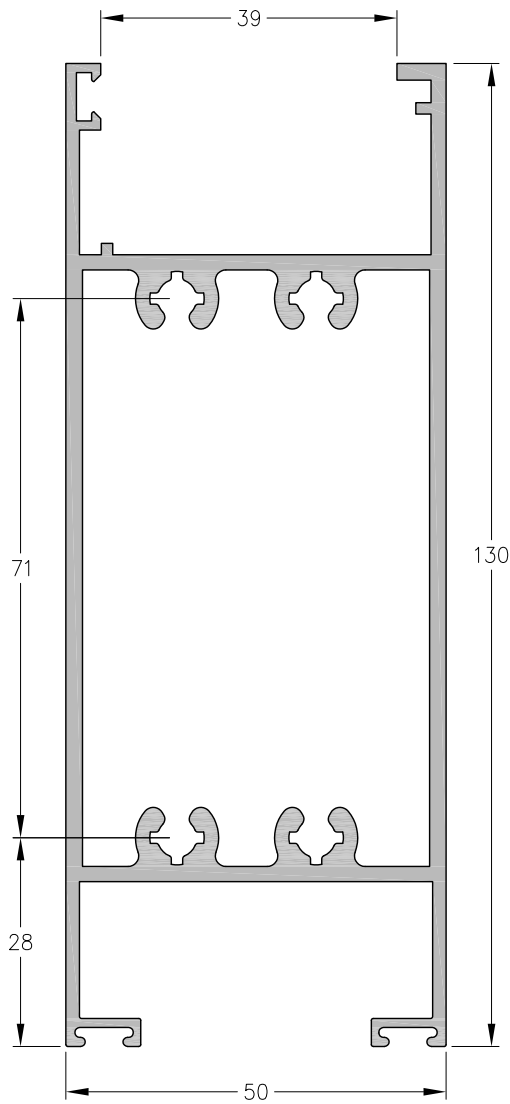

1060542 - Zócalo Reforzado
Peso: 2,55 Kg/m.
Largo Std.: 6.030 mm.

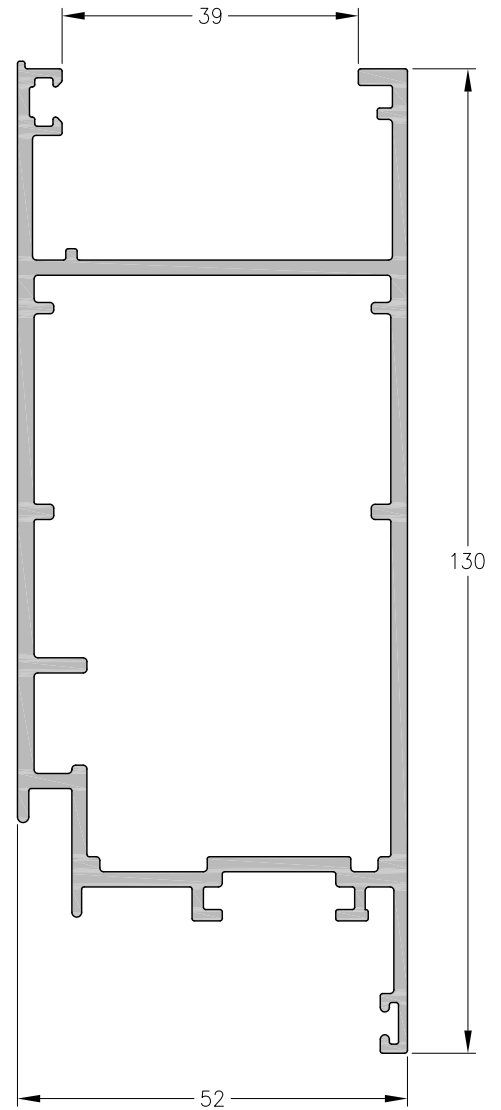

1060500 - Cabezal y Parante Reforzado
Peso: 2,17 Kg/m.
Largo Std.: 6.150 mm.

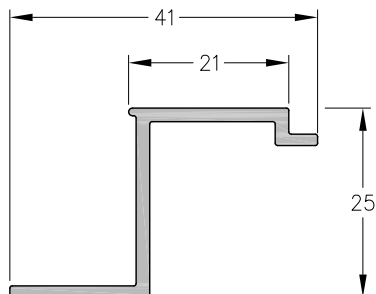

1060612 - Contravidrio
de 21,2 mm.
Peso: 0,31 Kg/m.
Largo Std.: 6.030 mm.

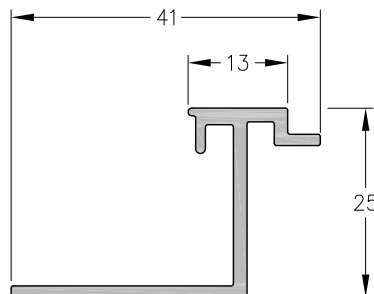

1060546 - Contravidrio
de 13,2 mm.
Peso: 0,35 Kg/m.
Largo Std.: 6.030 mm.

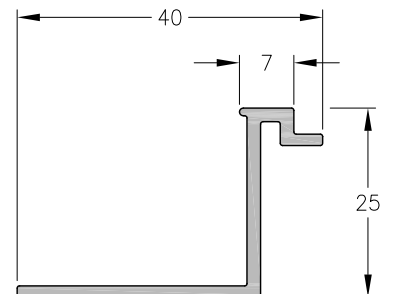

1060611 - Contravidrio
de 7,2 mm.
Peso: 0,30 Kg/m.
Largo Std.: 6.030 mm.

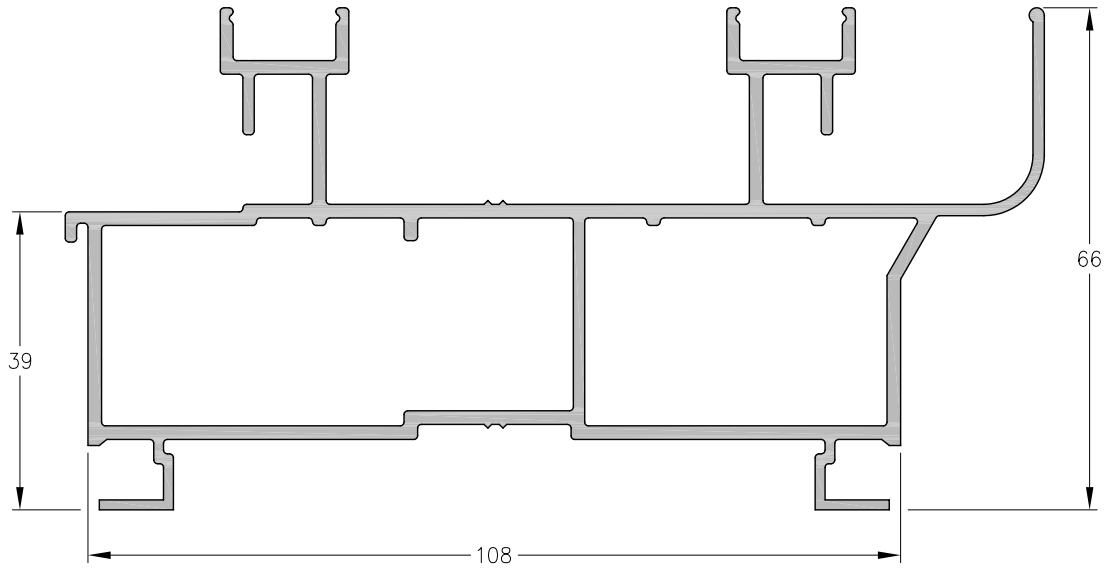

1060601 - Marco
Peso: 2,35 Kg/m.
Largo Std.: 6.150 mm.

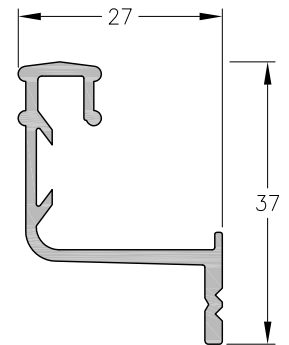

1060574 - Guía Mosquitero
Peso: 0,38 Kg/m.
Largo Std.: 6.030 mm.

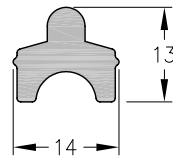

1060608 - Sobre Guía Marco
Peso: 0,26 Kg/m.
Largo Std.: 6.030 mm.

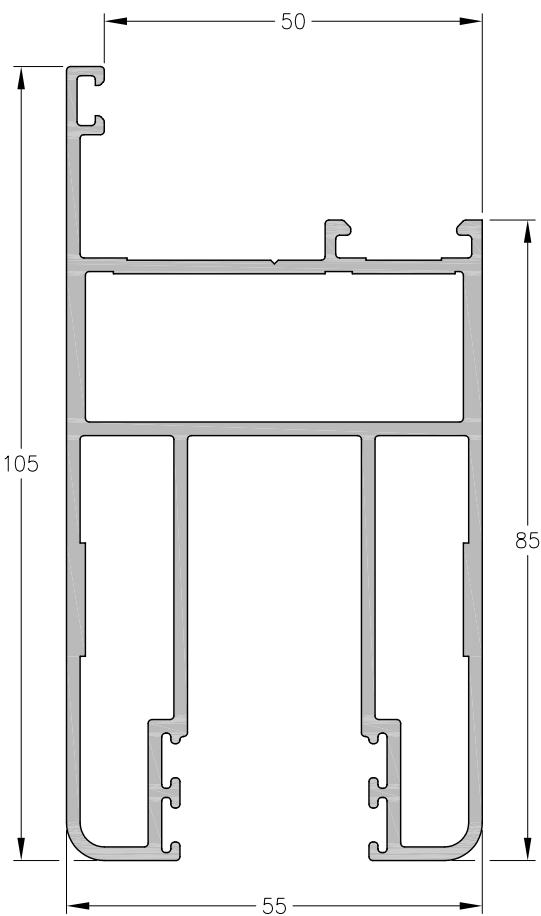

1060602 - Hoja
Peso: 2,33 Kg/m.
Largo Std.: 6.150 mm.

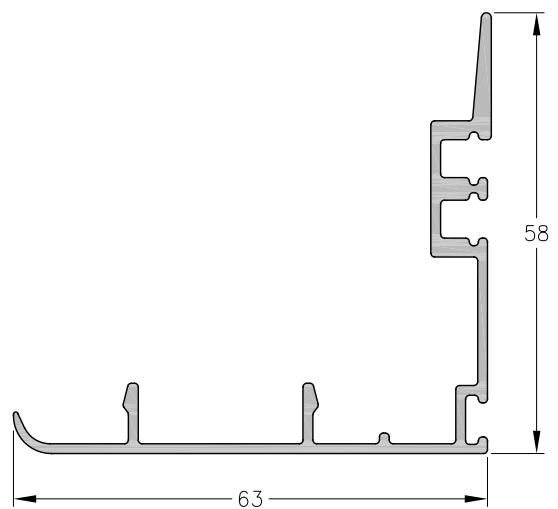

1060609 - Encuentro
Peso: 0,66 Kg/m.
Largo Std.: 6.150 mm.

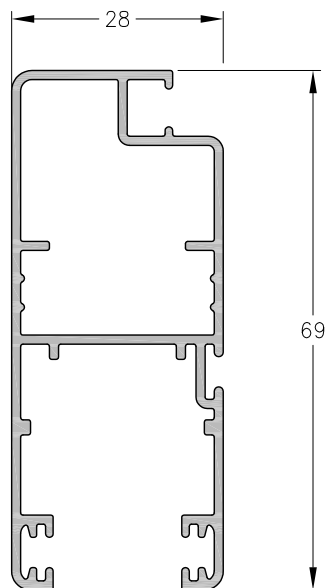

1060738 - Mosquitero Reforzado
peso: 0,80 Kg/m

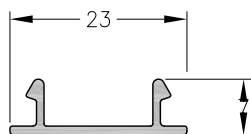

1060739 - Tapa Mosquitero Reforzado
peso: 0,13 Kg/m

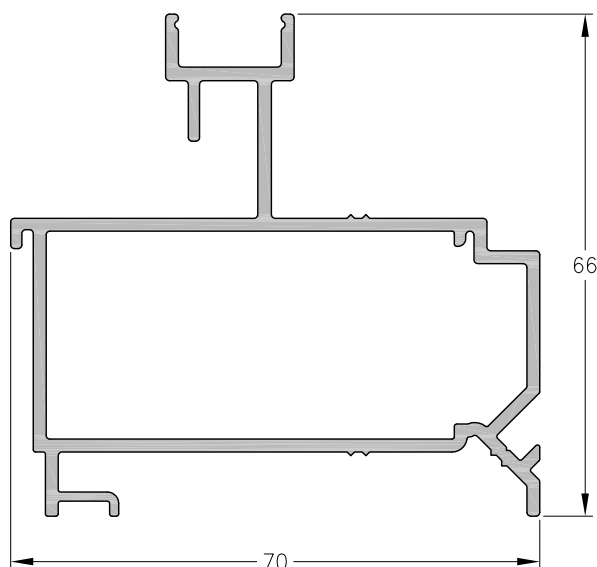

1060603 - Marco postizo
Peso: 1,30 Kg/m
Largo Std.: 6150 mm

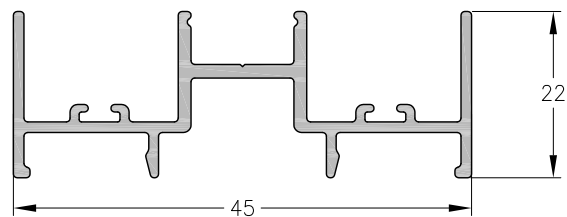

1060607 - Encuentro de Cuatro Hojas
Peso: 0,62 Kg/m.
Largo Std.: 6.030 mm.

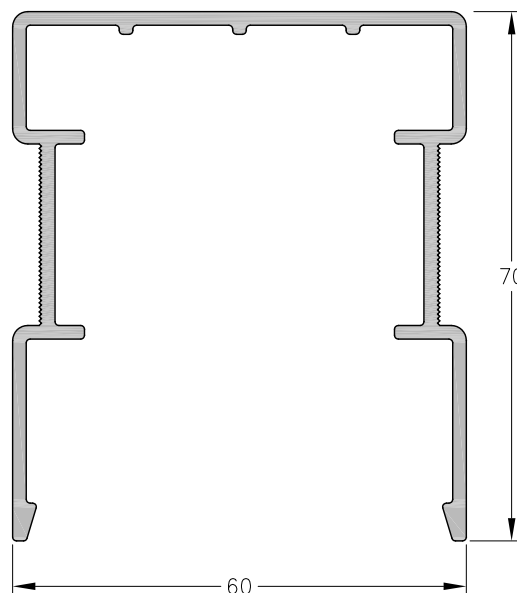

1060599 - Tapa Inercial
Peso: 1,15 Kg/m.
Largo Std.: 6.030 mm.

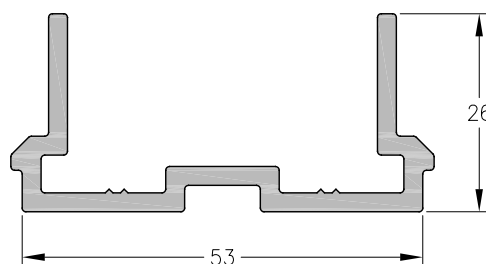

1060600 - Base Inercial
Peso: 0,80 Kg/m.
Largo Std.: 6.030 mm.

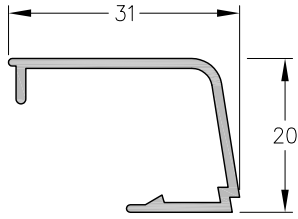

1060870 - Contravidrio
 Peso: 0,23 Kg/m.
 Largo Std.: 6.030 mm.

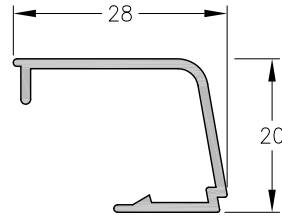

1060380 - Contravidrio
 Peso: 0,22 Kg/m.
 Largo Std.: 6.030 mm.

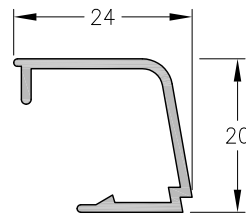

1060698 - Contravidrio
 Peso: 0,20 Kg/m.
 Largo Std.: 6.030 mm.

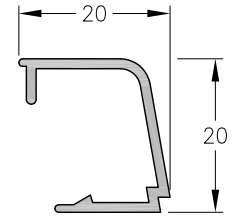

1060525 - Contravidrio
 Peso: 0,19 Kg/m.
 Largo Std.: 6.030 mm.

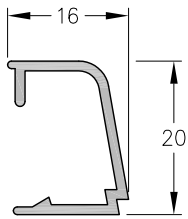

1060523 - Contravidrio
 Peso: 0,17 Kg/m.
 Largo Std.: 6.030 mm.

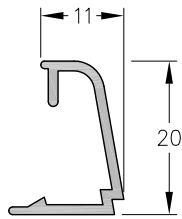

1060705 - Contravidrio
 Peso: 0,16 Kg/m.
 Largo Std.: 6.030 mm.

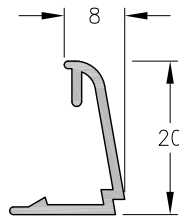

1060526 - Contravidrio
 Peso: 0,15 Kg/m.
 Largo Std.: 6.030 mm.

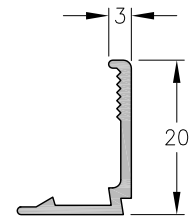

1060699 - Contravidrio
 Peso: 0,13 Kg/m.
 Largo Std.: 6.030 mm.

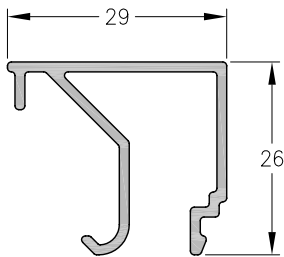

1060876 - Contravidrio
 Peso: 0,33 Kg/m.
 Largo Std.: 6.030 mm.

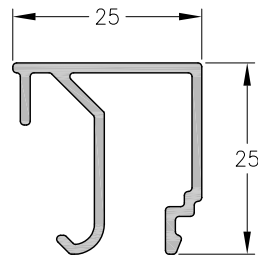

1060880 - Contravidrio
 Peso: 0,32 Kg/m.
 Largo Std.: 6.030 mm.

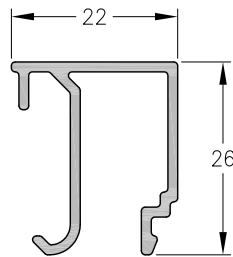

1060877 - Contravidrio
 Peso: 0,30 Kg/m.
 Largo Std.: 6.030 mm.

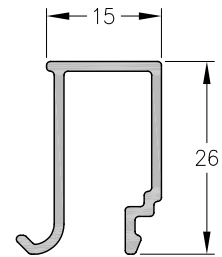

1060878 - Contravidrio
 Peso: 0,25 Kg/m.
 Largo Std.: 6.030 mm.

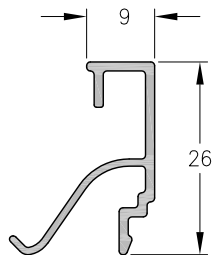

1060885 - Contravidrio
 Peso: 0,20 Kg/m.
 Largo Std.: 6.030 mm.

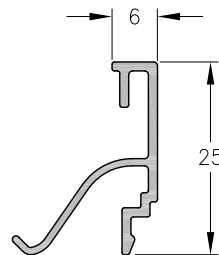

1060887 - Contravidrio
 Peso: 0,19 Kg/m.
 Largo Std.: 6.030 mm.

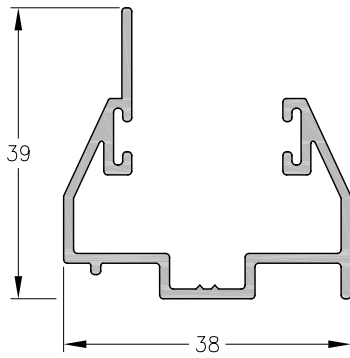

1060577 - Guía Postiza Cortina
Peso: 0,49 Kg/m.
Largo Std.: 6.150 mm.

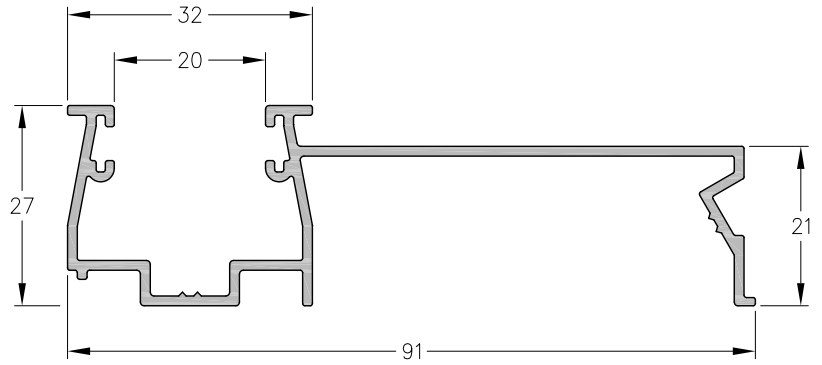

153 - Guía de Cortina Común
Peso: 0,70 Kg/m
Largo Std.: 6150 mm



154 - Guía de Cortina Regulable (Tipo Barrio)
Peso: 1,02 Kg/m
Largo Std.: 6150 mm

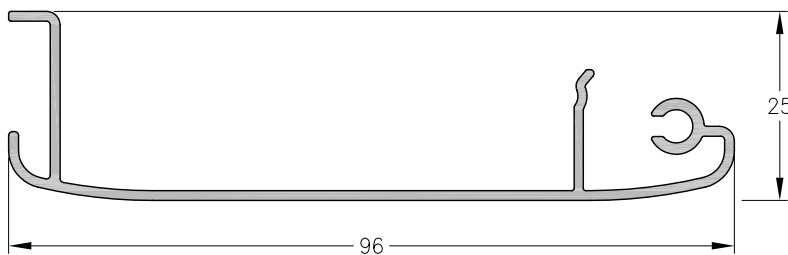

1060683 - Tapacinta
Peso: 0,60 Kg/m.
Largo Std.: 6.150 mm.

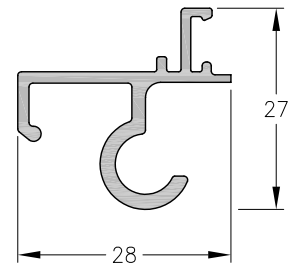

1060843 - Bisagra Tapacinta
Peso: 0,34 Kg/m.
Largo Std.: 6.150 mm.

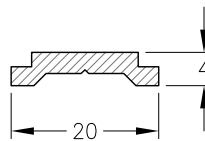

9469 - Pletina de Poliamida
Largo Std.: 6.150 mm.

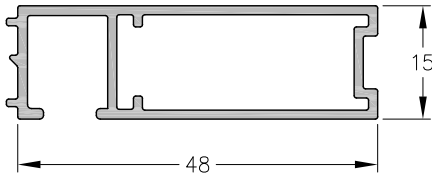

1060647 - Premarco de 48 mm.
Peso: 0,46 Kg/m.
Largo Std.: 6.150 mm.

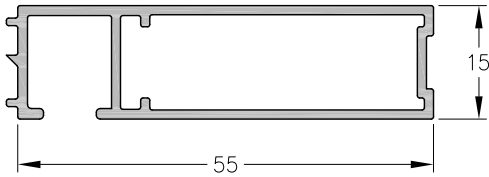

1060648 - Premarco de 55 mm.
Peso: 0,50 Kg/m.
Largo Std.: 6.150 mm.

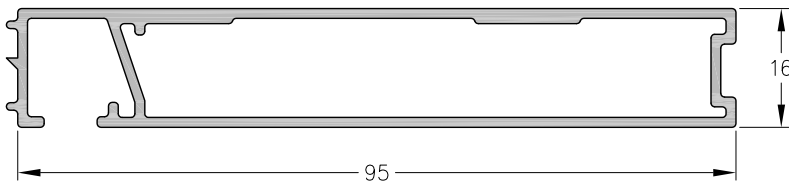

1060875 - Premarco de 95 mm.
Peso: 0,88 Kg/m.
Largo Std.: 6.150 mm.

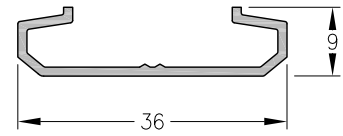

1060562 - Perfil de Fijación
Inferior Marco-Premarco
Peso: 0,19 Kg/m.
Largo Std.: 6.030 mm.

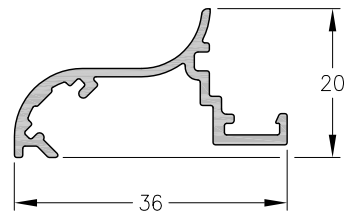

1060727 - Embellecedor
de Marco
Peso: 0,26 Kg/m.
Largo Std.: 6.030 mm.

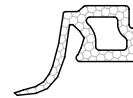

9417 - Burlete de EPDM

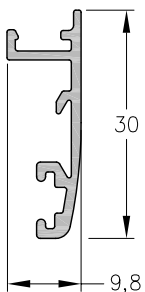

1060884 - Contramarca
Peso: 0,20 Kg/m.
Largo Std.: 6.150 mm.

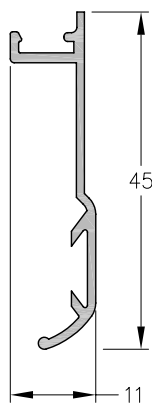

1060862 - Contramarca
Peso: 0,21 Kg/m.
Largo Std.: 6.150 mm.

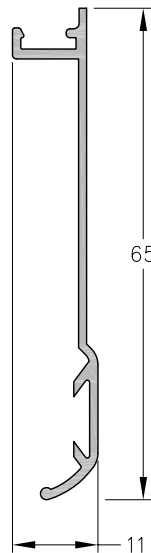

1060857 - Contramarca
Peso: 0,27 Kg/m.
Largo Std.: 6.150 mm.

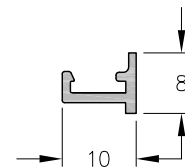

1060310 - Tapa Terminación
Coplanar Marco
Peso: 0,07 Kg/m.
Largo Std.: 6.150 mm.

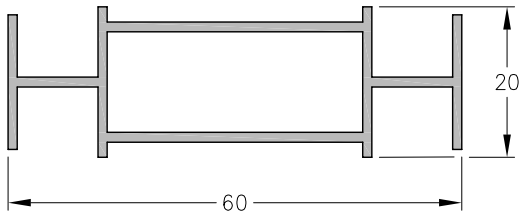

1060568 - Acople Recto
Peso: 0,56 Kg/m.
Largo Std.: 6.030 mm.

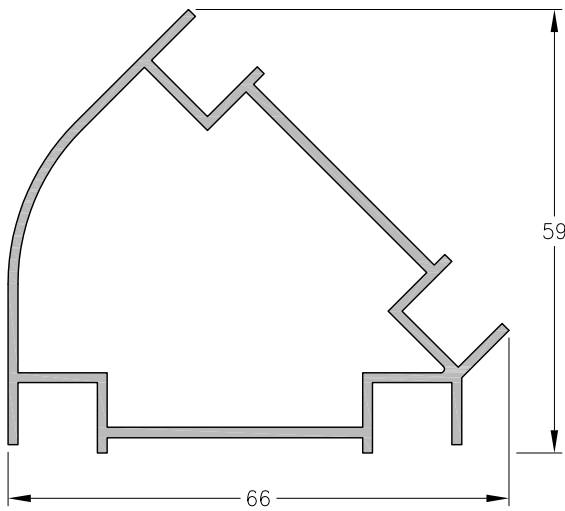

1060563 - Columna Curva a 135°
Peso: 0,85 Kg/m.
Largo Std.: 6.030 mm.

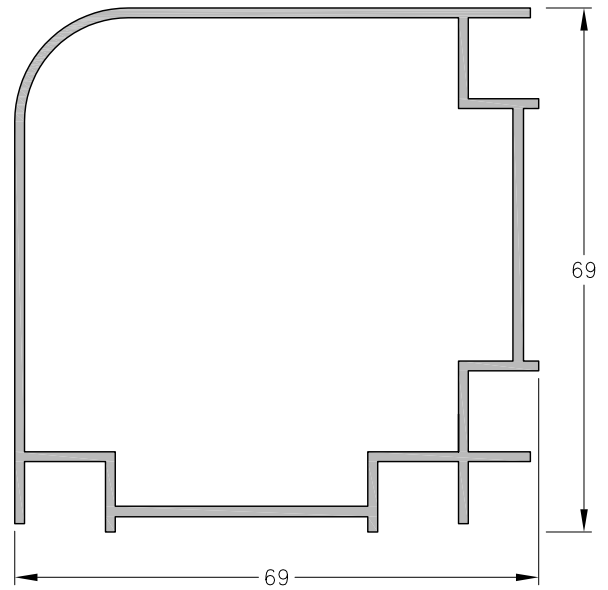

1060564 - Columna Curva a 90°
Peso: 1,07 Kg/m.
Largo Std.: 6.030 mm.

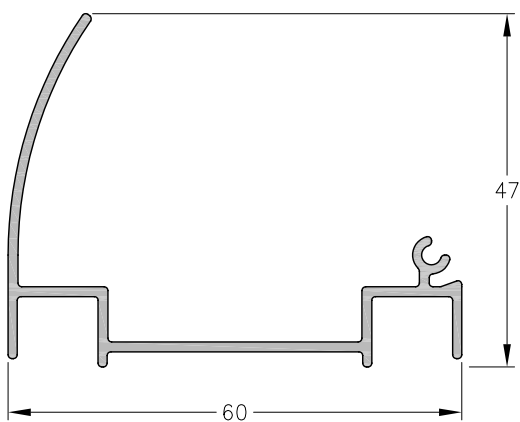

1060596 - Rótula Exterior
Peso: 0,50 Kg/m.
Largo Std.: 6.030 mm.

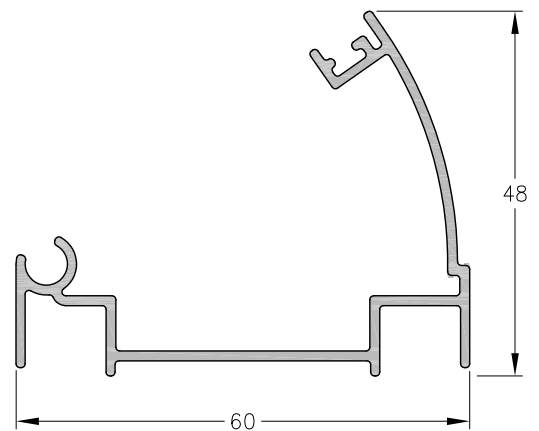

1060595 - Rótula Interior
Peso: 0,58 Kg/m.
Largo Std.: 6.030 mm.

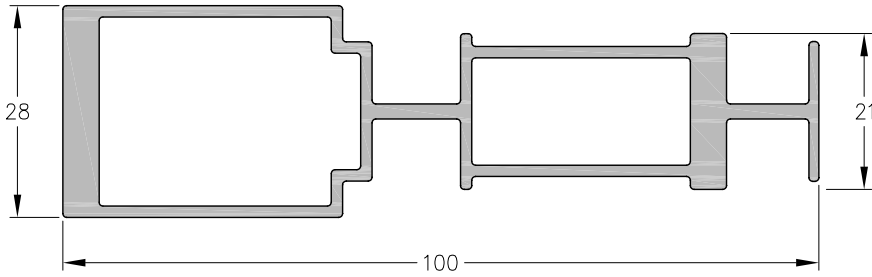

1060850 - Acople Recto Reforzado
Peso: 1,55 Kg/m.
Largo Std.: 6.030 mm.

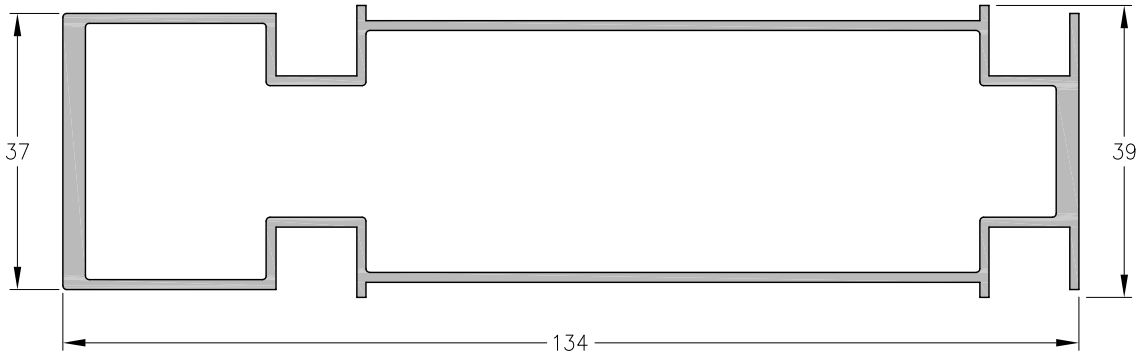

1060854 - Acople Recto Reforzado
Peso: 1,60 Kg/m.
Largo Std.: 6.030 mm.

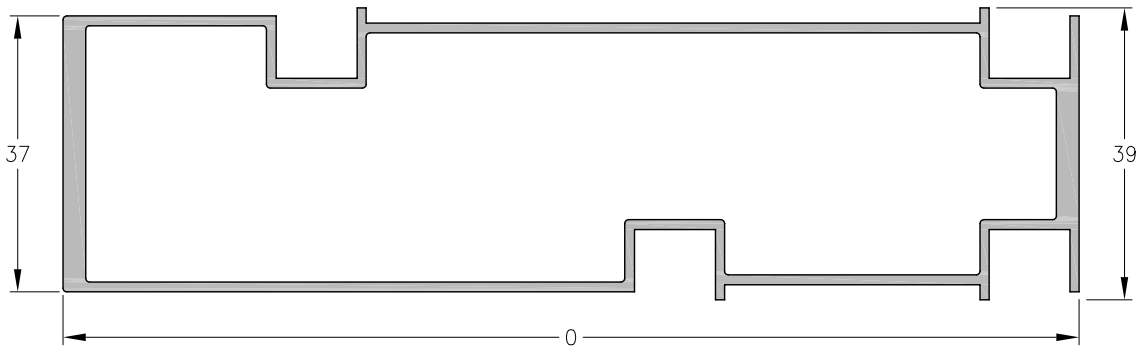

1060855 - Acople Recto Reforzado
Peso: 1,59 Kg/m.
Largo Std.: 6.030 mm.