

# MANUAL DE ARMADO SISTEMA NIZA



- 4 ..... Contramarcos
- 5 ..... Premarcos
- N-Uno
- 6 ..... Ventana y Puerta Corrediza Hoja a 45°
- N-Tres
- 10 ..... Paño fijo
- 12 ..... Ventana de Rebatir 1 Hoja y Banderola
- 14 ..... Ventana de Rebatir 2 Hojas
- 16..... Puerta de Rebatir no Coplanar
- 20 ..... Puerta de Rebatir Coplanar
- 24..... Ventana Desplazable a Tijera
- 26 ..... Ventana y Puerta Corrediza
- 38 ..... Ventana y Puerta corrediza encuentro a 90°
- 42..... Ventana y Puerta Fijo Móvil
- N-Cinco
- 48 ..... Paño Fijo
- 50 ..... Ventana de Rebatir 1 Hoja y Banderola
- 52 ..... Ventana de Rebatir 2 Hojas
- 54 ..... Ventana Desplazable a Tijera
- 56 ..... Puerta de Rebatir
- 60 ..... Ventana y Puerta Corrediza
- 72..... Ventana y Puerta Fijo Móvil
- 80 ..... Refuerzos Inerciales
- 81 ..... Acoples

La Línea Niza ofrece tres niveles de prestación:

N-Uno: Media prestación para dimensiones convencionales  
 N-Tres: Alta prestación para dimensiones convencionales

N-Cinco: Alta prestación para grandes dimensiones

**Peso de las Barras de Perfiles:** El peso por metro de los perfiles es estimado, con una tolerancia de + / - 10%.

**Largo de las Barras de Perfiles:** La medida Standard de las Barras de Perfiles es de 6.030 milímetros, salvo aclaración en contrario.

**Alsafex S.A.** se reserva el derecho de realizar cambios y/o modificaciones sin previo aviso de los contenidos y artículos indicados en el presente catálogo.

### Contramarcos

Dimensiones de Corte Contramarco 657	Ventana			Puerta		
	Cant.	Largo	Corte	Cant.	Largo	Corte
	2	A+53	45° 45°	1	A+53	45° 45°
2	H+53	45° 45°	2	H+26	45° 90°	

Accesorios Contramarco 657 / 649				
Código	Descripción	Forma	Ventana	Puerta
8919	Esc. Contramarco E-66		4 Unidades	2 Unidades
8440	Burlete B-57		s/m	s/m
8426	Clip Contramarco T-87		s/m	s/m
8043	Clip Contramarco T-115		s/m	s/m

s/m: según medida.

Accesorios Contramarco 657				
Código	Descripción	Forma	Ventana	Puerta
8919	Esc. Contramarco E-66		4 Unidades	2 Unidades

Accesorios Contramarco 657				
Código	Descripción	Forma	Ventana	Puerta
8919	Esc. Contramarco E-66		4 Unidades	2 Unidades

s/m: según medida.

Dimensiones de Corte Contramarco 641	Ventana			Puerta		
	Cant.	Largo	Corte	Cant.	Largo	Corte
	2	A+80	45° 45°	1	A+80	45° 45°
2	H+80	45° 45°	2	H+40	45° 90°	

Accesorios Contramarco 657				
Código	Descripción	Forma	Ventana	Puerta
8951	Esc. Contramarco Parte 008		4 Unidades	2 Unidades

s/m: según medida.

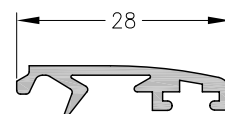

1020657 - Contramarco  
peso: 0,19 Kg/m

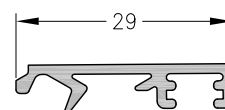

1020649 - Contramarco  
Peso: 0,19 Kg/m  
Largo Std.: 6150 mm

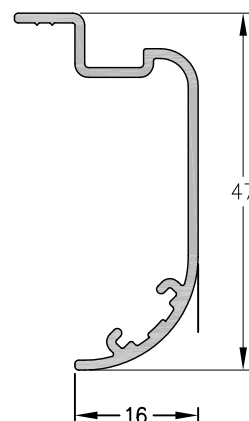

1020641 - Contramarco  
peso: 0,32 Kg/m

Dimensiones de Corte Premarco 647		
Cant.	Largo	Corte
2	A+36	45° 45°
2	H+36	45° 45°

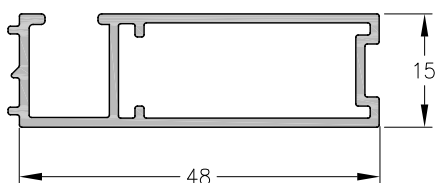





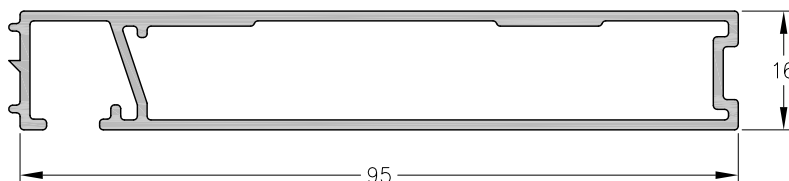

1060647 - Premarco de 48 mm.  
 Peso: 0,46 Kg/m.  
 Largo Std.: 6.150 mm.

Dimensiones de Corte Premarco 875		
Cant.	Largo	Corte
2	A+38	45° 45°
2	H+38	45° 45°



875 - Premarco  
 largo std.: 6150 mm  
 peso: 0,88 Kg/m

Accesorios Premarco				
Ítem	Código	Descripción	Forma	Cantidad
Esc. de Armado	8723	Escuadra para Premarco 648 E-78		4 Unidades
	8032	Escuadra para Premarco 875 (74 mm.)		
Taco de Regul.	8927	Taco de Regulación T-88, para Perfiles de Marco		s/m
Tornillo	-	Tornillo de Fijación		s/m
Tapa Tornillo	8945	Tapa Cabeza de Tornillo T-95		s/m
Grampa	8722	Grampa de Amure		s/m
Esquinero	8724	Escuadra Esquinera de Premarco		4 Unidades

s/m: según medida.

B-B Corte Vertical

Vista

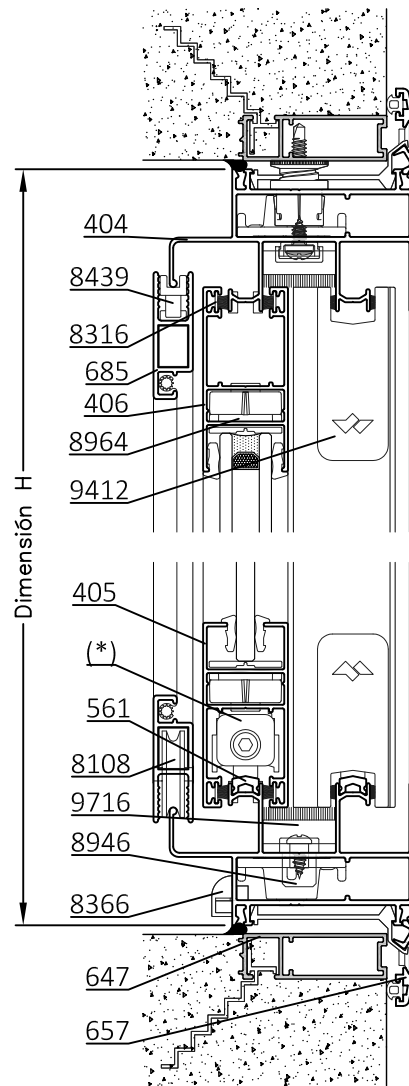
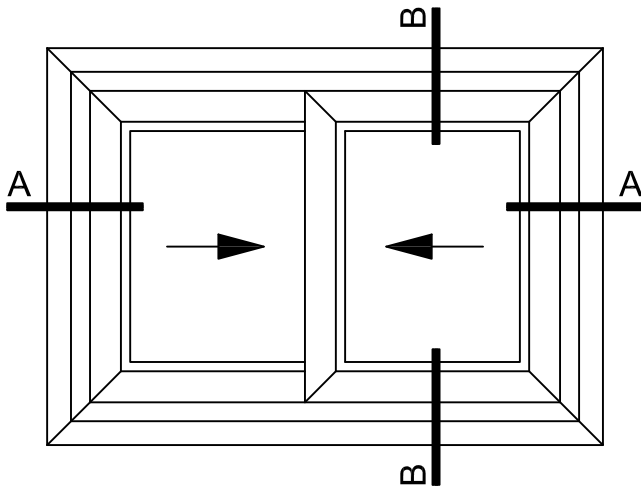





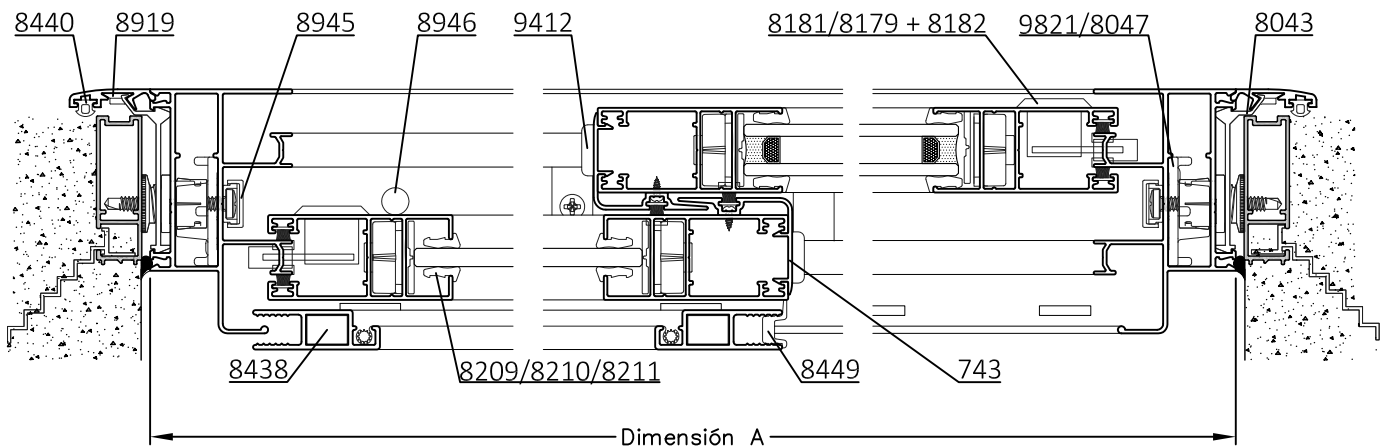

(\*) ver tabla de ruedas

A-A Corte Horizontal

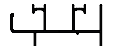

Escala 1: 2.5

















Tolerancia en Peso +/- 10%

Dimensiones de Corte						
Código	Peso Kg/m	Forma	Función	Cant.	Largo	Corte
1110404	1,16		Marco	2	A	45° 45°
				2	H	45° 45°
1060561 1060543	0,09 0,13		Guía Inf. Marco	2	A-88	90° 90°
1110405	0,72		Hoja	4	A/2-8	45° 45°
1110406	0,68			4	H-78	45° 45°
1060743	0,30		Encuentro Central	2	H-78	90° 90°
1020638	0,70		Travesaño p/405	2	A/2-101	90° 90°
1020681	0,70		Travesaño p/406	2	A/2-101	90° 90°
1020685	0,38		mosquitero	2	A/2-5	45° 45°
				2	H-68	45° 45°

Dimensiones de Corte Contramarco: pág. 3



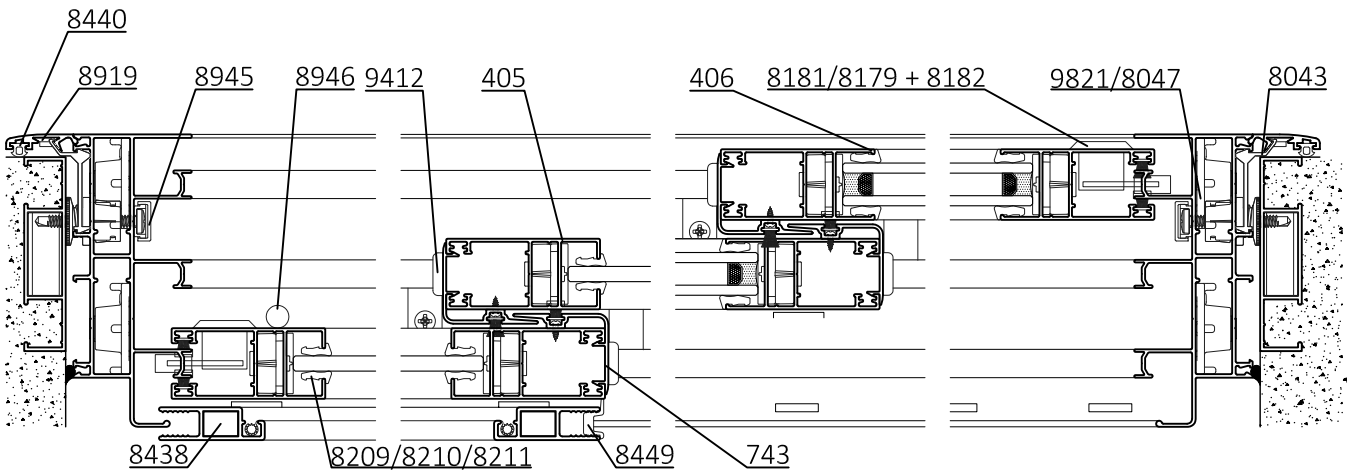
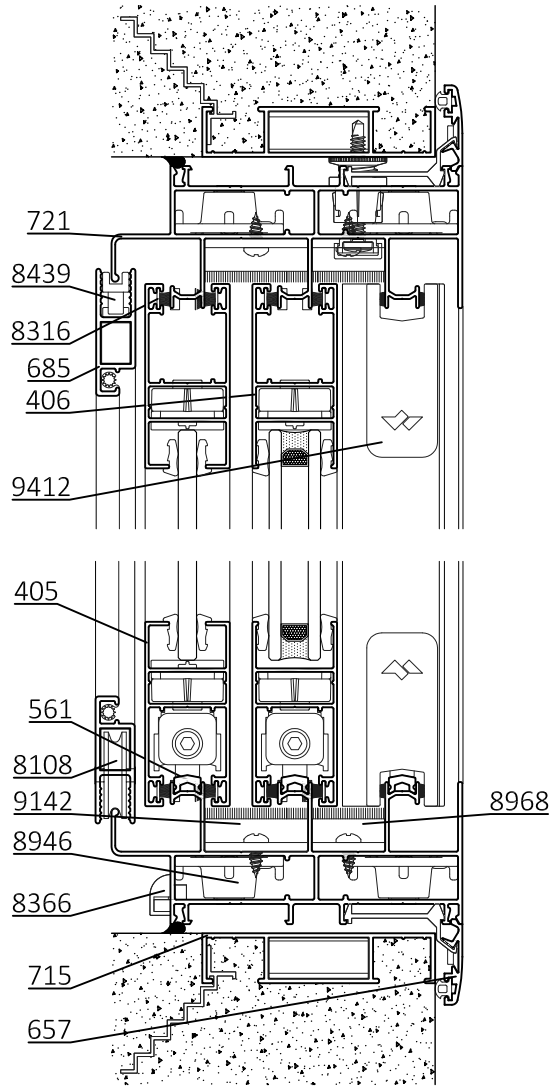
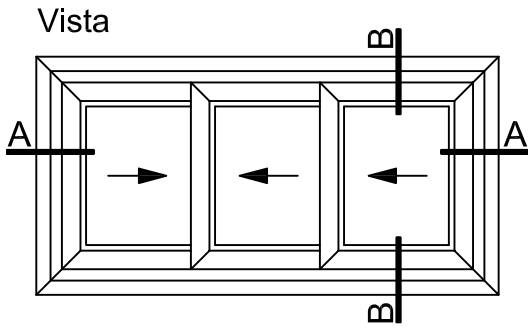

\* Medidas en milímetros

Dimensiones de Corte Premarco: pág. 4

Detalle de Accesorios				
Ítem	Código	Descripción	Forma	Cantidad
Esc. de Armado	9821 8047	Esc. de Armado Marco E-83		4 Unidades
	8964	Escuadra Armado de Hoja CON-359 E-97		8 Unidades
Esc. Alineación	8949	Escuadra de Alineamiento Hoja E-98		16 Unidades
Tornillos	8941	Tornillo Fijador Perfil 743		s/m
Cuña Vidrio	8209	Cuña Chica		4A + 8H
	8210	Cuña Mediana		
	8211	Cuña Grande		
Felpa	8942	Felpa de 7x6		4A + 6H
	8943	Felpa de 7x6 con Fin Seal		
Manija	9440	Manijas Acodadas Modelo SR Izq / Der	-	2 Unidades
	9452	Manija Recta Modelo SR		
Cierre Lateral	9430/31/32	Mecanismo de Cierre de 1 , 2 y 3 Puntos	-	2 Unidades
	8181/8179	Cierre Lateral Milano Autom./Manual 2 Pos.		
	8182	Kit de Cierre Lateral Milano		
Tope Lateral	8965	Tope Lateral BAT-937		1 Juego
Rodamientos guía 561 	8962	Rueda Simple 3304		4 Unidades
	8967	Rueda Simpl. Reg. c/Rul. (Max 50 Kg/Hoja)		
	8963	Rueda Dobl. Reg. c/Rul. (Max. 100Kg/Hoja)		
	9154	Rueda Dobl. Reg. c/Aguj. (Max. 150Kg/Hoja)		
	8130	Rueda Dobl. Reg. Optimus (160Kg/Hoja)		
Rodamientos guía 543 	8961	Rueda Simpl. Reg. c/Rul. (Max 40 Kg/Hoja)		4 Unidades
	8959	Rueda Dobl. Reg. c/Rul. (Max. 80Kg/Hoja)		
Tope Central	9412	Tope Parante Central T-118		4 Unidades
Cruce de Hoja	9716	Cruce de Hoja		2 Unidades
Boca Desagüe	8946	Boca Desagüe T-94 T-130		s/m
Tapa Desagüe	8366	Tapa Desagüe T-69 T-131		2 Unidades
Tapón Hermetic.	9720	Tapón de Hermeticidad Caja de Agua		2 Unidades
Tapón (Opción con Tirador)	9708	Tapón Tirador Central, Perfil 518		2 Unidades

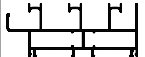

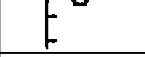

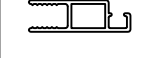

















Dimensiones de Corte						
Código	Peso Kg/m	Forma	Función	Cant.	Largo	Corte
1110721	1,68		Marco	2	A	45° 45°
				2	H	45° 45°
1060561	0,09		Guía Inf. Marco	3	A-88	90° 90°
1060543	0,13					
1110405	0,72		Hoja	6	A/3+16	45° 45°
1110406	0,68			6	H-78	45° 45°
1060743	0,30		Encuentro Central	2	H-78	90° 90°
1020638	0,70		Travesaño p/405	3	A/3-77	90° 90°
1020681	0,70		Travesaño p/406	3	A/3-77	90° 90°
1020685	0,38		mosquitero	2	A/2-5	45° 45°
				2	H-68	45° 45°

Dimensiones de Corte Contramarco: pág. 3

\* Medidas en milímetros

Dimensiones de Corte Premarco: pág. 4

Detalle de Accesorios						
Ítem	Código	Descripción	Forma	Cantidad		
Esc. de Armado	9821 8047	Esc. de Armado Marco E-83		8 Unidades		
	8964	Escuadra Armado de Hoja CON-359 E-97		12 Unidades		
Esc. Alineación	8949	Escuadra de Alineamiento Hoja E-98		24 Unidades		
Tornillos	8941	Tornillo Fijador Perfil 743		s/m		
Cuña Vidrio	8209	Cuña Chica		4A + 12H		
	8210	Cuña Mediana				
	8211	Cuña Grande				
Felpa	8942	Felpa de 7x6		4A + 8H		
	8943	Felpa de 7x6 con Fin Seal				
Manija	9440	Manijas Acodadas Modelo SR Izq / Der	-	2 Unidades		
	9452	Manija Recta Modelo SR				
Cierre Lateral	9430/31/32	Mecanismo de Cierre de 1 , 2 y 3 Puntos	-	2 Unidades		
	8181/8179	Cierre Lateral Milano Autom./Manual 2 Pos.				2 Unidades
	8182	Kit de Cierre Lateral Milano				2 Unidades
Tope Lateral	8965	Tope Lateral BAT-937		1 Juego		
Rodamientos guía 561 	8962	Rueda Simple 3304		6 Unidades		
	8967	Rueda Simpl. Reg. c/Rul. (Max 50 Kg/Hoja)				
	8963	Rueda Dobl. Reg. c/Rul. (Max. 100Kg/Hoja)				
	8130	Rueda Dobl. Reg. Optimus (120Kg/Hoja)				
	9154	Rueda Dobl. Reg. c/Aguj. (Max. 150Kg/Hoja)				
Rodamientos guía 543 	8961	Rueda Simpl. Reg. c/Rul. (Max 40 Kg/Hoja)		6 Unidades		
	8959	Rueda Dobl. Reg. c/Rul. (Max. 80Kg/Hoja)				
Tope Central	9412	Tope Parante Central T-118		8 Unidades		
Cruce de Hoja	8968	Cruce de Hoja		4 Unidades		
Cruce de Hoja	9142	Cruce de Hoja		4 Unidades		
Boca Desagüe	8946	Boca Desagüe T-94 T-130		s/m		
Tapa Desagüe	8366	Tapa Desagüe T-69 T-131		2 Unidades		
Tapón Hermetic.	9720	Tapón de Hermeticidad Caja de Agua		2 Unidades		

Vista

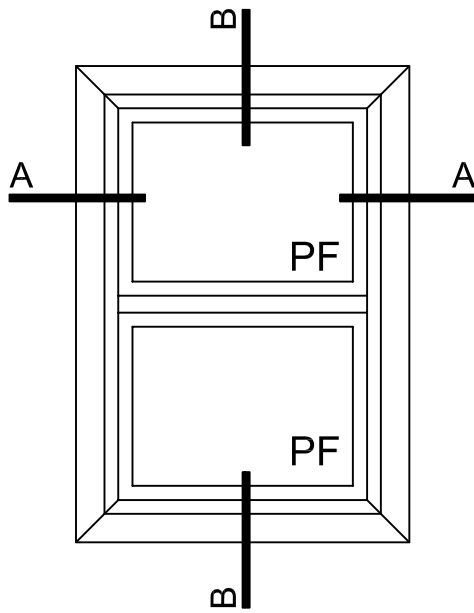

B-B Corte Vertical

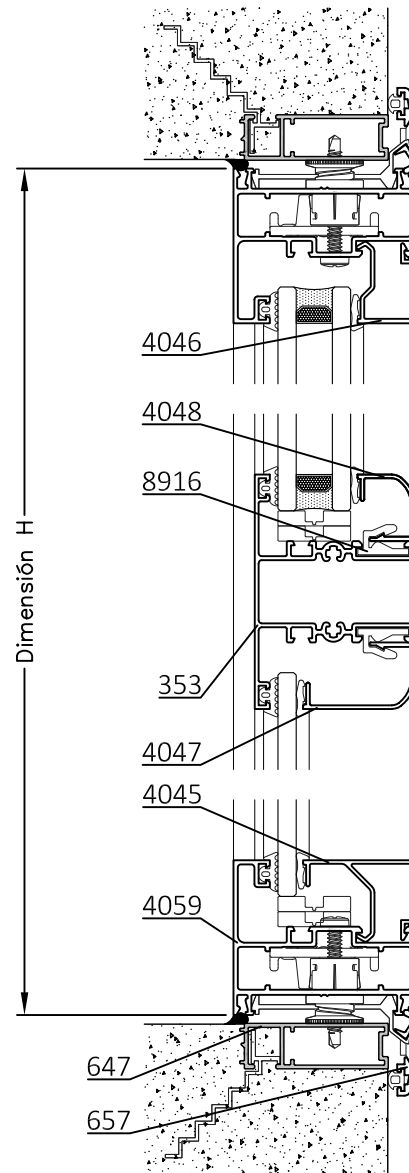

A-A Corte Horizontal

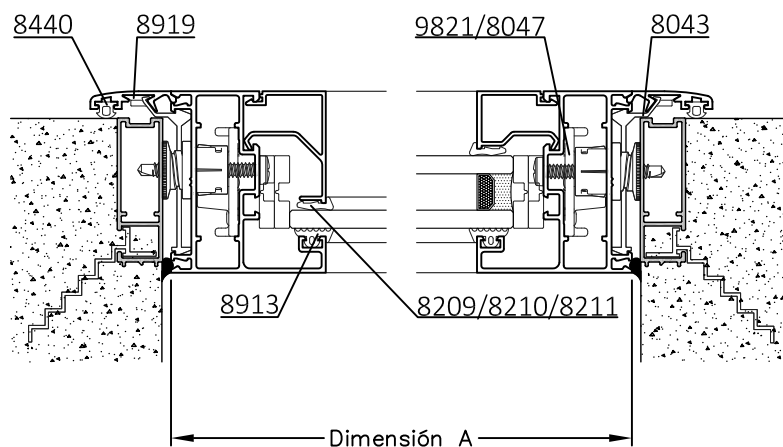

Dimensiones de Corte						
Código	Peso Kg/m	Forma	Función	Cant.	Largo	Corte
4059	1,00		Marco	2	A	45° 45°
				2	H	45° 45°
4047/4048/ 4050/193/194/195	-	-	Contrav. con clip	2	A-59	45° 45°
				2	H-59	45° 45°
4045/4046/ 4049	-	-	Contrav. Recto	2	A-59	90° 90°
				2	H-103	90° 90°
1110353	1,05		Travesaño	-	(AoH)-59	90° 90°

Dimensiones de Corte Contramarco: pág. 3

\* Medidas en milímetros

Dimensiones de Corte Premarco: pág. 4

Detalle de Accesorios				S/Travesaño	C/ 1 Travesaño
Ítem	Código	Descripción	Forma	Cantidad	Cantidad
Esc. de Armado	9821 8047	Esc. de Armado Marco E-83		4 Unidades	
Clip	8916	Clip Contravidrios T-96		s/m	s/m
Burlete Vidrio	8913	Burlete de Acristalamiento B-68		2A + 2H	2A + 2H + 2 Largos x Trav.
Cuña Vidrio	8209	Cuña Chica		2A + 2H	2A + 2H + 2 Largos x Trav.
	8210	Cuña Mediana			
	8211	Cuña Grande			
Tornillo	8368	Tornillo Parker Parte I		-	4 Unidades x Travesaño

s/m: según medida

Accesorios Contramarco: pág.3 Accesorios Premarco: pág. 4

Es posible combinar el Paño Fijo con Ventanas de Rebatir, Ventanas Oscilo-Batientes y Ventanas Banderola utilizando un mismo Marco Perimetral. Se plantean las dos opciones de marco dentro de un mismo detalle

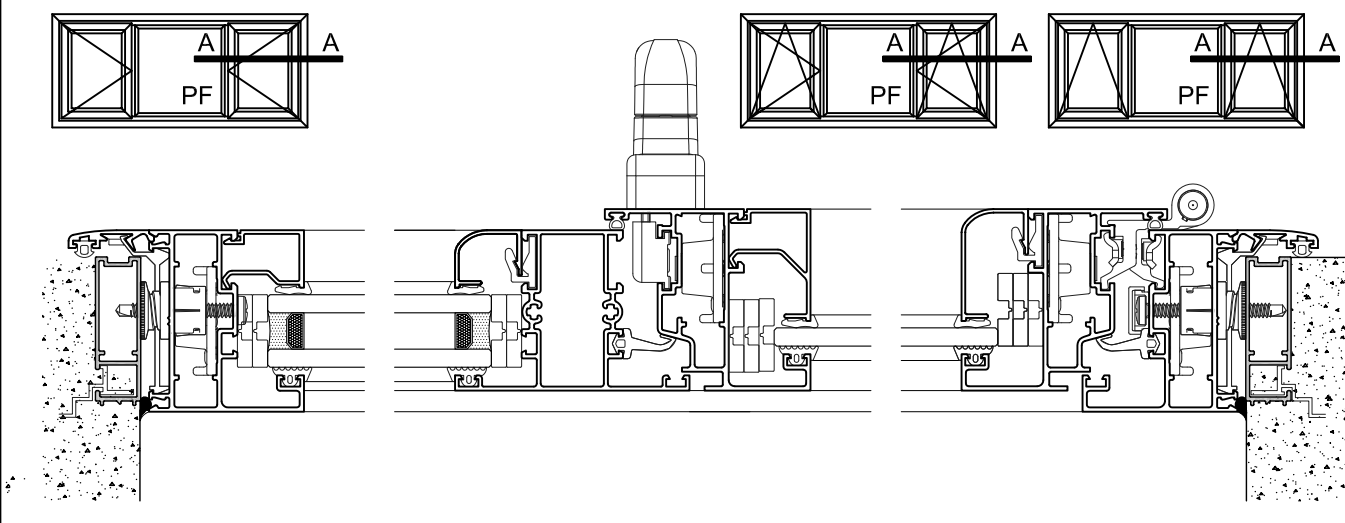

Escala 1:2.5

Tolerancia en Peso +/- 10%

Vista

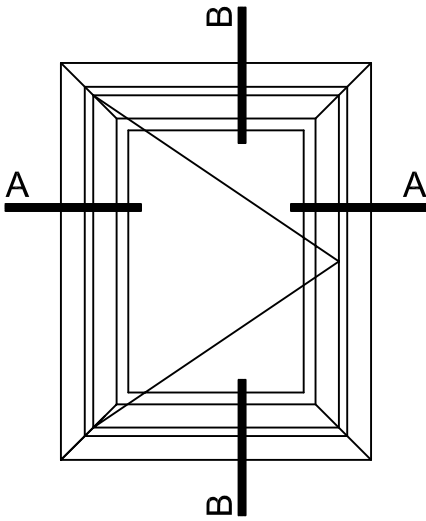

B-B Corte Vertical

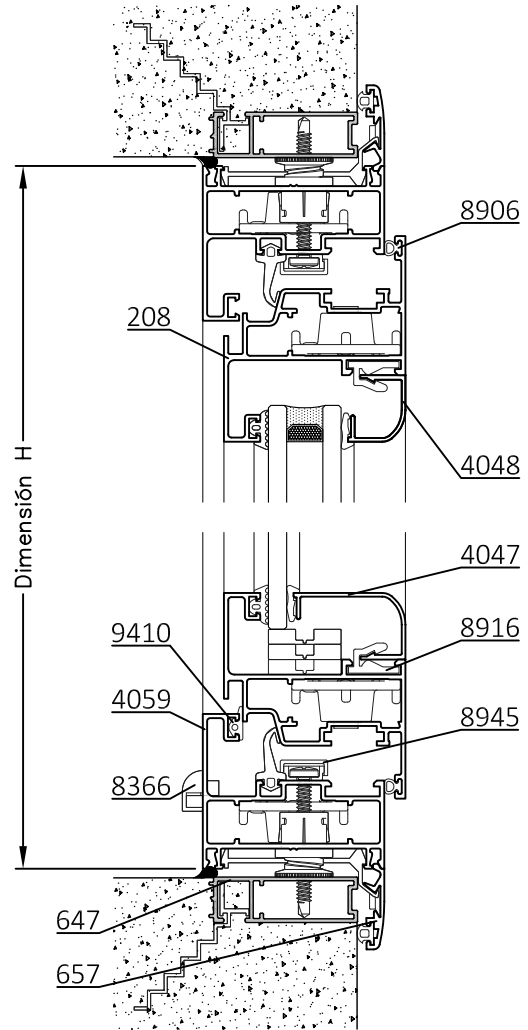

Opción Banderola

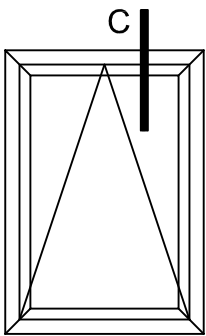

Corte C

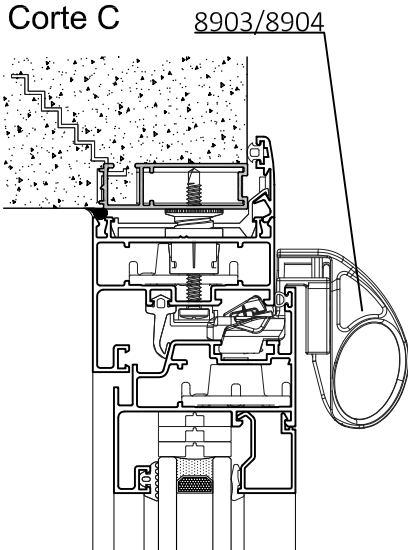

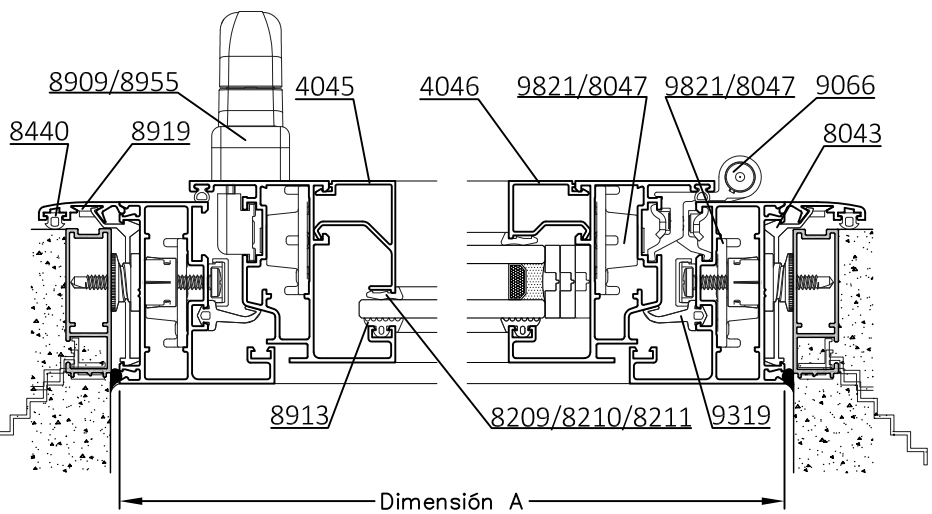

A-A Corte Horizontal



Escala 1: 2.5

Tolerancia en Peso +/- 10%









Dimensiones de Corte				De Rebatir			Banderola		
Código	Peso Kg/m	Forma	Función	Cant.	Largo	Corte	Cant.	Largo	Corte
4059	1,00		Marco	2	A	45° 45°	2	A	45° 45°
				2	H	45° 45°	2	H	45° 45°
9469	0,07(Varilla)		Pletina	2	S/F	90° 90°	-	-	-
1110208	1,06		Hoja	2	A-47	45° 45°	2	A-47	45° 45°
				2	H-47	45° 45°	2	H-47	45° 45°
4047/4048/ 4050/193/194/195	-	-	Contrav. con clip	2	A-139	45° 45°	2	A-139	45° 45°
				2	H-139	45° 45°	2	H-139	45° 45°
4045/4046/ 4049	-	-	Contrav. Recto	2	A-139	90° 90°	2	A-139	90° 90°
				2	H-183	90° 90°	2	H-183	90° 90°

Dimensiones de Corte Contramarco: pág. 3

S/F: Dimensiones de Corte según Falleba

Dimensiones de Corte Premarco: pág. 4

\* Medidas en milímetros

Detalle de Accesorios				De Rebatir	Banderola
Ítem	Código	Descripción	Forma	Cantidad	Cantidad
Esc. de Armado	9821 8047	Esc. de Armado Marco y Hoja E-83		8 Unidades	8 Unidades
Clip	8916	Clip Contravidrios T-96		s/m	s/m
Burlete Vidrio	8913	Burlete de Acristalamiento B-68		2A + 2H	2A + 2H
Cuña Vidrio	8209	Cuña Chica		4A + 4H (2)	4A + 4H (2)
	8210	Cuña Mediana		2A + 2H (1)	2A + 2H (1)
	8211	Cuña Grande			
Burlete Hermetic.	8906	Burlete AEL europeo		2A + 2H	2A + 2H
	9320	Esq. Vulcanizado Burlete B-75		4 Unidades	4 Unidades
	9319	Burlete Cámara Compensada B-74		2A <sub>(a)</sub> + 2H <sub>(a)</sub>	2A <sub>(a)</sub> + 2H <sub>(a)</sub>
Cierre	8909	Falleba Prima H-47 con Kit		1 Unidad	-
	8955	Falleba Nova H-86 con Kit			
	8904	Traba Banderola H-52			
Brazo Sostén	8443	Brazo Sostén Banderola H-53	-	-	1 Par
Sostén de Hoja	8433	Sostén de Hoja H-44	-	1 Unidad	1 Unidad
Bisagra	8908	Bisagra H-61 de 2 piezas con Kit		2 Unidades	2 Unidades
Tapa Desagüe	8366	Tapa Desagüe T-69 T-131		2 Unidades	2 Unidades

s/m: según medida.

Accesorios Contramarco: pág. 3 Premarco: pág. 4

(\*) Para Anchos superiores a 800 milímetros se recomiendan 2 Unidades.

(a) Medida de Ancho (A) o Alto (H) surge de A-250mm o H-250mm

Vista

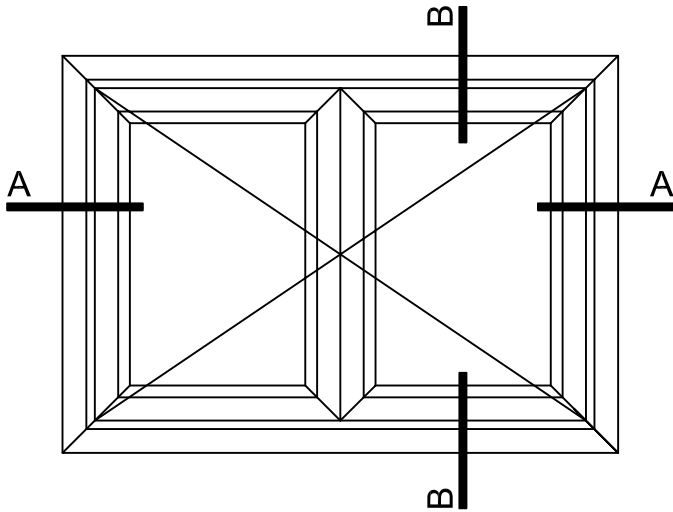

B-B Corte Vertical

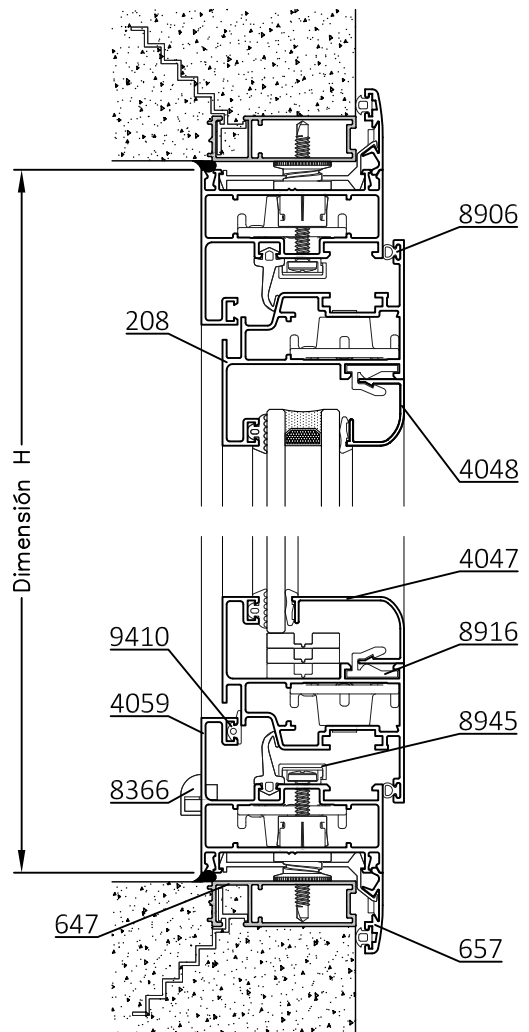



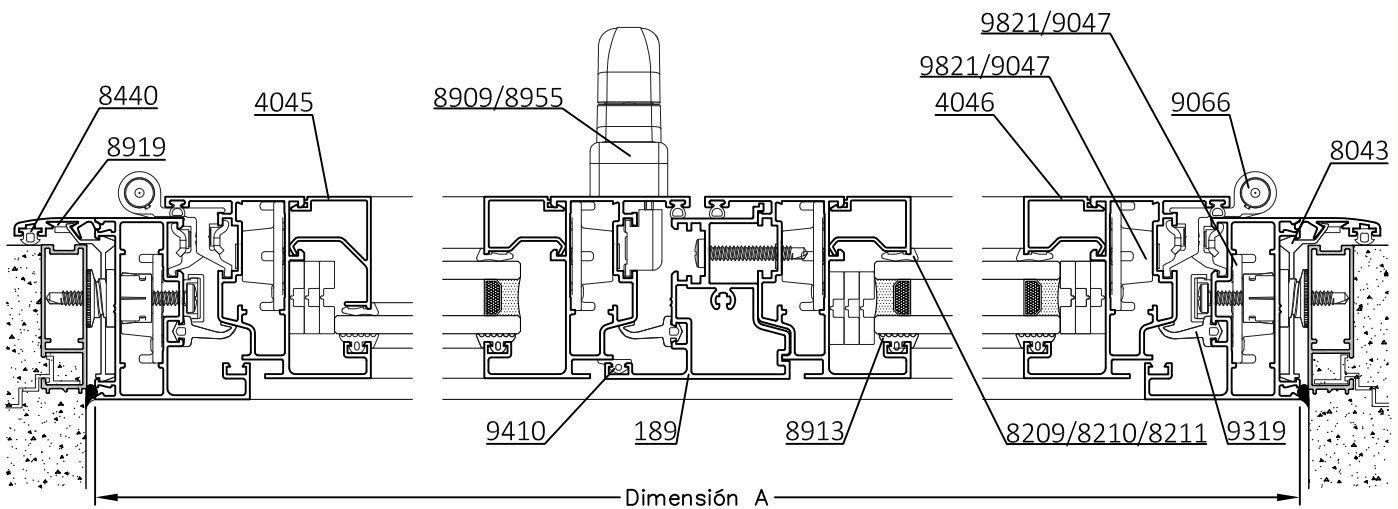

A-A Corte Horizontal



Escala 1:2.5

Tolerancia en Peso +/- 10%











Dimensiones de Corte						
Código	Peso Kg/m	Forma	Función	Cant.	Largo	Corte
4059	1,00		Marco	2	A	45° 45°
				2	H	45° 45°
Varilla 9469	0,07(Varilla)		Pletina	2	S/F	90° 90°
1110208			Hoja	2	A/2-26	45° 45°
				2	H-47	45° 45°
1110189	1,09		Inversor	1	H-112	90° 90°
4047/4048/ 4050/051/052/053	-	-	Contrav. con clip	2	A/2-118	45° 45°
				2	H-139	45° 45°
4045/4046/ 4049	-	-	Contrav. Recto	2	A/2-118	90° 90°
				2	H-183	90° 90°

Dimensiones de Corte Contramarco: pág. 3

S/F: Dimensiones de Corte según Falleba

Dimensiones de Corte Premarco: pág. 4

\* Medidas en milímetros

Detalle de Accesorios				De Rebatir
Ítem	Código	Descripción	Forma	Cantidad
Esc. de Armado	9821 8047	Esc. de Armado Marco y Hoja E-83		12 Unidades
Clip	8916	Clip Contravidrios T-96		s/m
Burlete Vidrio	8913	Burlete de Acristalamiento B-68		2A + 4H
Cuña Vidrio	8209	Cuña Chica		2A + 4H
	8210	Cuña Mediana		
	8211	Cuña Grande		
Burlete Hermetic.	8906	Burlete AEL europeo		2A + 3H
	9320	Esq. Vulcanizado Burlete B-75		4 Unidades
	9319	Burlete Cámara Compensada B-74		2A(a)+2H(a)+1H
Cierre	8909	Falleba Prima H-47 con Kit		1 Unidad
	8955	Falleba Nova H-86 con Kit		
Sostén de Hoja	8433	Sostén de Hoja H-44	-	1 Unidad
Traba Varilla	9129	Traba Varilla Doble H-78	-	2 Unidades
Pasador	9124	Pasador H-42 Giesse		2 Unidades
Bisagra	8908	Bisagra H-61 de 2 piezas con Kit		4 Unidades
Tapa Desagüe	8366	Tapa Desagüe T-69 T-131		2 Unidades
Tapón Inversor	9740	Tapón Inversor de Hoja T-119		1 Par

s/m: según medida.

Accesorios Contramarco: pág. 3 Premarco: pág. 4

(a) Medida de Ancho (A) o Alto (H) surge de A-250mm o H-250mm

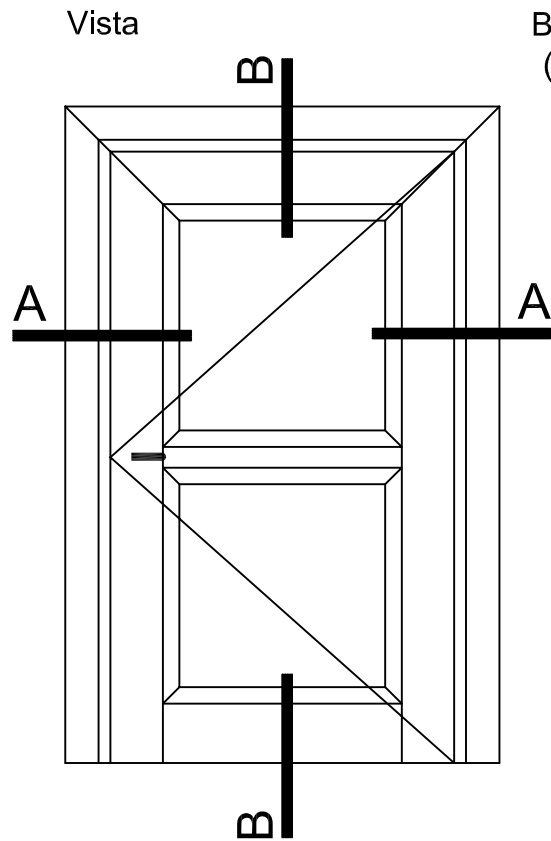

B-B Corte Vertical  
(Con Travesaño)

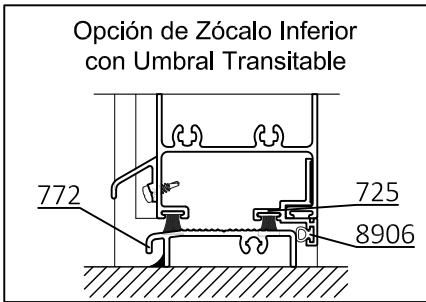
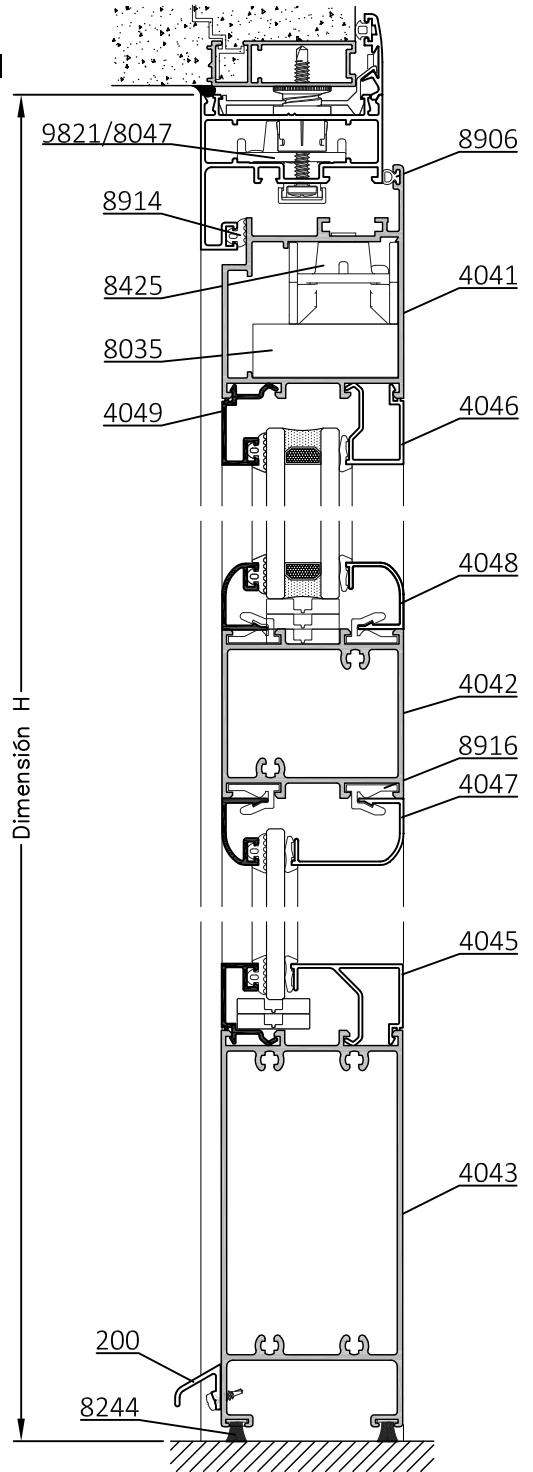



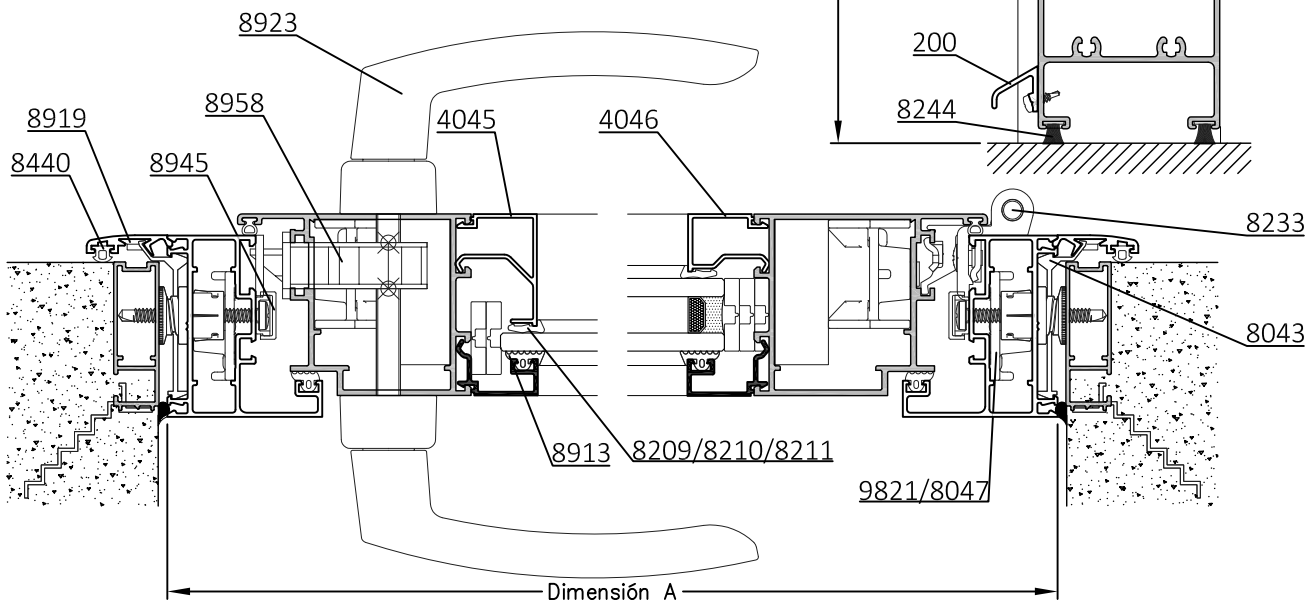

A-A Corte Horizontal



Escala 1:2.5

Tolerancia en Peso +/- 10%















Dimensiones de Corte			sin Umbral Transitable				Con Umbral		
Código	Peso Kg/m	Forma	Función	Cant.	Largo	Corte	Cant.	Largo	Corte
4059	1,00		Marco	1	A	45° 45°	1	A	45° 45°
				2	H	45° 90°	2	H	45° 90°
4041	1,39		Hoja	1	A-47	45° 45°	1	A-47	45° 45°
				2	H-28	45° 90°	2	H-39	45° 90°
4042	1,40		Travesaño	1	A-201	90° 90°	1	A-201	90° 90°
4043	2,32		Zócalo	1	A-201	90° 90°	1	A-201	90° 90°
4047/4048/ 4050/051/052/053	-	-	Contrav int. con clip	2	A-201	45° 45°	2	A-201	45° 45°
				2	H-236	45° 45°	2	H-247	45° 45°
4045/4046	-	-	Contrav int. Recto	2	A-201	90° 90°	2	A-201	90° 90°
				2	H-280	90° 90°	2	H-291	90° 90°
4050	-	-	Contrav ext. Curvo	2	A-201	45° 45°	2	A-201	45° 45°
				2	H-236	45° 45°	2	H-247	45° 45°
4049	-	-	Contrav ext. Recto	2	A-201	90° 90°	2	A-201	90° 90°
				2	H-280	90° 90°	2	H-291	90° 90°
1060200	0,15		Bota agua	1	A-244	90° 90°	1	A-244	90° 90°

Dimensiones de Corte Contramarco: pág. 3

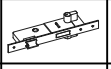
\* Medidas en milímetros

Dimensiones de Corte Premarco: pág. 4

Detalle de Accesorios				S/Travesaño	C/Travesaño
Ítem	Código	Descripción	Forma	Cantidad	Cantidad
Esc. de Armado	9821 8047	Esc. de Armado Marco E-83		2 Unidades	
	8425	Esc. de Armado Hoja E-70		2 Unidades	
	E-80	Escuadra Suplementaria Hoja de 47,9 mm		2 Unidades	
	8415	Esc. de Alineación Hoja E-62	-	2 Unidades	
Clip	8916	Clip Contravidrios T-96		s/m	s/m
Burlete Vidrio	8913	Burlete de Acristalamiento B-68		2A + 2H	4A + 2H
Cuña Vidrio	8209	Cuña Chica		2A + 2H	4A + 2H
	8210	Cuña Mediana			
	8211	Cuña Grande			
Burlete Hermetic.	8906	Burlete AEL europeo		1A + 2H	
	8914	Burlete Gabi III		1A + 2H	
Tapa Tornillo	8431	Tapa Cabeza de Tornillo T-100	-	8 Unidades	8 U. + 4 U. x Travesaño
Picaporte	8923	Manija Prima H-93		1 Unidad	
Cerradura	8958	Cerradura H-51 Kallay 2006		1 Unidad	
Bisagra	8233	Bisagra de 3 alas H-62		3 Unidades	
Felpa	8244	Felpa de 7x8 c/Fin Seal		2A	
Tornillos	8368	Tornillo Parker Parte I		8 Unidades	8 U. + 4 U. x Travesaño

s/m: según medida.

Accesorios Contramarco: pág. 3 Premarco: pág. 4

Vista

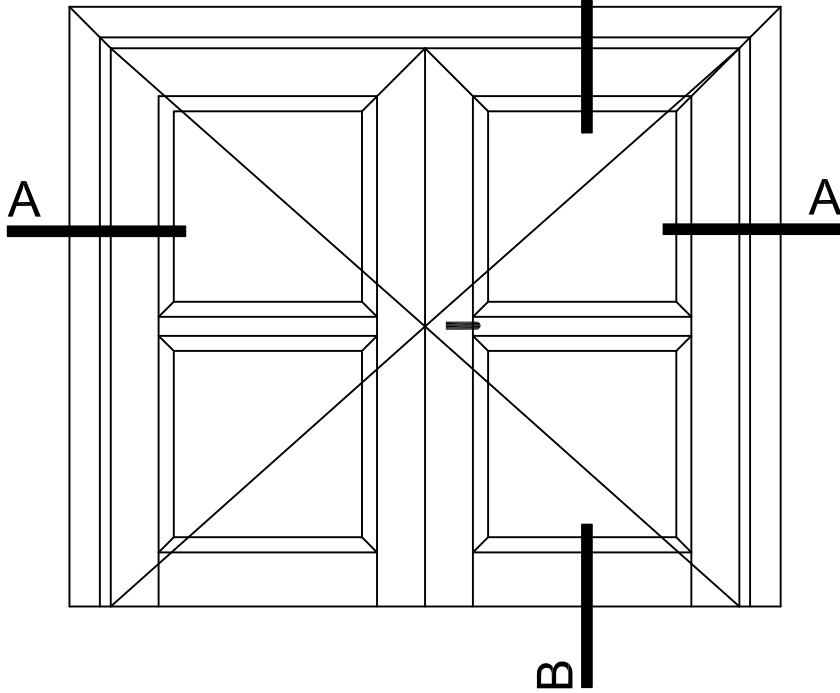

B-B Corte Vertical  
(Con Travesaño)

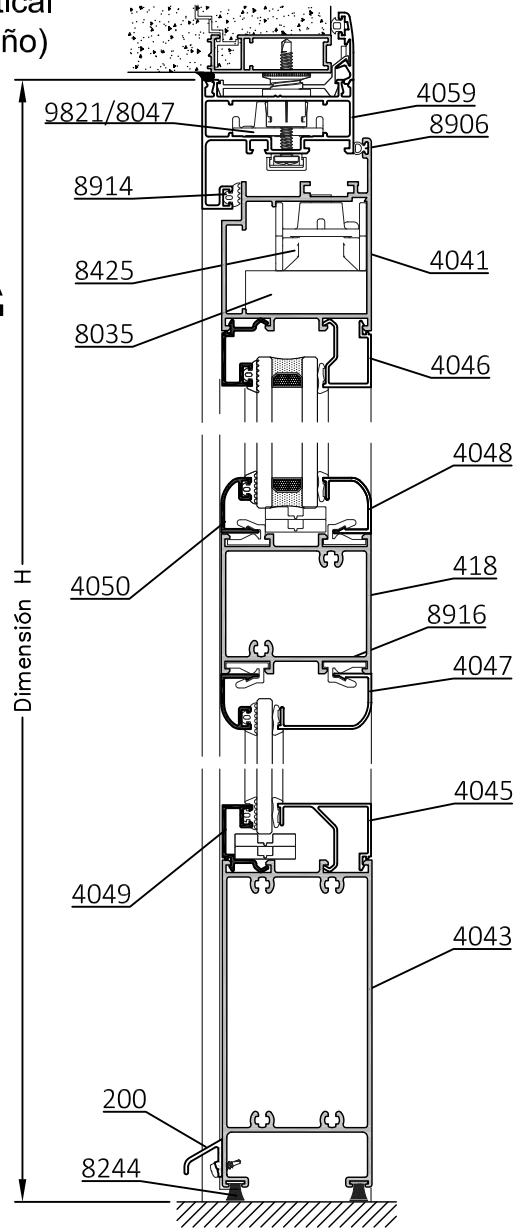



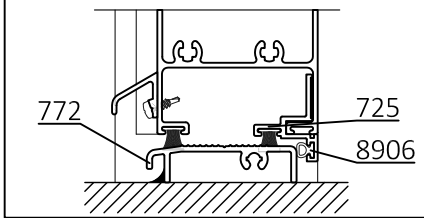

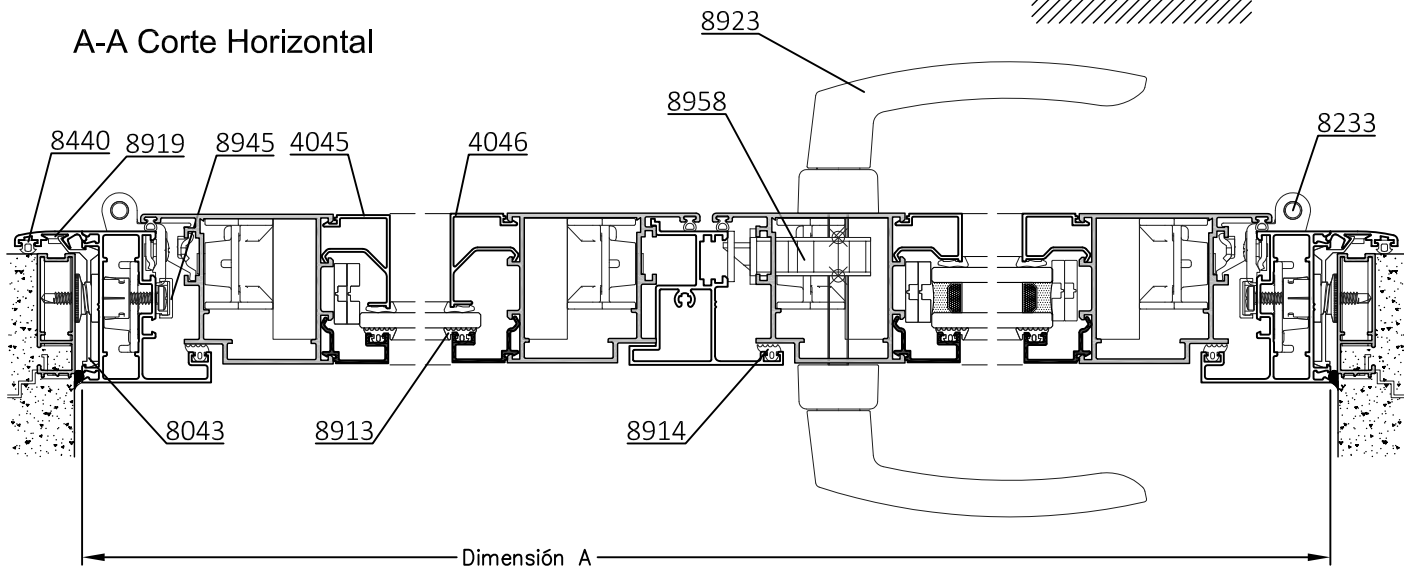

Opción de Zócalo Inferior  
con Umbral Transitable



A-A Corte Horizontal

















Dimensiones de Corte			sin Umbral Transitable				Con Umbral		
Código	Peso Kg/m	Forma	Función	Cant.	Largo	Corte	Cant.	Largo	Corte
4059	1,00		Marco	1	A	45° 45°	1	A	45° 45°
				2	H	45° 90°	2	H	45° 90°
4041	1,39		Hoja	2	A/2-26	45° 45°	2	A/2-26	45° 45°
				4	H-28	45° 90°	4	H-39	45° 90°
4042	1,40		Travesaño	1	A/2-180	90° 90°	1	A/2-180	90° 90°
4043	2,32		Zócalo	2	A/2-180	90° 90°	2	A/2-180	90° 90°
4044	1,04		Inversor	1	H-61	90° 90°	1	H-72	90° 90°
4047/4048/ 4050/051/052/053	-	-	Contrav int. con clip	2	A-201	45° 45°	2	A-201	45° 45°
				2	H-236	45° 45°	2	H-247	45° 45°
4045/4046	-	-	Contrav int. Recto	2	A-201	90° 90°	2	A-201	90° 90°
				2	H-280	90° 90°	2	H-291	90° 90°
4050	-	-	Contrav ext. Curvo	2	A-201	45° 45°	2	A-201	45° 45°
				2	H-236	45° 45°	2	H-247	45° 45°
4049	-	-	Contrav ext. Recto	2	A-201	90° 90°	2	A-201	90° 90°
				2	H-280	90° 90°	2	H-291	90° 90°
1060200	0,15		Bota agua	1	A-244	90° 90°	1	A-244	90° 90°

Dimensiones de Corte Contramarco: pág. 3

Dimensiones de Corte Premarco: pág. 4

\* Medidas en milímetros

Detalle de Accesorios				S/Travesaño	C/Travesaño
Ítem	Código	Descripción	Forma	Cantidad	Cantidad
Esc. de Armado	9821 8047	Esc. de Armado Marco E-83		2 Unidades	
	8425	Esc. de Armado Hoja E-70		4 Unidades	
	E-80	Escuadra Suplementaria Hoja de 47,9 mm		4 Unidades	
	8415	Esc. de Alineación Hoja E-62	-	4 Unidades	
Clip	8916	Clip Contravidrios T-96		s/m	s/m
Burlete Vidrio	8913	Burlete de Acristalamiento B-68		2A + 4H	4A + 4H
Cuña Vidrio	8209	Cuña Chica		2A + 4H	4A + 4H
	8210	Cuña Mediana			
	8211	Cuña Grande			
Burlete Hermetic.	8906	Burlete AEL europeo		1A + 3H	1A + 3H
	8914	Burlete Gabi III		1A + 3H	1A + 3H
Tapa Tornillo	8431	Tapa Cabeza de Tornillo T-100	-	16 Unidades	16 U. + 8 U. x Travesaño
Picaporte	8923	Manija Prima H-93		1 Unidad	1 Unidad
Cerradura	8958	Cerradura H-51 Kallay 2006		1 Unidad	1 Unidad
Bisagra	8233	Bisagra de 3 alas H-62		6 Unidades	6 Unidades
Felpa	8244	Felpa de 7x8		2A	2A
Tornillos	8368	Tornillo Parker Parte I		16 Unidades	16 U. + 8 U. x Travesaño
Pasador	9124	Pasador H-42 Giesse		2 Unidad	2 Unidad
	9217	Pasador Totem 18mm.			
Tapón Inversor	9741	Tapón Inversor de Hoja de puerta T-120		1 Par	1 Par

s/m: según medida.

Tolerancia en Peso +/- 10%

Accesorios Contramarco: pág. 3 Premarco: pág. 4

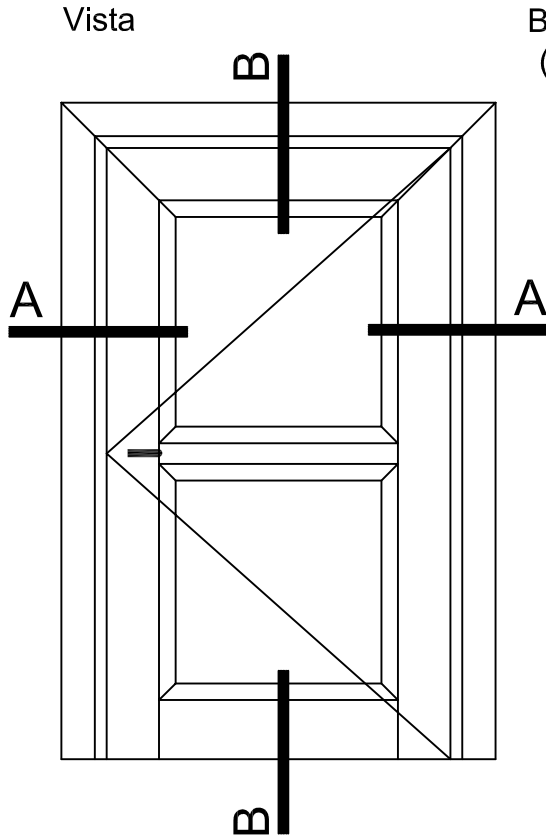

B-B Corte Vertical  
(Con Travesaño)

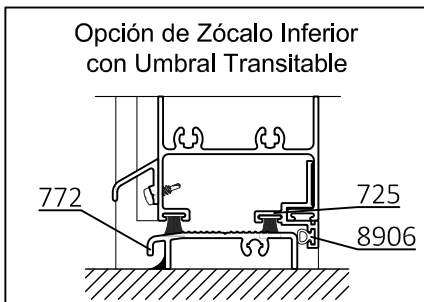
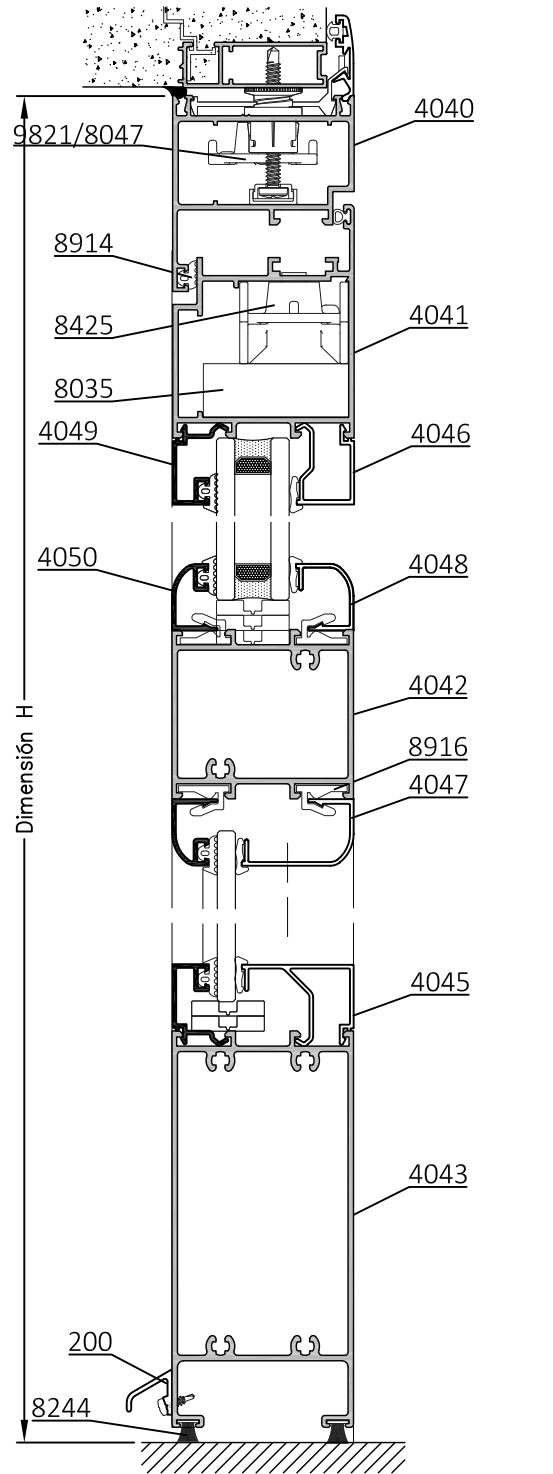

A-A Corte Horizontal

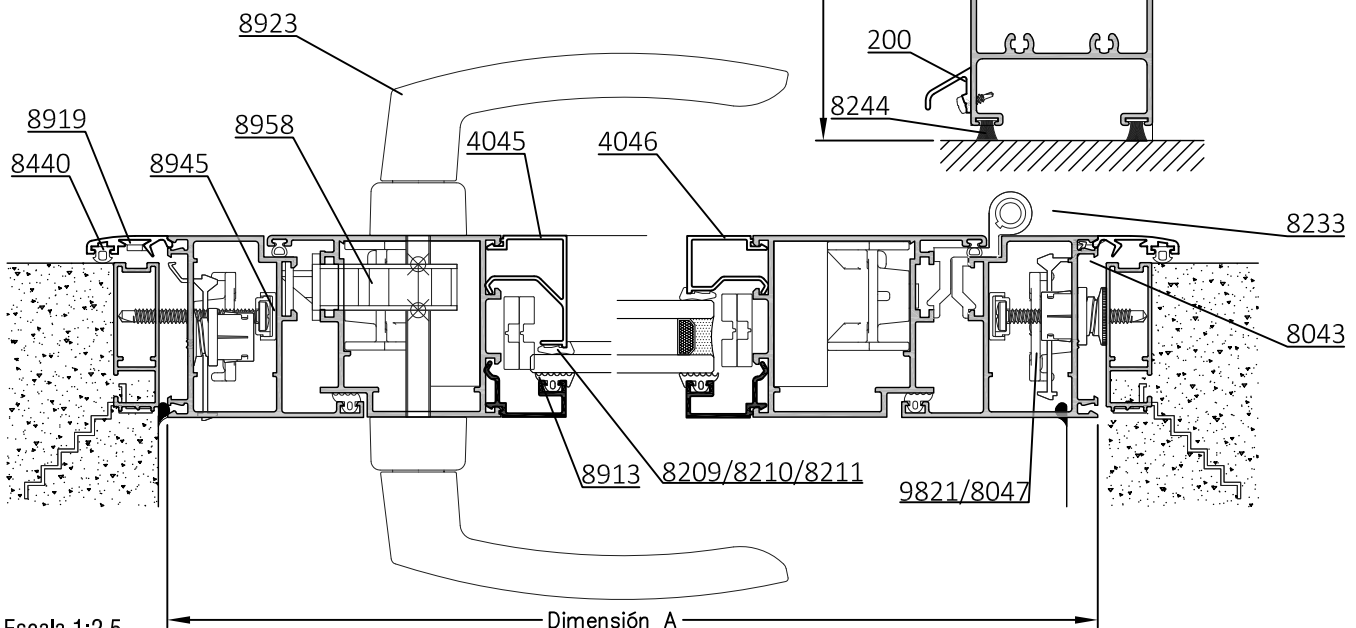





Escala 1:2.5

Tolerancia en Peso +/- 10%

20

09 - 2024













NIZA

Dimensiones de Corte			sin Umbral Transitable				Con Umbral		
Código	Peso Kg/m	Forma	Función	Cant.	Largo	Corte	Cant.	Largo	Corte
4040	1,00		Marco	1	A	45° 45°	1	A	45° 45°
				2	H	45° 90°	2	H	45° 90°
4041	1,39		Hoja	1	A-74	45° 45°	1	A-74	45° 45°
				2	H-42	45° 90°	2	H-53	45° 90°
4043	2,32		Zócalo	1	A-228	90° 90°	1	A-201	90° 90°
4042	1,40		Travesaño	1	A-228	90° 90°	1	A-228	90° 90°
4047/4048/ 4050/051/052/053	-	-	Contrav int. con clip	2	A-201	45° 45°	2	A-201	45° 45°
				2	H-236	45° 45°	2	H-247	45° 45°
4045/4046	-	-	Contrav int. Recto	2	A-201	90° 90°	2	A-201	90° 90°
				2	H-280	90° 90°	2	H-291	90° 90°
4050	-	-	Contrav ext. Curvo	2	A-201	45° 45°	2	A-201	45° 45°
				2	H-236	45° 45°	2	H-247	45° 45°
4049	-	-	Contrav ext. Recto	2	A-201	90° 90°	2	A-201	90° 90°
				2	H-280	90° 90°	2	H-291	90° 90°
1060200	0,15		Bota agua	1	A-244	90° 90°	1	A-244	90° 90°

Dimensiones de Corte Contramarco: pág. 3

Dimensiones de Corte Premarco: pág. 4

\* Medidas en milímetros

Detalle de Accesorios				S/Travesaño	C/Travesaño
Ítem	Código	Descripción	Forma	Cantidad	Cantidad
Esc. de Armado	8425	Esc. de Armado Marco y Hoja E-70		4 Unidades	
	E-80	Escuadra Suplementaria Hoja de 47,9 mm		2 Unidades	
	8415	Esc. de Alineación Hoja E-62	-	2 Unidades	
Clip	8916	Clip Contravidrios T-96		s/m	s/m
Burlete Vidrio	8913	Burlete de Acristamiento B-68		2A + 2H	4A + 2H
Cuña Vidrio	8209	Cuña Chica		2A + 2H	
	8210	Cuña Mediana			
	8211	Cuña Grande			
Burlete Hermetic.	8906	Burlete AEL europeo		1A + 2H	
	8914	Burlete Gabi III		1A + 2H	
Tapa Tornillo	8431	Tapa Cabeza de Tornillo T-100	-	8 Unidades	8 U. + 4 U. x Travesaño
Picaporte	8923	Manija Prima H-93		1 Unidad	
Cerradura	8958	Cerradura H-51 Kallay 2006		1 Unidad	
Bisagra	9260	Bisagra Celera H-81 2 alas		3 Unidades	
	9216	Bisagra H-82 3 Alas			
	9257	Bisagra Domina 2 alas H-103			
Felpa	8244	Felpa de 7x8 c/Fin Seal		2A	
Tornillos	8368	Tornillo Parker Parte I		8 Unidades	8 U. + 4 U. x Travesaño

s/m: según medida.

Accesorios Contramarco: pág. 3 Premarco: pág. 4

Tolerancia en Peso +/- 10%

21

09 - 2024

NIZA

Vista

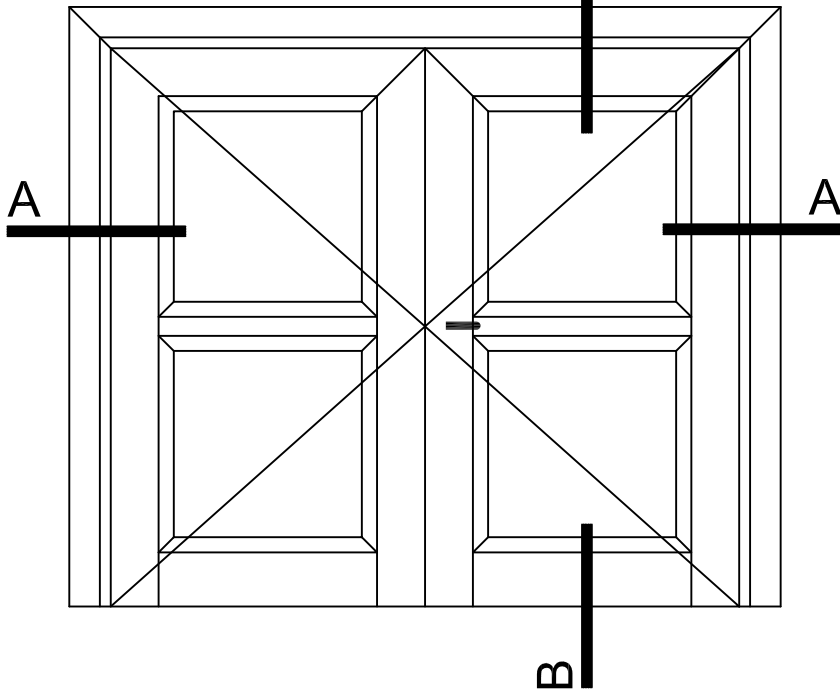

B-B Corte Vertical  
(Con Travesaño)

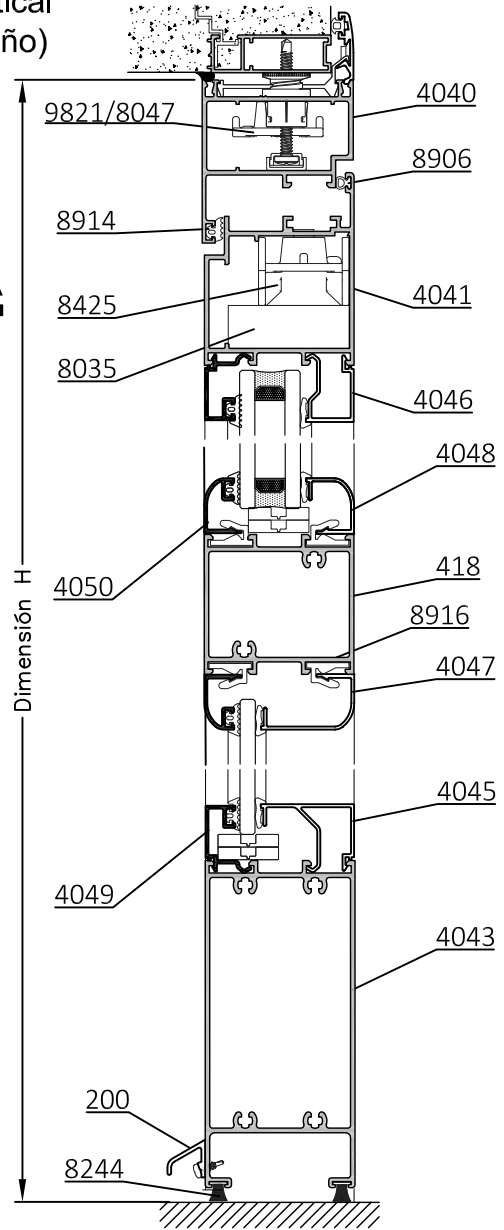



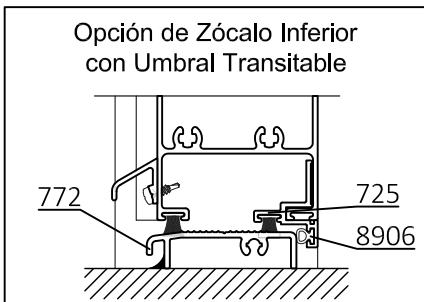

Opción de Zócalo Inferior  
con Umbral Transitable

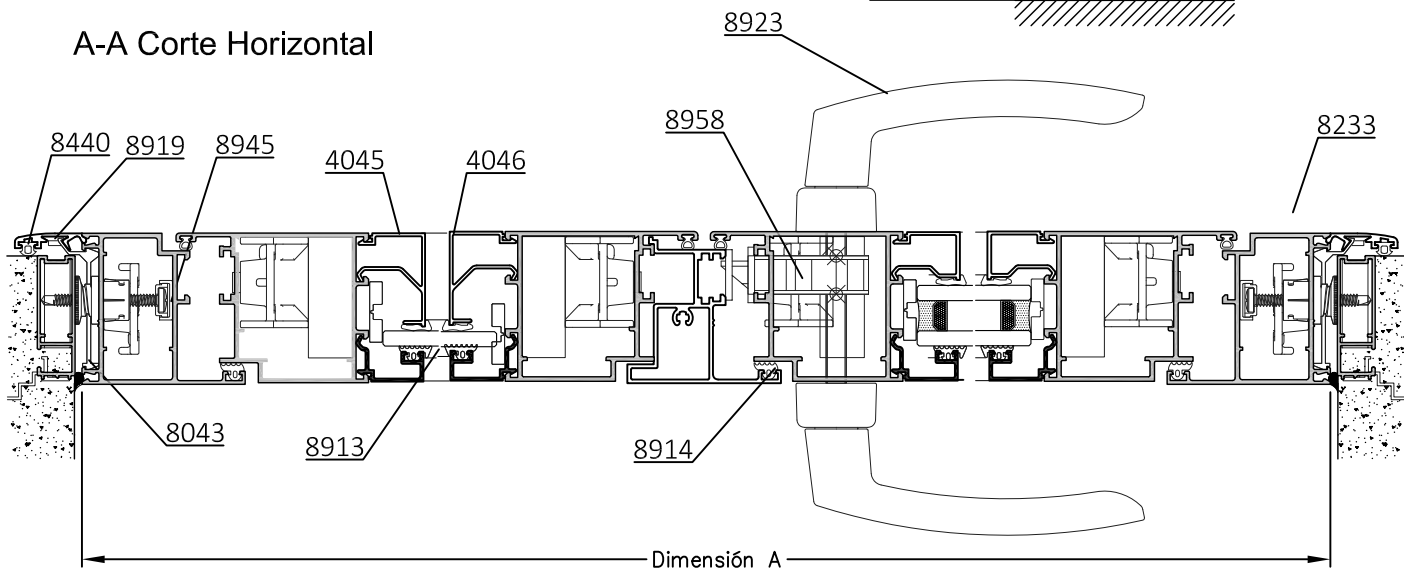

A-A Corte Horizontal

















Dimensiones de Corte			sin Umbral Transitable				Con Umbral		
Código	Peso Kg/m	Forma	Función	Cant.	Largo	Corte	Cant.	Largo	Corte
4040	1,00		Marco	1	A	45° 45°	1	A	45° 45°
				2	H	45° 90°	2	H	45° 90°
4041	1,39		Hoja	2	A/2-39	45° 45°	2	A/2-39	45° 45°
				4	H-42	45° 90°	4	H-53	45° 90°
4043	2,32		Zócalo	2	A/2-194	90° 90°	2	A/2-194	90° 90°
4044	1,04		Inversor	1	H-75	90° 90°	1	H-86	90° 90°
4047/4048/ 4050/051/052/053	-	-	Contrav int. con clip	2	A-201	45° 45°	2	A-201	45° 45°
				2	H-236	45° 45°	2	H-247	45° 45°
4045/4046	-	-	Contrav int. Recto	2	A-201	90° 90°	2	A-201	90° 90°
				2	H-280	90° 90°	2	H-291	90° 90°
4050	-	-	Contrav ext. Curvo	2	A-201	45° 45°	2	A-201	45° 45°
				2	H-236	45° 45°	2	H-247	45° 45°
4049	-	-	Contrav ext. Recto	2	A-201	90° 90°	2	A-201	90° 90°
				2	H-280	90° 90°	2	H-291	90° 90°
1060200	0,15		Bota agua	1	A-244	90° 90°	1	A-244	90° 90°

Dimensiones de Corte Contramarco: pág. 3

Dimensiones de Corte Premarco: pág. 4

\* Medidas en milímetros

Detalle de Accesorios				S/Travesaño	C/Travesaño
Ítem	Código	Descripción	Forma	Cantidad	Cantidad
Esc. de Armado	8425	Esc. de Armado Marco y Hoja E-70		6 Unidades	
	E-80	Escuadra Suplementaria Hoja de 47,9 mm		4 Unidades	
	8415	Esc. de Alineación Hoja E-62	-	4 Unidades	
Clip	8916	Clip Contravidrios T-96		s/m	s/m
Burlete Vidrio	8913	Burlete de Acristalamiento B-68		2A + 4H	4A + 4H
Cuña Vidrio	8209	Cuña Chica		2A + 4H	4A + 4H
	8210	Cuña Mediana			
	8211	Cuña Grande			
Burlete Hermetic.	8906	Burlete AEL europeo		1A + 3H	1A + 3H
	8914	Burlete Gabi III		1A + 3H	1A + 3H
Tapa Tornillo	8431	Tapa Cabeza de Tornillo T-100	-	16 Unidades	16 U. + 8 U. x Travesaño
Picaporte	8923	Manija Prima H-93		1 Unidad	1 Unidad
Cerradura	8958	Cerradura H-51 Kallay 2006		1 Unidad	1 Unidad
Bisagra	9260	Bisagra Celera H-81 2 alas		6 Unidades	6 Unidades
	9216	Bisagra H-82 3 alas			
	9258	Bisagra Domina 3 alas H-104			
Felpa	8244	Felpa de 7x8 c/Fin Seal		2A	2A
Tornillos	8368	Tornillo Parker Parte I		16 Unidades	16 U. + 8 U. x Travesaño
Pasador	9124	Pasador H-42 Giesse		2 Unidad	2 Unidad
	9217	Pasador Totem 18mm.			
Tapón Inversor	9741	Tapón Inversor de Hoja de puerta T-120		1 Par	1 Par

s/m: según medida.

Accesorios Contramarco: pág. 3 Premarco: pág. 4

Tolerancia en Peso +/- 10%

23

09 - 2024

NIZA

Vista

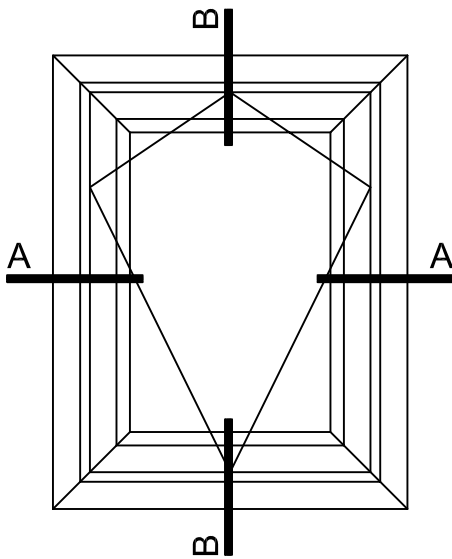

B-B Corte Vertical

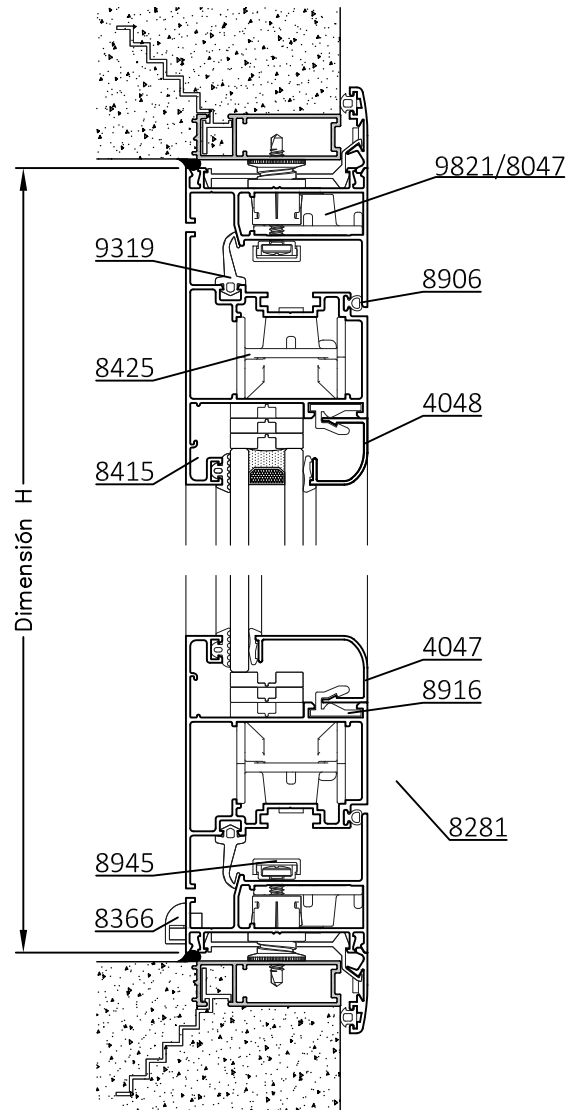

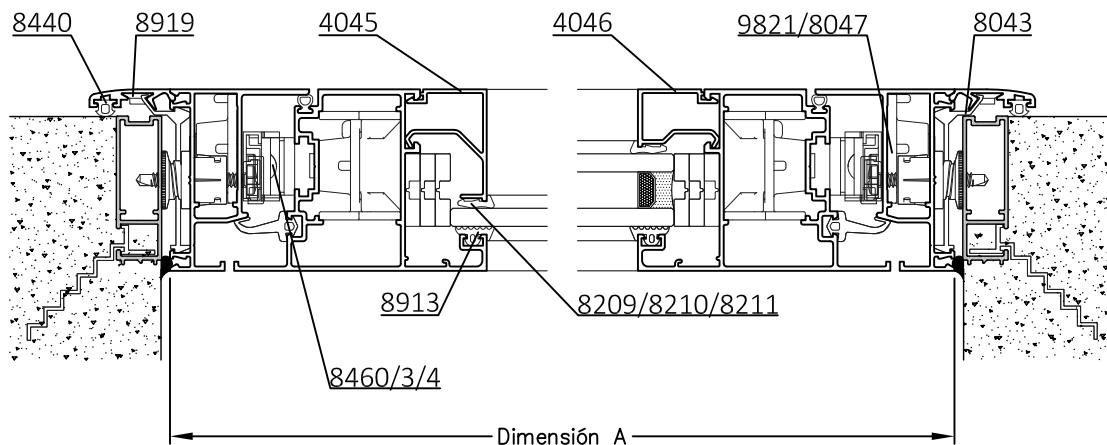

A-A Corte Horizontal



Escala 1:2.5

Tolerancia en Peso +/- 10%













Dimensiones de Corte						
Código	Peso Kg/m	Forma	Función	Cant.	Largo	Corte
1110734	0,79		Marco	2	A	45° 45°
				2	H	45° 45°
1110735	1,25		Hoja	2	A-43	45° 45°
				2	H-43	45° 45°
4047/4048/ 4050/051/052/053	-	-	Contrav. con clip	2	A-166	45° 45°
				2	H-166	45° 45°
4045/4046/ 4049	-	-	Contrav. Recto	2	A-166	90° 90°
				2	H-210	90° 90°

Dimensiones de Corte Contramarco: pág. 3

\* Medidas en milímetros

Dimensiones de Corte Premarco: pág. 4

Detalle de Accesorios				
Ítem	Código	Descripción	Forma	Cantidad
Esc. de Armado	9821 8047	Esc. de Armado Marco E-83		4 Unidades
	8425	Esc. de Armado Hoja E-70		4 Unidades
	8415	Esc. de Alineación Hoja E-62	-	4 Unidades
Clip	8916	Clip Contravidrios T-96		s/m
Cuña Vidrio	8209	Cuña Chica		2A + 2H
	8210	Cuña Mediana		
	8211	Cuña Grande		
Burlete Vidrio	8913	Burlete de Acristalamiento B-68		2A + 2H
Burlete Hermetic.	8906	Burlete AEL europeo		2A + 2H
Burlete Hermetic.	9319	Burlete Hermeticidad Exterior (B-74)		2A + 2H
Aldaba (a) (de aplicar)	8281	Aldaba CP25		1 Unidad (a)
	8475	Aldaba Mónaco		
Tijera	8464	Tijera de Aºº 259 mm. H(*) 750mm - 50 kg.		1 Par
	8460	Tijera de Aºº 412 mm. H(*) 1100mm-70 kg.		
	8463	Tijera de Aºº 558 mm. H(*) 1350mm-74 kg.		
	8471	Tijera de Aºº 660 mm. H(*) 2000mm-120 kg.		
	8411	Tijera de Aºº 262 mm. H(*) 750mm - 37 kg.		
	8412	Tijera de Aºº 415 mm. H(*) 1100mm-55 kg.		
	8413	Tijera de Aºº 567 mm. H(*) 1350mm-75 kg.		
8414	Tijera de Aºº 660 mm. H(*) 2000mm-100 kg.			

s/m: según medida.

Accesorios Contramarco: pág. 3 Premarco: pág. 4

(a): En hojas de 900 mm o más de ancho se aconseja utilizar 2 aldabas de cierre por hoja.

H(\*): Altura de Hoja.

Tijeras Cod.8460/8463/8464/8471 marca Cotsword.





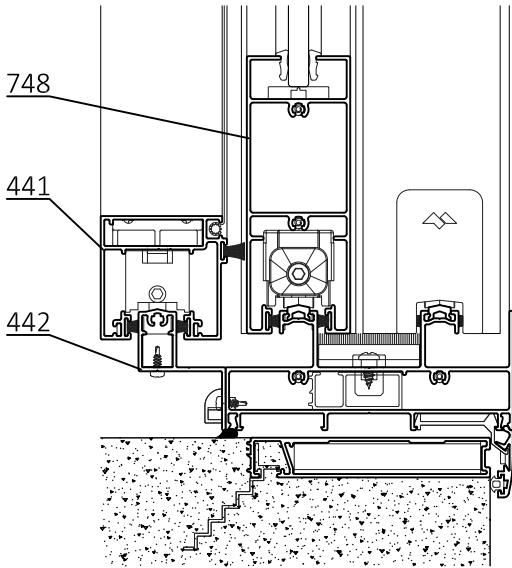
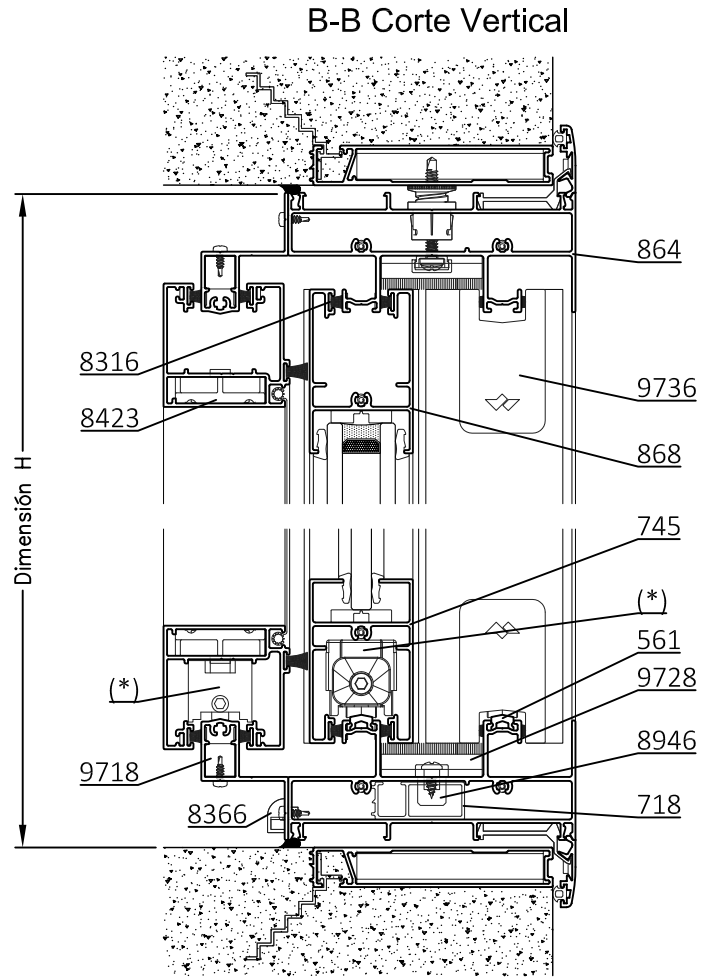
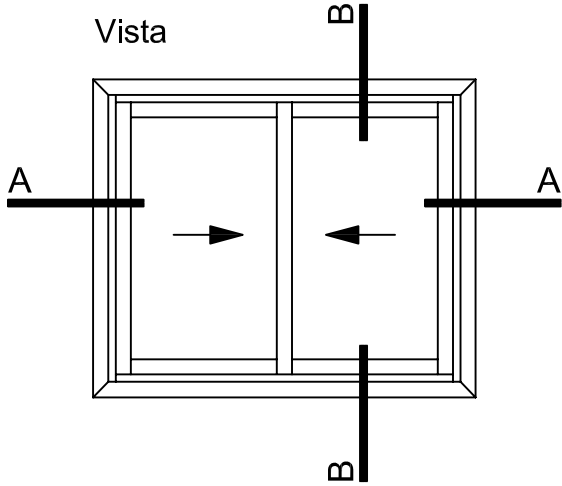

Tijeras Cod.8411/8412/8413/8414 marca Storm.

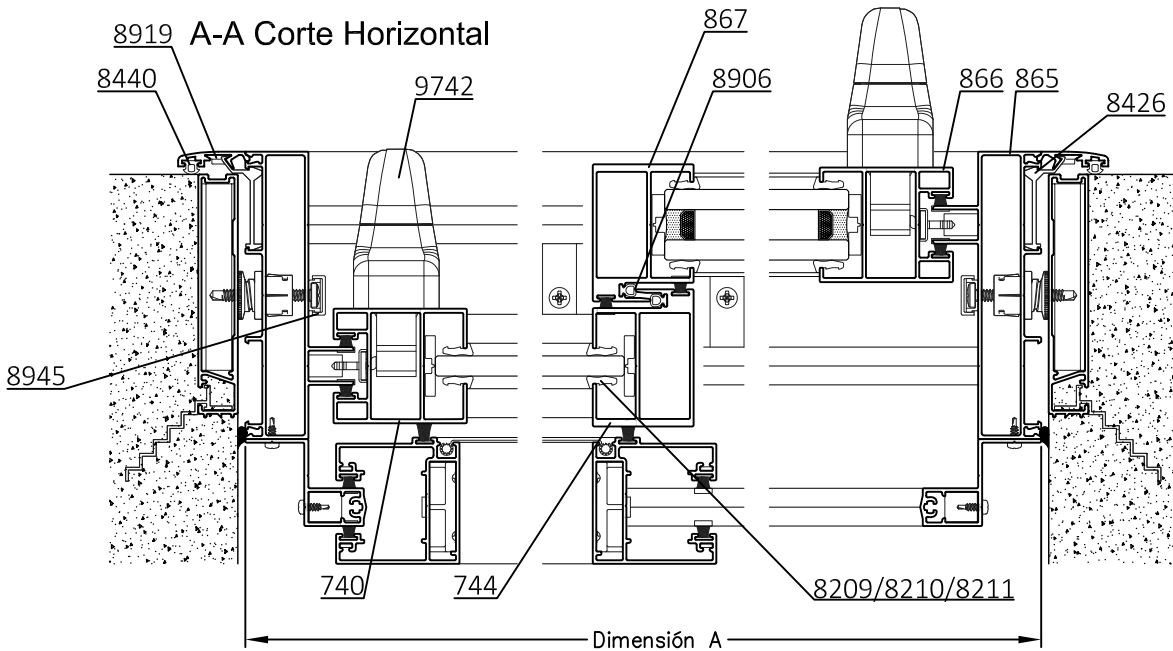
Nota: En hojas de 1200 mm o más de alto se aconseja utilizar un limitador de apertura (Cód. 8481)

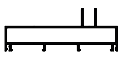
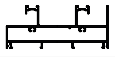

(\*) ver tabla de ruedas

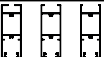













Dimensiones de Corte				Ventana Corrediza			Puerta Corrediza		
Código	Peso Kg/m	Forma	Función	Cant.	Largo	Corte	Cant.	Largo	Corte
1110865	1,29		Jamba	2	H	90° 90°	2	H	90° 90°
1110864	1,79		Umbral Dintel	2	A-50	90° 90°	2	A-50	90° 90°
1060561	0,09		Guía Inf. Marco	2	A-50	90° 90°	2	A-50	90° 90°
1110740 / 1110716 1110866	1,10 / 1,04 1,02		Parante Lateral	2	H-78	90° 90°	2	H-78	90° 90°
1110744 / 1110717 1110867	1,21 / 1,16 1,13		Parante Central	2	H-78	90° 90°	2	H-78	90° 90°
1110745 / 1110724 1110868	0,98 / 0,91 0,89		Cabezal Zócalo	4	A/2-30	90° 90°	2	A/2-30	90° 90°
1110748 / 1110728 1110869	1,54 / 1,49 1,47		Zócalo Alto	-	-	-	2	A/2-30	90° 90°
1110442	0,51		Guía mosq.	2	A	45° 45°	2	A	45° 45°
				2	H	45° 45°	2	H	45° 45°
1110441	1,02		Hoja mosq.	2	A/2-4	45° 45°	2	A/2-4	45° 45°
				2	H-78	45° 45°	2	H-78	45° 45°

Dimensiones de Corte Contramarco: pág. 3

\* Medidas en milímetros

Dimensiones de Corte Premarco: pág. 4

Detalle de Accesorios				V. Corrediza	P. Corrediza
Ítem	Código	Descripción	Forma	Cantidad	Cantidad
Escuadra armado	8423	Escuadra armado mosquitero E-69		4 Unidades	4 Unidades
	9718	Escuadra guía mosquitero		4 Unidades	4 Unidades
Tornillo	8368	Tornillo Parker Parte I		16 Unidades	20 Unidades
Cuña Vidrio	8209	Cuña Chica		4A + 8H	4A + 8H
	8210	Cuña Mediana			
	8211	Cuña Grande			
Burlete Hermetic. Felpa	8906	Burlete AEL europeo parante central		2H	2H
	8316	Felpa de Polipropileno 7 x 6 mm.		6A + 12H	6A + 12H
Cierre Multipunto	9742	Cierre lateral multipunto hoja 90° H-132		2 Unidades	2 Unidades
Rodamientos	9974	Rueda simple JN 80 Kg hoja R-46		4 Unidades	-
	8125	Rueda simple Carrera 100 Kg hoja R-46			
	8140	Rueda simple Pabose 150 Kg hoja R-46			
	9975	Rueda doble JN 180 Kg hoja R-47		-	4 Unidades
	8126	Rueda doble Carrera 200 Kg hoja R-47			
	8141	Rueda doble Pabose 300 Kg hoja R-47			
	8932	Rueda simple Torino 40 kg hoja p/ mosqu.	-	2 Unidades	2 Unidades
Tope Central y Lat	9736	Tope Parante Central T-156		4 Unidades	4 Unidades
	9737	Tope Parante Lateral T-157			
Cruce de Hoja	9728	Cruce de Hoja hoja 90° T-158		2 Unidades	2 Unidades
Boca Desagüe	8946	Boca Desagüe T-94 T-130		s/m	s/m
Tapa Desagüe	8366	Tapa Desagüe T-69 T-131		2 Unidades	2 Unidades
Junta estanqueidad	9732	Junta de estanqu. marco corr. 2 guías T-162		2 Pares	2 Pares

s/m: según medida.

Accesorios Contramarco: pág. 3 Premarco: pág. 4

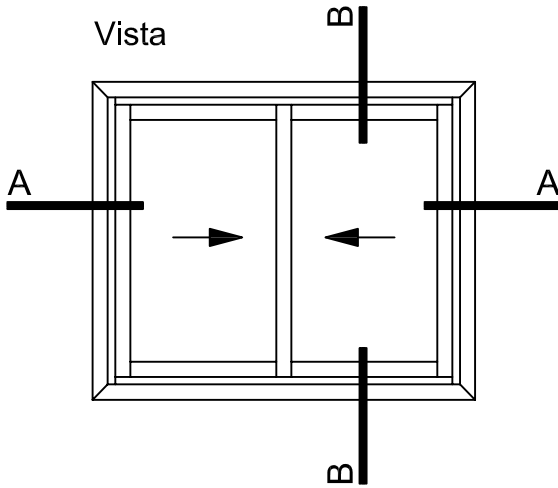



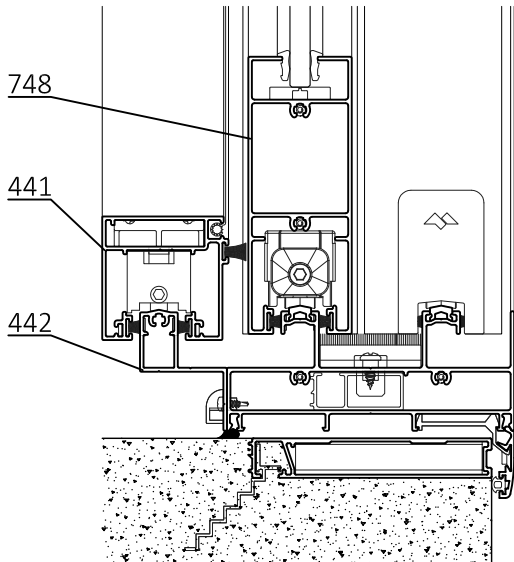
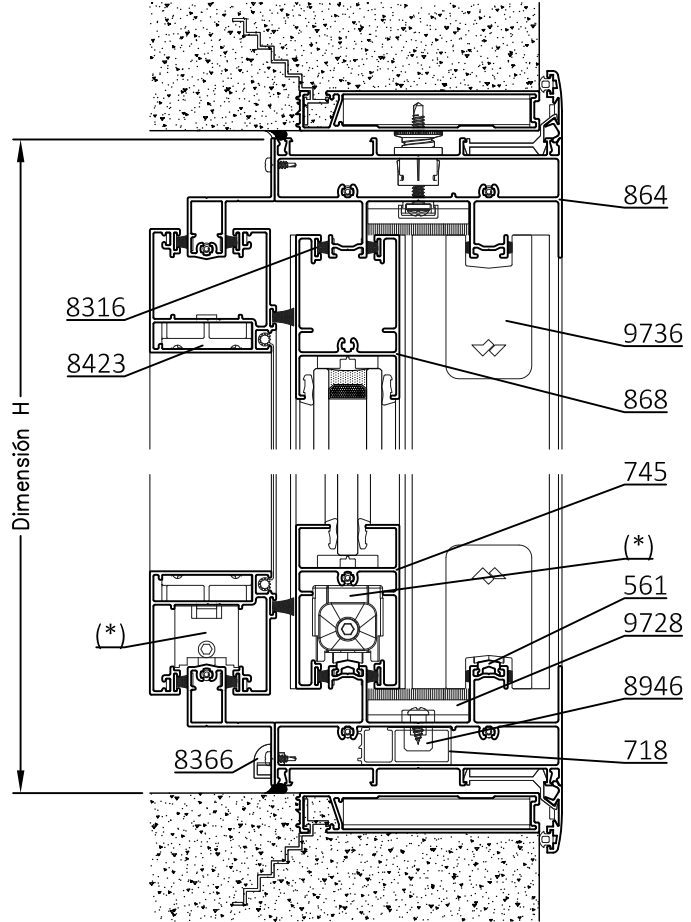



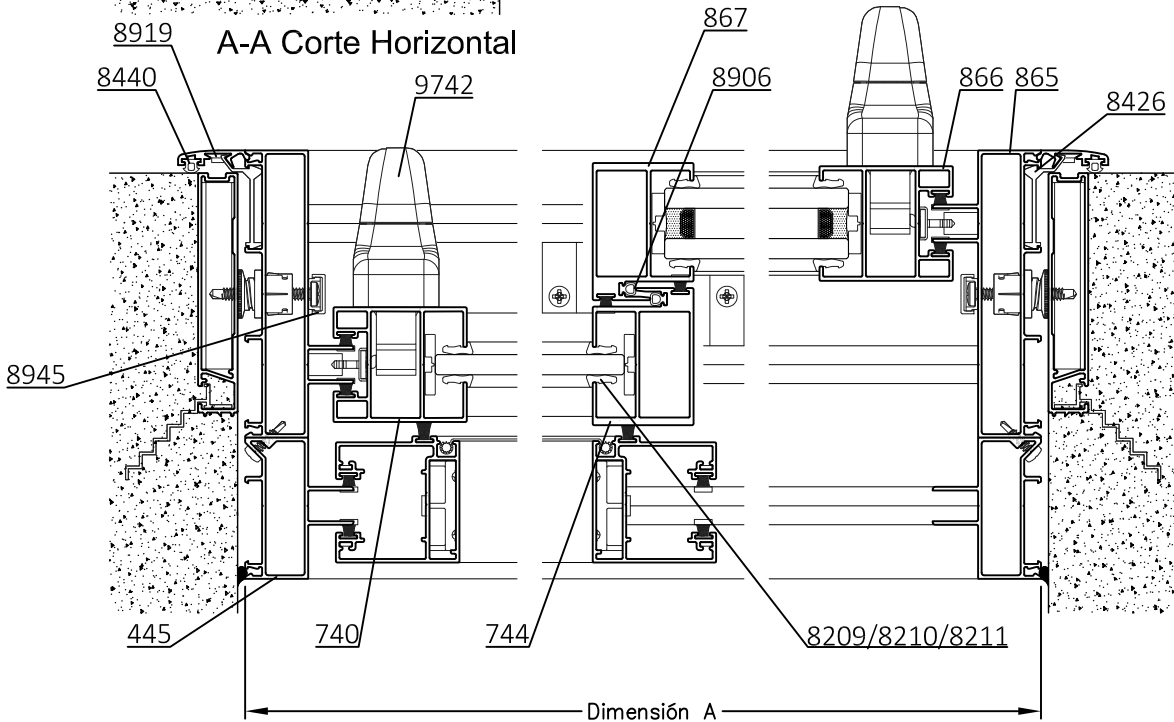

B-B Corte Vertical

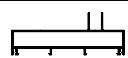
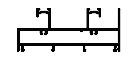

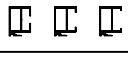
(\* ver tabla de ruedas

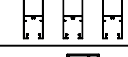
A-A Corte Horizontal

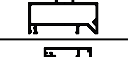













Dimensiones de Corte				Ventana Corrediza			Puerta Corrediza		
Código	Peso Kg/m	Forma	Función	Cant.	Largo	Corte	Cant.	Largo	Corte
1110865	1,29		Jamba	2	H	90° 90°	2	H	90° 90°
1110864	1,79		Umbral Dintel	2	A-50	90° 90°	2	A-50	90° 90°
1060561	0,09		Guía Inf. Marco	2	A-50	90° 90°	2	A-50	90° 90°
1110740 / 1110716 1110866	1,10 / 1,04 1,02		Parante Lateral	2	H-78	90° 90°	2	H-78	90° 90°
1110744 / 1110717 1110867	1,21 / 1,16 1,13		Parante Central	2	H-78	90° 90°	2	H-78	90° 90°
1110745 / 1110724 1110868	0,98 / 0,91 0,89		Cabezal Zócalo	4	A/2-30	90° 90°	2	A/2-30	90° 90°
1110748 / 1110728 1110869	1,54 / 1,49 1,47		Zócalo Alto	-	-	-	2	A/2-30	90° 90°
1110442	0,51		Guía mosq.	2	A-50	90° 90°	2	A-50	90° 90°
1110445	0,82		Guía mosq.	2	H	90° 90°	2	H	90° 90°
1110441	1,02		Hoja mosq.	2	A/2-4	45° 45°	2	A/2-4	45° 45°
				2	H-78	45° 45°	2	H-78	45° 45°

Dimensiones de Corte Contramarco: pág.3

\* Medidas en milímetros

Dimensiones de Corte Premarco: pág. 4

Detalle de Accesorios				V. Corrediza	P. Corrediza
Ítem	Código	Descripción	Forma	Cantidad	Cantidad
Escuadra armado	8423	Escuadra armado mosquitero E-69		4 Unidades	4 Unidades
Tornillo	8368	Tornillo Parker Parte I		20 Unidades	24 Unidades
Cuña Vidrio	8209	Cuña Chica		4A + 8H	4A + 8H
	8210	Cuña Mediana			
	8211	Cuña Grande			
Burlete Hermetic.	8906	Burlete AEL europeo parante central		2H	2H
Felpa	8316	Felpa de Polipropileno 7 x 6 mm.		6A + 12H	6A + 12H
Cierre Multipunto	9742	Cierre lateral multipunto hoja 90° H-132		2 Unidades	2 Unidades
Rodamientos	9974	Rueda simple JN 80 Kg hoja R-46		4 Unidades	-
	8125	Rueda simple Carrera 100 Kg hoja R-46			
	8140	Rueda simple Pabose 150 Kg hoja R-46			
	9975	Rueda doble JN 180 Kg hoja R-47		-	4 Unidades
	8126	Rueda doble Carrera 200 Kg hoja R-47			
	8141	Rueda doble Pabose 300 Kg hoja R-47			
Tope Central y Lat	8932	Rueda simple Torino 40 kg hoja p/ mosqu.	-	2 Unidades	2 Unidades
	9736	Tope Parante Central T-156		4 Unidades	4 Unidades
9737	Tope Parante Lateral T-157				
Cruce de Hoja	9728	Cruce de Hoja hoja 90° T-158		2 Unidades	2 Unidades
Boca Desagüe	8946	Boca Desagüe T-94 T-130		s/m	s/m
Tapa Desagüe	8366	Tapa Desagüe T-69 T-131		2 Unidades	2 Unidades
Junta estanqueidad	9732	Junta de estanqu. marco corr. 2 guías T-162		2 Pares	2 Pares

s/m: según medida.



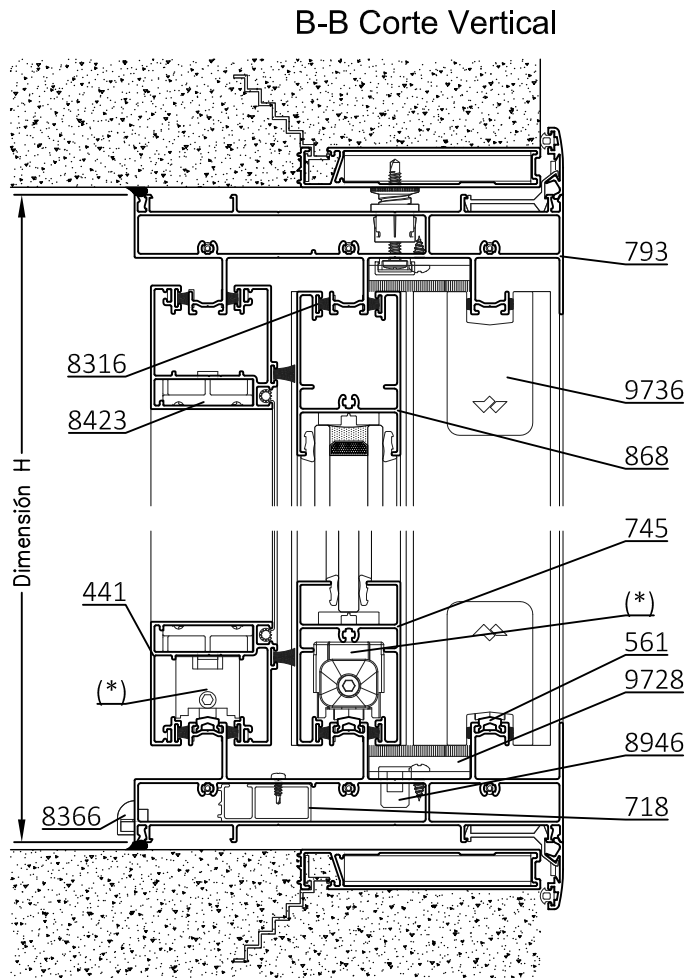
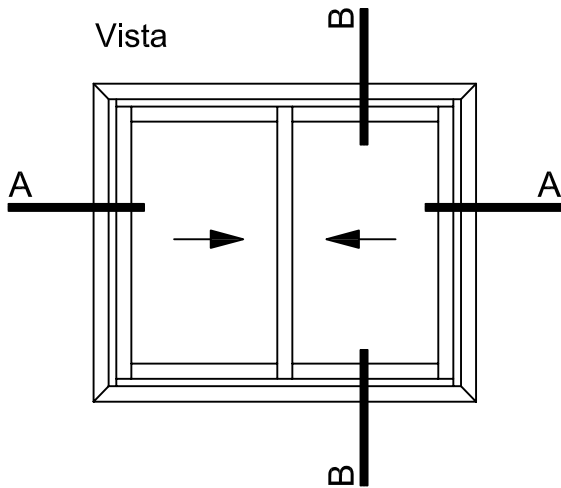



Accesorios Contramarco: pág. 3 Premarco: pág. 4

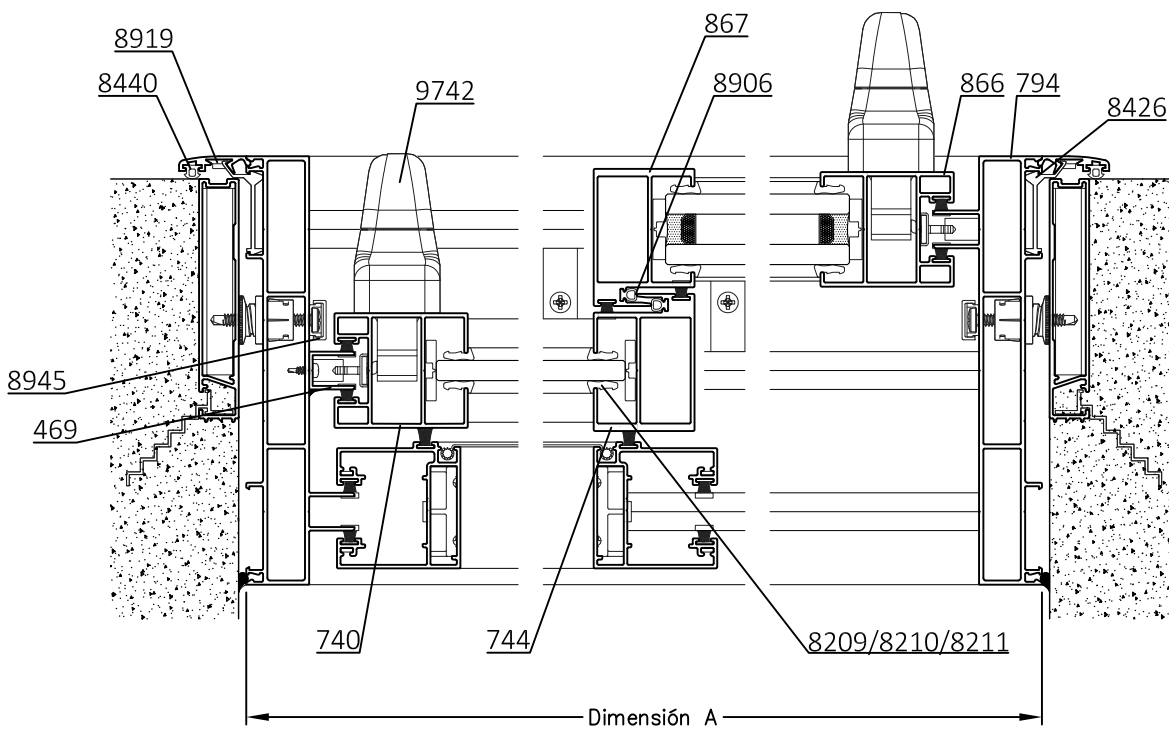

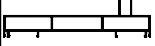
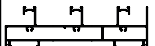
A-A Corte Horizontal

(\* ) ver tabla de ruedas

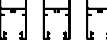
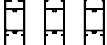













Dimensiones de Corte				Ventana Corrediza			Puerta Corrediza		
Código	Peso Kg/m	Forma	Función	Cant.	Largo	Corte	Cant.	Largo	Corte
1110794	2,14		Jamba	2	H	90° 90°	2	H	90° 90°
1110793	2,54		Umbral Dintel	2	A-50	90° 90°	2	A-50	90° 90°
1060561	0,09		Guía Inf. Marco	3	A-50	90° 90°	2	A-50	90° 90°
1110469	0,18		U Jamba	1	H-95	90° 90°	1	H-95	90° 90°
1110740 / 1110716 1110866	1,10 / 1,04 1,02		Parante Lateral	2	H-78	90° 90°	2	H-78	90° 90°
1110744 / 1110717 1110867	1,21 / 1,16 1,13		Parante Central	2	H-78	90° 90°	2	H-78	90° 90°
1110745 / 1110724 1110868	0,98 / 0,91 0,89		Cabezal Zócalo	4	A/2-30	90° 90°	2	A/2-30	90° 90°
1110748 / 1110728 1110869	1,54 / 1,49 1,47		Zócalo Alto	-	-	-	2	A/2-30	90° 90°
1110441	1,02		Hoja mosq.	2	A/2-4	45° 45°	2	A/2-4	45° 45°
				2	H-78	45° 45°	2	H-78	45° 45°

Dimensiones de Corte Contramarco: pág. 3

\* Medidas en milímetros

Dimensiones de Corte Premarco: pág. 4

Detalle de Accesorios				V. Corrediza	P. Corrediza
Ítem	Código	Descripción	Forma	Cantidad	Cantidad
Escuadra armado	8423	Escuadra armado mosquitero E-69		4 Unidades	4 Unidades
Tornillo	8368	Tornillo Parker Parte I		20 Unidades	24 Unidades
Cuña Vidrio	8209	Cuña Chica		4A + 8H	4A + 8H
	8210	Cuña Mediana			
	8211	Cuña Grande			
Burlete Hermetic.	8906	Burlete AEL europeo parante central		2H	2H
Felpa	8316	Felpa de Polipropileno 7 x 6 mm.		6A + 12H	6A + 12H
Cierre Multipunto	9742	Cierre lateral multipunto hoja 90° H-132		2 Unidades	2 Unidades
Rodamientos	9974	Rueda simple JN 80 Kg hoja R-46		4 Unidades	-
	8125	Rueda simple Carrera 100 Kg hoja R-46			
	8140	Rueda simple Pabose 150 Kg hoja R-46			
	9975	Rueda doble JN 180 Kg hoja R-47		-	4 Unidades
	8126	Rueda doble Carrera 200 Kg hoja R-47			
	8141	Rueda doble Pabose 300 Kg hoja R-47			
	8932	Rueda simple Torino 40 kg hoja p/ mosqu.	-	2 Unidades	2 Unidades
Tope Central y Lat	9736	Tope Parante Central T-156		4 Unidades	4 Unidades
	9737	Tope Parante Lateral T-157			
Cruce de Hoja	9728	Cruce de Hoja hoja 90° T-158		2 Unidades	2 Unidades
Boca Desagüe	8946	Boca Desagüe T-94 T-130		s/m	s/m
Tapa Desagüe	8366	Tapa Desagüe T-69 T-131		2 Unidades	2 Unidades
Junta estanqueidad	9733	Junta de estanqu. marco corr. 3 guías T-163		2 Pares	2 Pares

s/m: según medida.

Accesorios Contramarco: pág. 3 Premarco: pág. 4



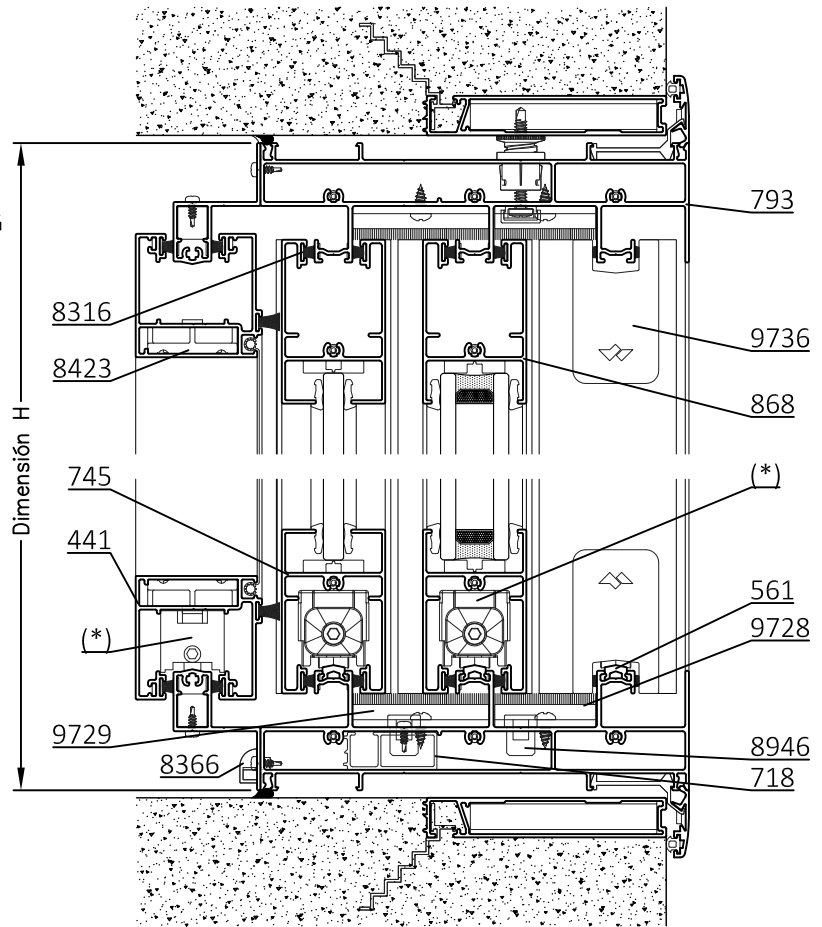
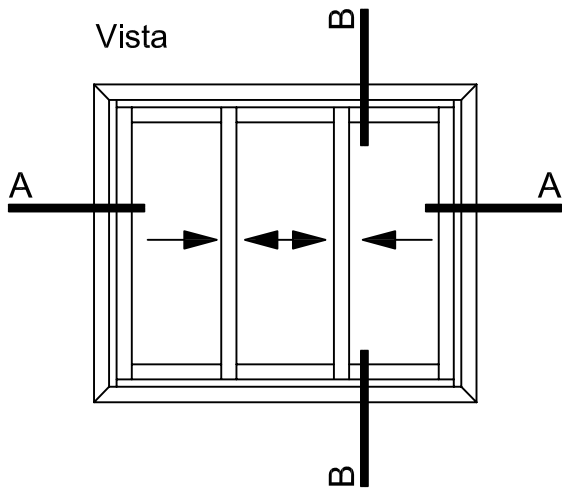



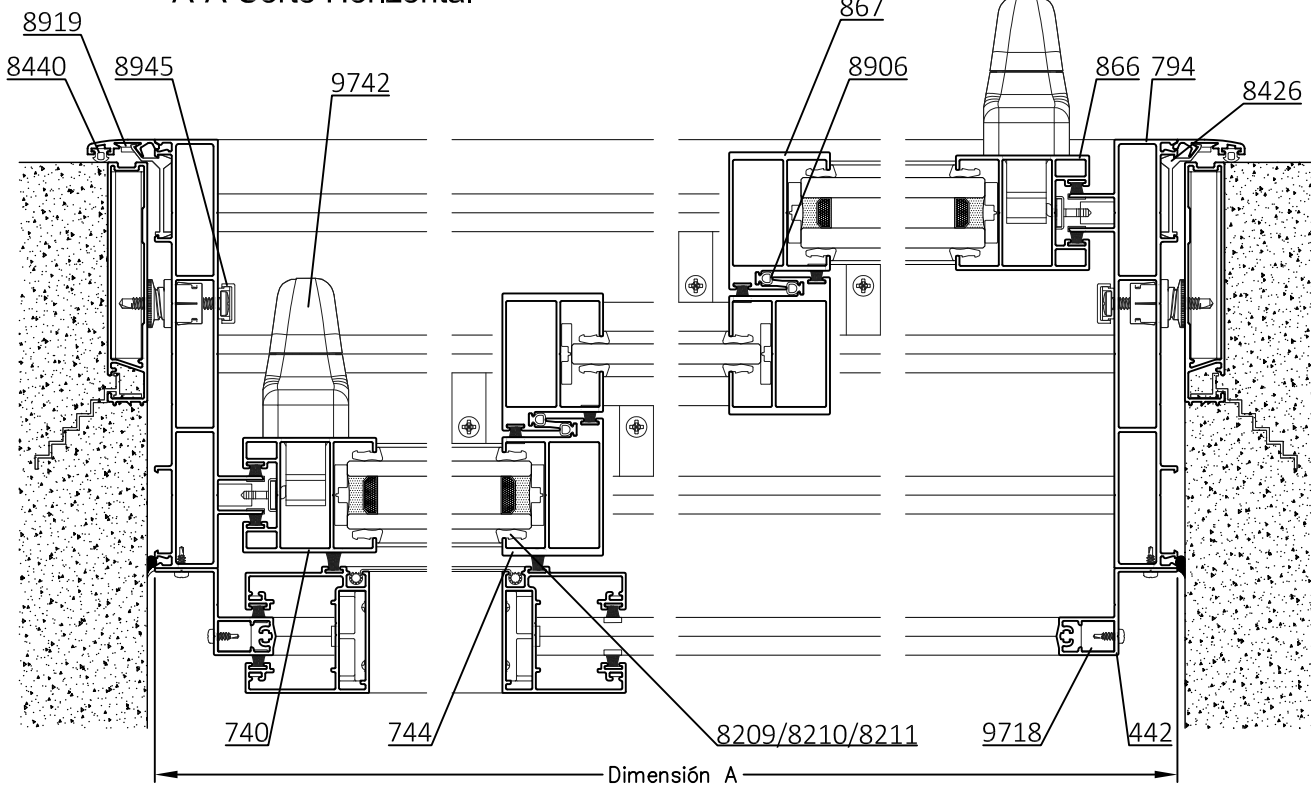

B-B Corte Vertical

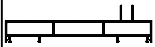

A-A Corte Horizontal



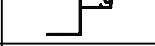















Dimensiones de Corte				Ventana Corrediza			Puerta Corrediza		
Código	Peso Kg/m	Forma	Función	Cant.	Largo	Corte	Cant.	Largo	Corte
1110794	2,14		Jamba	2	H	90° 90°	2	H	90° 90°
1110793	2,54		Umbral Dintel	2	A-50	90° 90°	2	A-50	90° 90°
1060561	0,09		Guía Inf. Marco	3	A-50	90° 90°	3	A-50	90° 90°
1110740 / 1110716 1110866	1,10 / 1,04 1,02		Parante Lateral	2	H-78	90° 90°	2	H-78	90° 90°
1110744 / 1110717 1110867	1,21 / 1,16 1,13		Parante Central	4	H-78	90° 90°	4	H-78	90° 90°
1110745/1110724 1110868	0,98 / 0,91 0,89		Cabezal Zócalo	6	A/3-9	90° 90°	3	A/3-9	90° 90°
1110748/1110728 1110869	1,54 / 1,49 1,47		Zócalo Alto	-	-	-	3	A/3-9	90° 90°
1110442	0,51		Guía mosq.	2	A	45° 45°	2	A	45° 45°
				2	H	45° 45°	2	H	45° 45°
1110441	1,02		Hoja mosq.	2	A/3+16	45° 45°	2	A/3+16	45° 45°
				2	H-78	45° 45°	2	H-78	45° 45°

Dimensiones de Corte Contramarco: pág. 3

\* Medidas en milímetros

Dimensiones de Corte Premarco: pág. 4

Detalle de Accesorios				V. Corrediza	P. Corrediza
Ítem	Código	Descripción	Forma	Cantidad	Cantidad
Escuadra armado	8423	Escuadra armado mosquitero E-69		4 Unidades	4 Unidades
	9718	Escuadra guía mosquitero		4 Unidades	4 Unidades
Tornillo	8368	Tornillo Parker Parte I		24 Unidades	28 Unidades
Cuña Vidrio	8209	Cuña Chica		4A + 12H	4A + 12H
	8210	Cuña Mediana			
	8211	Cuña Grande			
Burlete Hermetic. Felpa	8906	Burlete AEL europeo parante central		4H	4H
	8316	Felpa de Polipropileno 7 x 6 mm.		6A + 14H	6A + 14H
Cierre Multipunto	9742	Cierre lateral multipunto hoja 90° H-132		2 Unidades	2 Unidades
Rodamientos	9974	Rueda simple JN 80 Kg hoja R-46		6 Unidades	-
	8125	Rueda simple Carrera 100 Kg hoja R-46			
	8140	Rueda simple Pabose 150 Kg hoja R-46			
	9975	Rueda doble JN 180 Kg hoja R-47		-	6 Unidades
	8126	Rueda doble Carrera 200 Kg hoja R-47			
	8141	Rueda doble Pabose 300 Kg hoja R-47			
	8932	Rueda simple Torino 40 kg hoja p/ mosqu.	-	2 Unidades	2 Unidades
Tope Central y Lat	9736	Tope Parante Central T-156		8 Unidades	8 Unidades
	9737	Tope Parante Lateral T-157		4 Unidades	4 Unidades
Cruce de Hoja	9728	Cruce de Hoja hoja 90° 2 guías T-158		2 Unidades	2 Unidades
	9729	Cruce de Hoja hoja 90° 3 guías T-159		2 Unidades	2 Unidades
Boca Desagüe	8946	Boca Desagüe T-94 T-130		s/m	s/m
Tapa Desagüe	8366	Tapa Desagüe T-69 T-131		2 Unidades	2 Unidades
Junta estanqueidad	9733	Junta de estanqu. marco corr. 3 guías T-163		2 Pares	2 Pares

s/m: según medida.

Accesorios Contramarco: pág. 3 Premarco: pág. 4

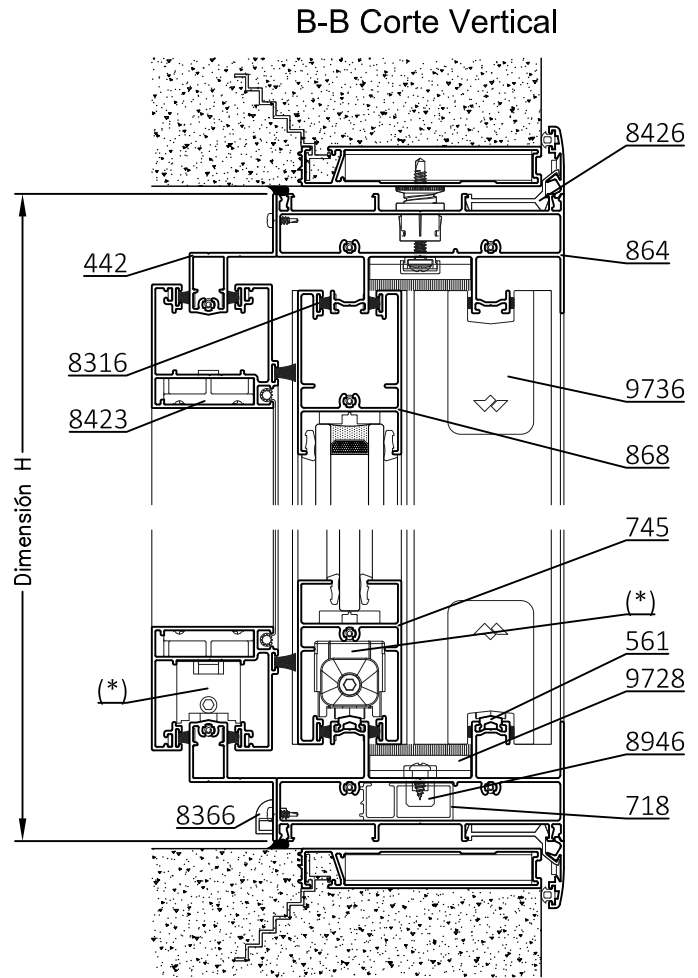
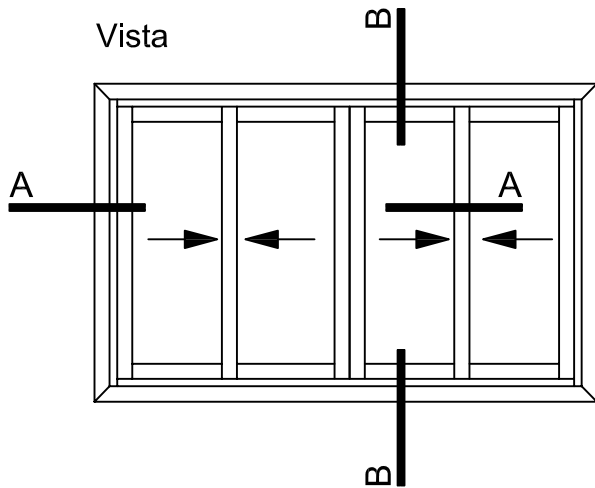





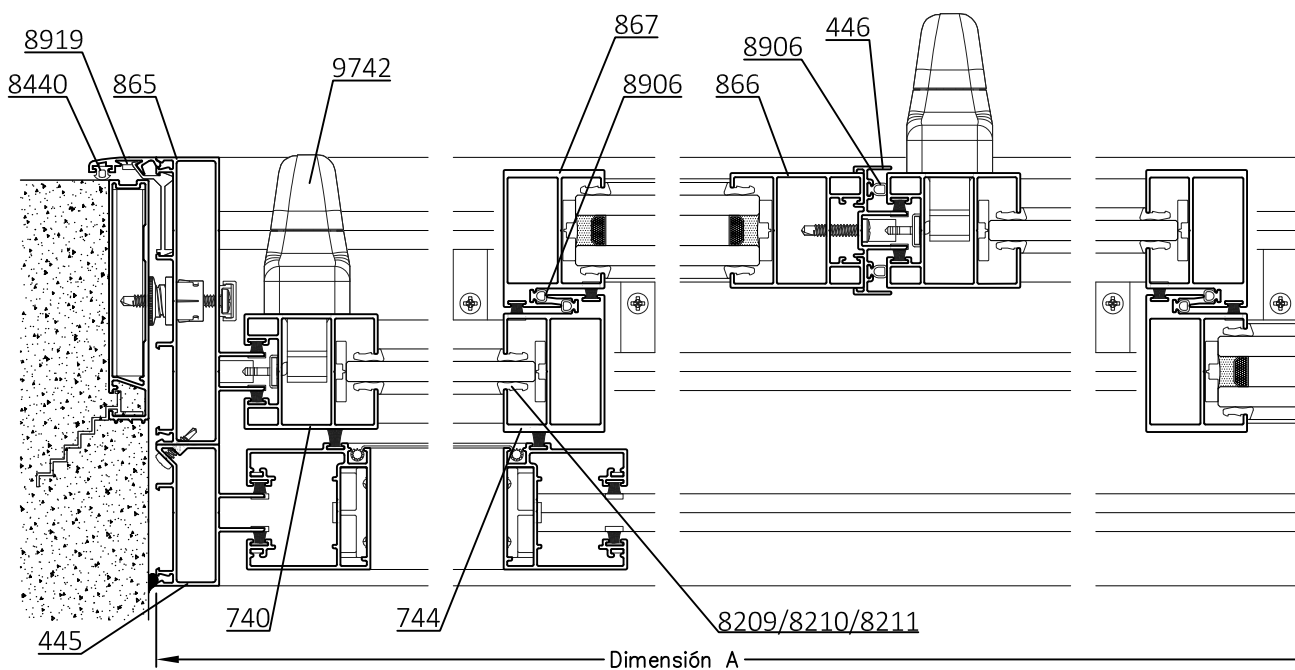

(\* ) ver tabla de ruedas

A-A Corte Horizontal

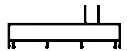
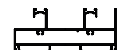

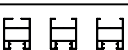
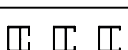
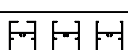
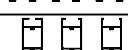
Escala 1:2.5



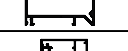









Tolerancia en Peso +/- 10%

Dimensiones de Corte				Ventana Corrediza			Puerta Corrediza		
Código	Peso Kg/m	Forma	Función	Cant.	Largo	Corte	Cant.	Largo	Corte
1110865	1,29		Jamba	2	H	90° 90°	2	H	90° 90°
1110864	1,79		Umbral Dintel	2	A-50	90° 90°	2	A-50	90° 90°
1060561	0,09		Guía Inf. Marco	2	A-50	90° 90°	2	A-50	90° 90°
1110740 / 1110716 1110866	1,10 / 1,04 1,02		Parante Lateral	4	H-78	90° 90°	4	H-78	90° 90°
1110744 / 1110717 1110867	1,21 / 1,16 1,13		Parante Central	4	H-78	90° 90°	4	H-78	90° 90°
1110745 / 1110724 1110868	0,98 / 0,91 0,89		Cabezal Zócalo	8	A/4-16	90° 90°	4	A/4-16	90° 90°
1110748 / 1110728 1110869	1,54 / 1,49 1,47		Zócalo Alto	-	-	-	4	A/4-16	90° 90°
1110446	0,49		Enc. central	1	H-78	90° 90°	1	H-78	90° 90°
1110442	0,51		Guía mosq.	2	A-50	90° 90°	2	A-50	90° 90°
1110445	0,82		Guía mosq.	2	H	90° 90°	2	H	90° 90°
1110441	1,02		Hoja mosq.	2	A/4+9	45° 45°	2	A/4+4	45° 45°
				2	H-78	45° 45°	2	H-78	45° 45°

Dimensiones de Corte Contramarco: pág. 3

\* Medidas en milímetros

Dimensiones de Corte Premarco: pág. 4

Detalle de Accesorios				V. Corrediza	P. Corrediza
Ítem	Código	Descripción	Forma	Cantidad	Cantidad
Escuadra armado	8423	Escuadra armado mosquitero E-69		4 Unidades	4 Unidades
Tornillo	8368	Tornillo Parker Parte I		24 Unidades	28 Unidades
Cuña Vidrio	8209	Cuña Chica		4A + 16H	4A + 16H
	8210	Cuña Mediana			
	8211	Cuña Grande			
Burlete Hermetic. Felpa	8906	Burlete AEL europeo parante central		6H	6H
	8316	Felpa de Polipropileno 7 x 6 mm.		6A + 16H	6A + 16H
Cierre Multipunto	9742	Cierre lateral multipunto hoja 90° H-132		3 Unidades	3 Unidades
Rodamientos	9974	Rueda simple JN 80 Kg hoja R-46		8 Unidades	-
	8125	Rueda simple Carrera 100 Kg hoja R-46			
	8140	Rueda simple Pabose 150 Kg hoja R-46			
	9975	Rueda doble JN 180 Kg hoja R-47		-	8 Unidades
	8126	Rueda doble Carrera 200 Kg hoja R-47			
	8141	Rueda doble Pabose 300 Kg hoja R-47			
	8932	Rueda simple Torino 40 kg hoja p/ mosqu.	-	2 Unidades	2 Unidades
Tope Central y Lat	9736	Tope Parante Central T-156		8 Unidades	8 Unidades
	9737	Tope Parante Lateral T-157		6 Unidades	6 Unidades
Cruce de Hoja	9728	Cruce de Hoja hoja 90° T-158		4 Unidades	4 Unidades
Boca Desagüe	8946	Boca Desagüe T-94 T-130		s/m	s/m
Tapa Desagüe	8366	Tapa Desagüe T-69 T-131		2 Unidades	2 Unidades
Junta estanqueidad	9732	Junta de estanqu. marco corr. 2 guías T-162		2 Pares	2 Pares

s/m: según medida.

Accesorios Contramarco: pág. 3 Premarco: pág. 4

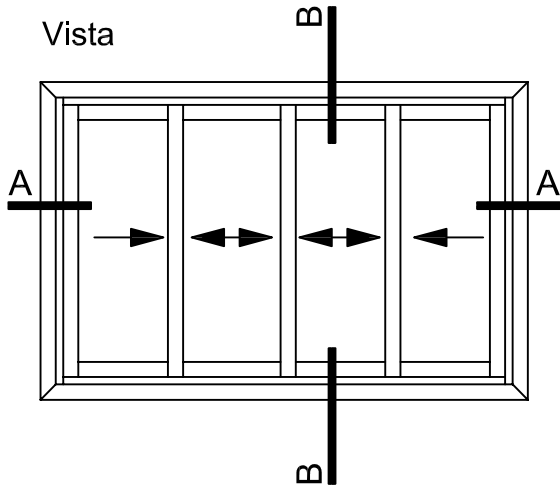

(\*) ver tabla de ruedas

B-B Corte Vertical

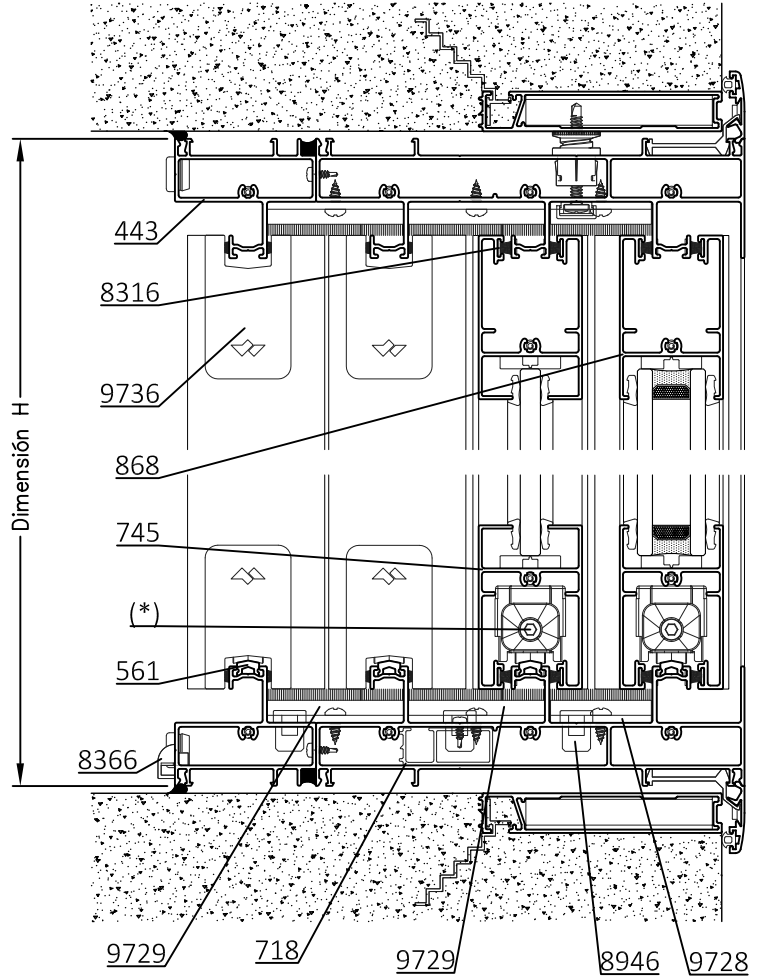



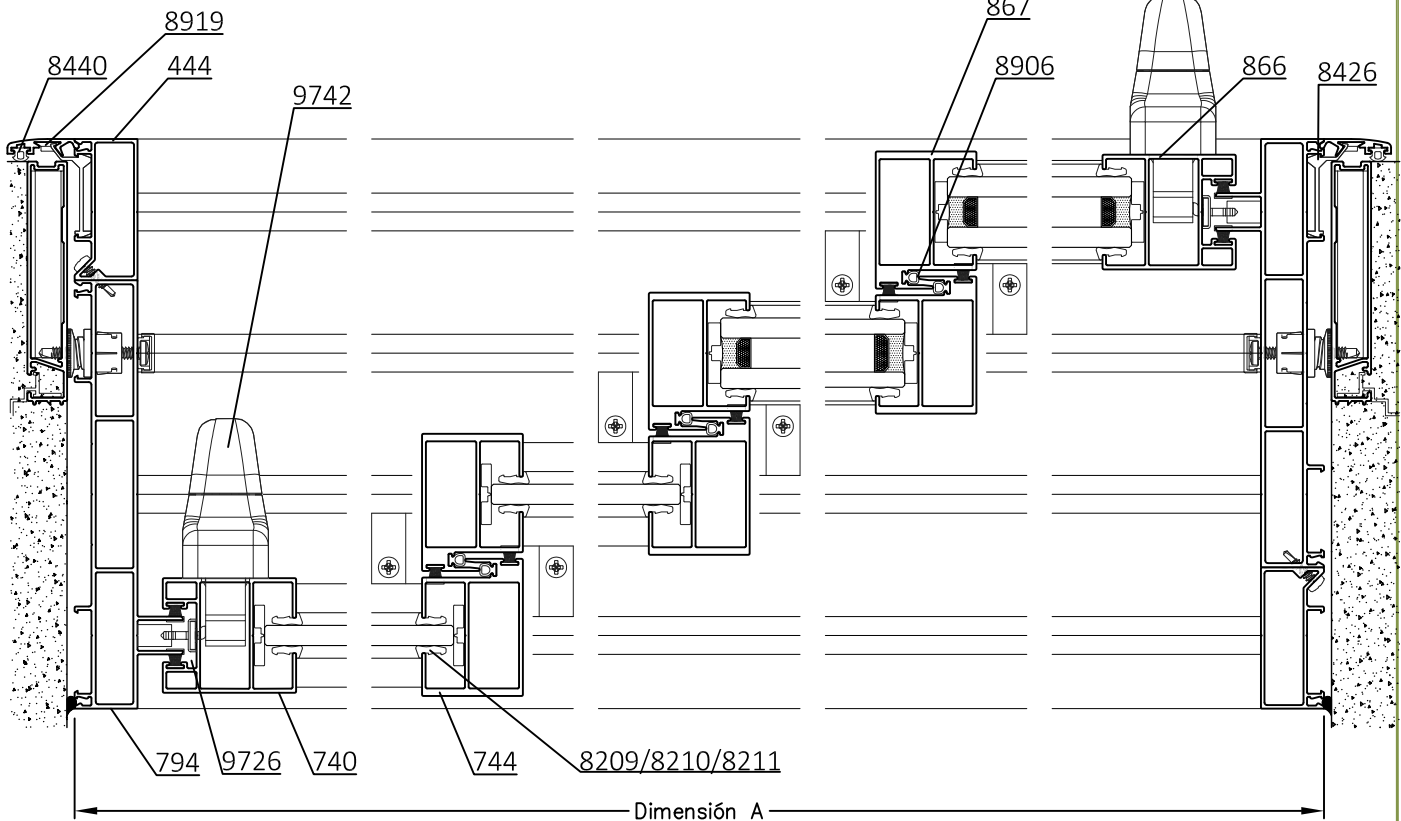



A-A Corte Horizontal

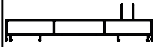



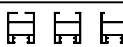
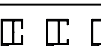

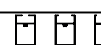





Escala 1:3

Tolerancia en Peso +/- 10%

Dimensiones de Corte				Ventana Corrediza			Puerta Corrediza		
Código	Peso Kg/m	Forma	Función	Cant.	Largo	Corte	Cant.	Largo	Corte
1110794	2,14		Jamba	2	H	90° 90°	2	H	90° 90°
1110793	2,54		Umbral Dintel	2	A-50	90° 90°	2	A-50	90° 90°
1110444	0,69		Jamba	2	H	90° 90°	2	H	90° 90°
1110443	1,69		Umbral Dintel	2	A-50	90° 90°	2	A-50	90° 90°
1060561	0,09		Guía Inf. Marco	4	A-50	90° 90°	4	A-50	90° 90°
1110740 / 1110716 1110866	1,10 / 1,04 1,02		Parante Lateral	2	H-78	90° 90°	2	H-78	90° 90°
1110744 / 1110717 1110867	1,21 / 1,16 1,13		Parante Central	6	H-78	90° 90°	6	H-78	90° 90°
1110745 / 1110724 1110868	0,98 / 0,91 0,89		Cabezal Zócalo	8	A/4+3	90° 90°	4	A/4+3	90° 90°
1110748 / 1110728 1110869	1,54 / 1,49 1,47		Zócalo Alto	-	-	-	4	A/4+3	90° 90°

Dimensiones de Corte Contramarco: pág. 3 \* Medidas en milímetros  
Dimensiones de Corte Premarco: pág. 4





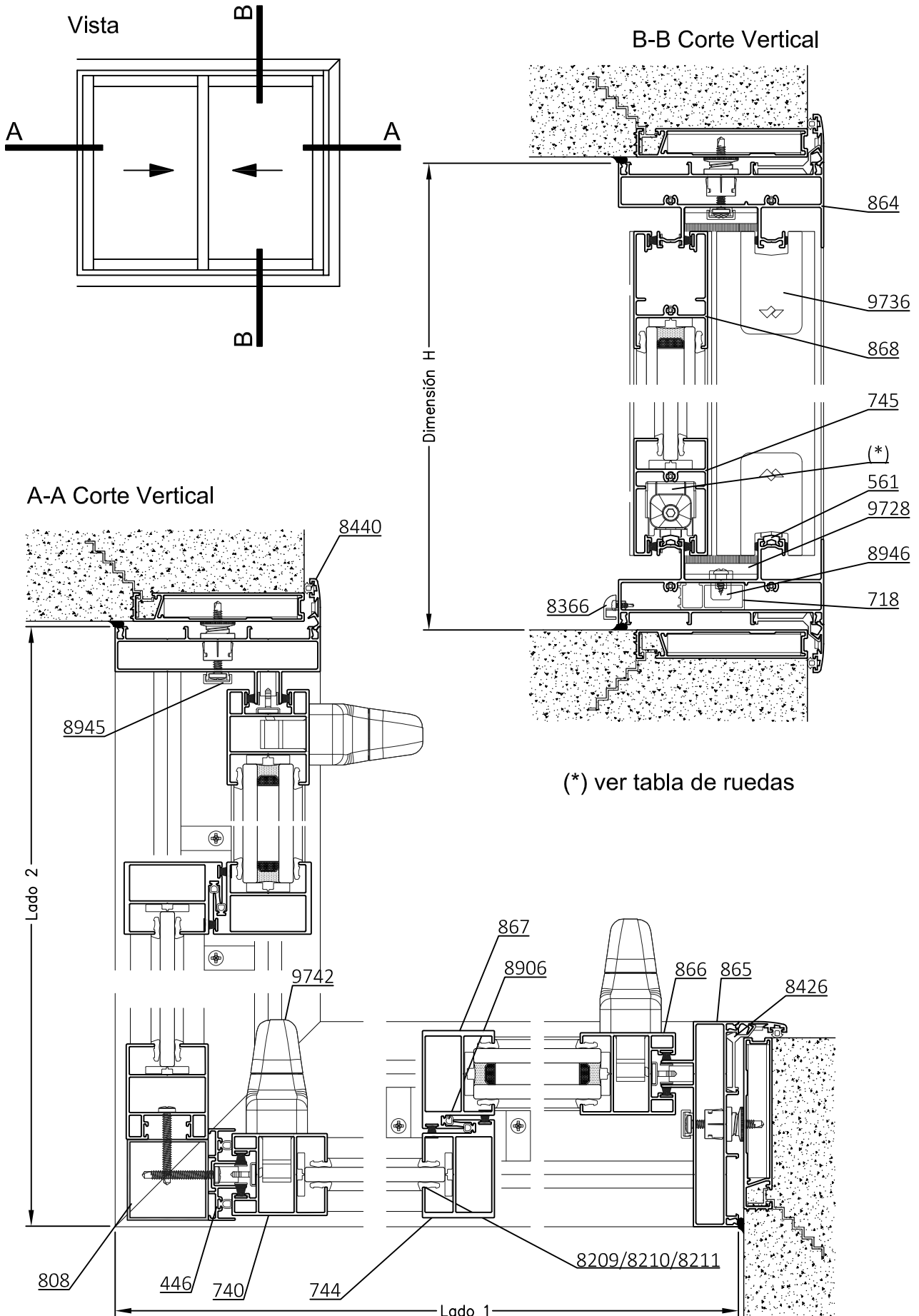

Detalle de Accesorios				V. Corrediza	P. Corrediza
Ítem	Código	Descripción	Forma	Cantidad	Cantidad
Tornillo	8368	Tornillo Parker Parte I		32 Unidades	36 Unidades
Cuña Vidrio	8209	Cuña Chica		4A + 16H	4A + 16H
	8210	Cuña Mediana			
	8211	Cuña Grande			
Burlete Hermetic.	8906	Burlete AEL europeo parante central		6H	6H
Felpa	8316	Felpa de Polipropileno 7 x 6 mm.		4A + 10H	4A + 10H
Cierre Multipunto	9742	Cierre lateral multipunto hoja 90° H-132		2 Unidades	2 Unidades
Rodamientos	9974	Rueda simple JN 80 Kg hoja R-46		8 Unidades	-
	8125	Rueda simple Carrera 100 Kg hoja R-46			
	8140	Rueda simple Pabose 150 Kg hoja R-46			
	9975	Rueda doble JN 180 Kg hoja R-47		-	8 Unidades
	8126	Rueda doble Carrera 200 Kg hoja R-47			
8141	Rueda doble Pabose 300 Kg hoja R-47				
Tope Central y Lat	9736	Tope Parante Central T-156		12 Unidades	12 Unidades
	9737	Tope Parante Lateral T-157		4 Unidades	4 Unidades
Cruce de Hoja	9728	Cruce de Hoja hoja 90° 2 guías T-158		2 Unidades	2 Unidades
	9729	Cruce de Hoja hoja 90° 3 guías T-159		4 Unidades	4 Unidades
Boca Desagüe	8946	Boca Desagüe T-94 T-130		s/m	s/m
Tapa Desagüe	8366	Tapa Desagüe T-69 T-131		2 Unidades	2 Unidades
Junta estanqueidad	9733	Junta de estanqu. marco corr. 3 guías T-163		2 Pares	2 Pares
	9725	Junta de estanqu. marco corr. 1 guía		2 Pares	2 Pares



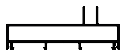



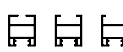
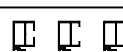
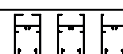

s/m: según medida.

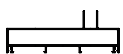
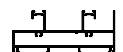



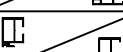

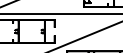



Accesorios Contramarco: pág. 3 Premarco: pág. 4



(\* ver tabla de ruedas

				LADO 1					
Dimensiones de Corte				Ventana Corrediza			Puerta Corrediza		
Código	Peso Kg/m	Forma	Función	Cant.	Largo	Corte	Cant.	Largo	Corte
1110865	1,29		Jamba	1	H	90° 90°	1	H	90° 90°
1110864	1,79		Umbral Dintel	2	A-25	90° 45°	2	A-25	90° 45°
1060561	0,09		Guía Inf. Marco	1	A-25	90° 45°	1	A-25	90° 45°
1060561	0,09		Guía Inf. Marco	1	A-81	90° 45°	1	A-81	90° 45°
1110740 /1110716 1110866	1,10 / 1,04 1,02		Parante Lateral	2	H-78	90° 90°	2	H-78	90° 90°
1110744 /1110717 1110867	1,21 / 1,16 1,13		Parante Central	2	H-78	90° 90°	2	H-78	90° 90°
1110745/1110724 1110868	0,98 / 0,91 0,89		Cabezal Zócalo	4	A/2-46	90° 90°	2	A/2-46	90° 90°
1110748/1110728 1110869	1,54 / 1,49 1,47		Zócalo Alto	-	A/2-46	90° 90°	2	A/2-46	90° 90°

				LADO 2					
Dimensiones de Corte				Ventana Corrediza			Puerta Corrediza		
Código	Peso Kg/m	Forma	Función	Cant.	Largo	Corte	Cant.	Largo	Corte
1110865	1,29		Jamba	1	H	90° 90°	1	H	90° 90°
1110864	1,79		Umbral Dintel	2	A-25	90° 45°	2	A-25	90° 45°
1060561	0,09		Guía Inf. Marco	1	A-25	90° 45°	1	A-25	90° 45°
1060561	0,09		Guía Inf. Marco	1	A-81	90° 45°	1	A-81	90° 45°
1110740 (V.S) 1110866 (D.V.H)	1,10 1,02		Parante Lateral	2	H-78	90° 90°	2	H-78	90° 90°
1110744 (V.S) 1110867 (D.V.H)	1,21 1,13		Parante Central	2	H-78	90° 90°	2	H-78	90° 90°
1110745 (V.S) 1110868 (D.V.H)	0,98 0,89		Cabezal Zócalo	4	A/2-38	90° 90°	2	A/2-38	90° 90°
1110748 (V.S) 1110869 (D.V.H)	1,54 1,47		Zócalo Alto	-	A/2-38	90° 90°	2	A/2-38	90° 90°
1090808	0,71		Tubo 45*45	1	H-138	90° 90°	1	H-138	90° 90°
1110446	0,49		Enc. central	1	H-138	90° 90°	1	H-138	90° 90°

Detalle de Accesorios				V. Corrediza	P. Corrediza
Ítem	Código	Descripción	Forma	Cantidad	Cantidad
Tornillo	8368	Tornillo Parker Parte I		24 Unidades	32 Unidades
Cuña Vidrio	8209	Cuña Chica		16A + 16H	16A + 16H
	8210	Cuña Mediana			
	8211	Cuña Grande			
Burlete Hermetic.	8906	Burlete AEL europeo parante central		6H	6H
Felpa	8316	Felpa de Polipropileno 7 x 6 mm.		16A + 12H	16A + 12H
Cierre Multipunto	9742	Cierre lateral multipunto hoja 90° H-132		3 Unidades	3 Unidades
Rodamientos	9974	Rueda simple JN 80 Kg hoja R-46		8 Unidades	
	8125	Rueda simple Carrera 100 Kg hoja R-46			
	8140	Rueda simple Pabose 150 Kg hoja R-46			
	9975	Rueda doble JN 180 Kg hoja R-47			8 Unidades
	8126	Rueda doble Carrera 200 Kg hoja R-47			
	8141	Rueda doble Pabose 300 Kg hoja R-47			
Tope Central y Lat	9736	Tope Parante Central T-156		8 Unidades	8 Unidades
	9737	Tope Parante Lateral T-157		8 Unidades	8 Unidades
Cruce de Hoja	9728	Cruce de Hoja hoja 90° T-158		4 Unidades	4 Unidades
Boca Desagüe	8946	Boca Desagüe T-94 T-130		s/m	s/m
Tapa Desagüe	8366	Tapa Desagüe T-69 T-131		4 Unidades	4 Unidades
Junta estanqueidad	9732	Junta de estanqu. marco corr. 2 guías T-162		2 Pares	2 Pares
acc. encuentro a 90		Tapón Tubo 808 / encuentro a 90°		1 Par	1 Par





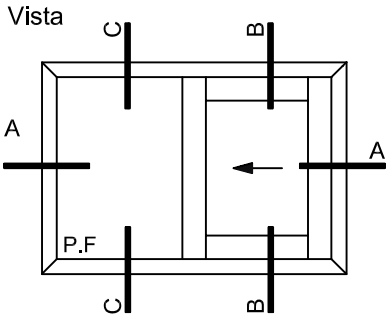

C-C Corte Vertical

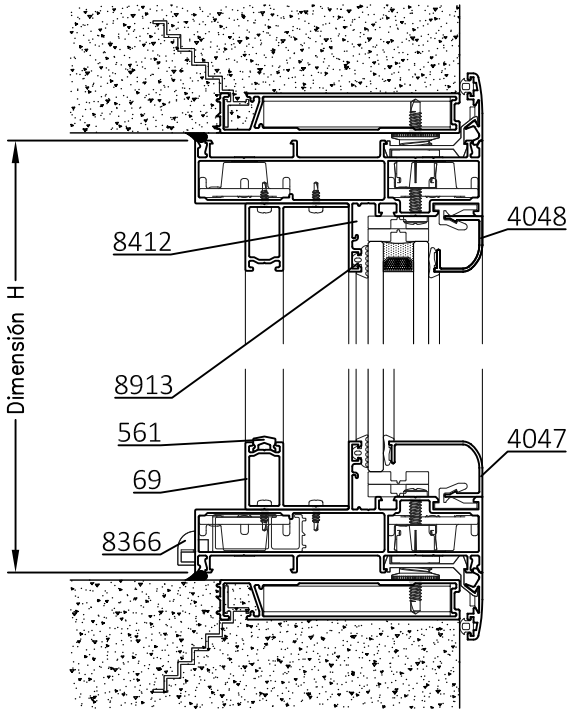



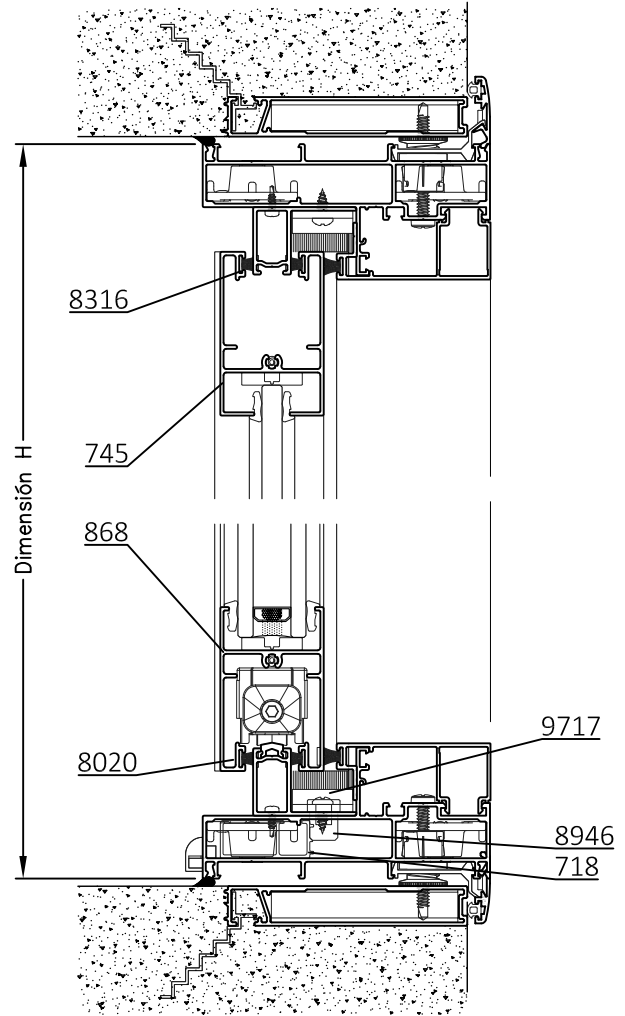



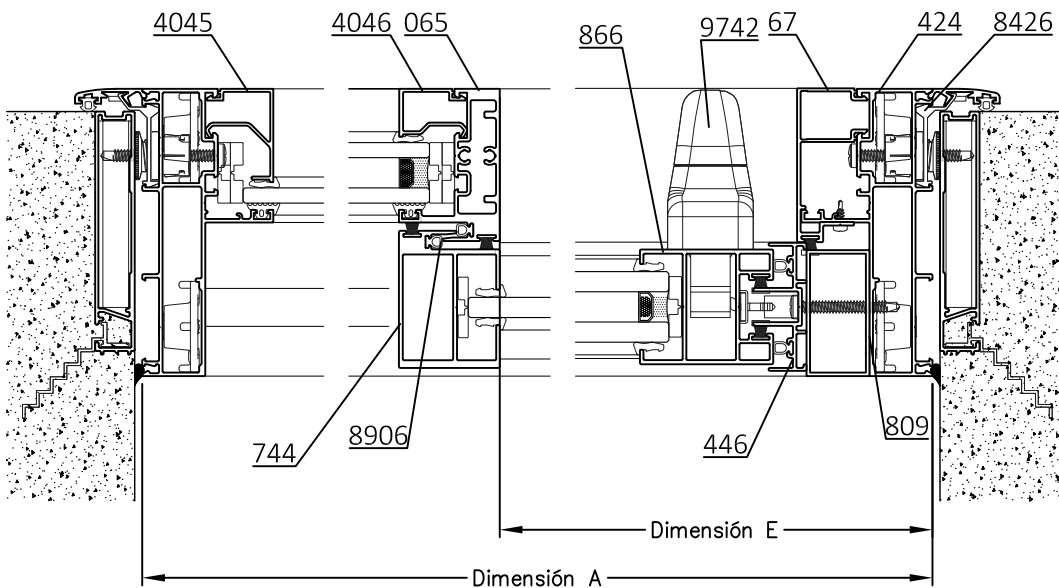

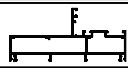
B-B Corte Vertical

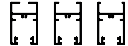
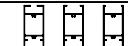

A-A Corte Horizontal

















Dimensiones de Corte				Ventana Corrediza			Puerta Corrediza		
Código	Peso Kg/m	Forma	Función	Cant.	Largo	Corte	Cant.	Largo	Corte
1110424	1,49		Marco	2	A	45° 45°	2	A	45° 45°
				2	H	45° 45°	2	H	45° 45°
4047/4048/ 4050/051/052/053	-	-	Contrav. cpn clip	2	(A-E)-48	45° 45°	2	(A-E)-48	45° 45°
				2	H-60	45° 45°	2	H-60	45° 45°
4045/4046/ 4049	-	-	Contrav. Recto	2	(A-E)-48	90° 90°	2	(A-E)-48	90° 90°
				2	H-104	90° 90°	2	H-104	90° 90°
1110065	1,31		Parante	1	H-60	90° 90°	1	H-60	90° 90°
1060561	0,09		Guía Inf. Marco	1	A-96	90° 90°	1	A-96	90° 90°
1110740 /1110716 1110866	1,10 / 1,04 1,02		Parante Lateral	1	H-86	90° 90°	1	H-86	90° 90°
1110744 /1110717 1110867	1,21 / 1,16 1,13		Parante Central	1	H-86	90° 90°	1	H-86	90° 90°
1110745/1110724 1110868	0,98 / 0,91 0,89		Cabezal Zócalo	2	E-40	90° 90°	1	E-40	90° 90°
1110748/1110728 1110869	1,54 / 1,49 1,47		Zócalo Alto	-	-	-	1	E-40	90° 90°
1110067	0,55		Cierre marco	2	E-54	90° 90°	2	E-54	90° 90°
				1	H-60	90° 90°	1	H-60	90° 90°
1110446	0,49		Enc. central	1	H-50	90° 90°	1	H-50	90° 90°
1090809	0,55		Tubo 50 x 25	1	H-50	90° 90°	1	H-50	90° 90°
1110069	0,42		Guía fija móvil	2	A-96	90° 90°	2	A-96	90° 90°

Dimensiones de Corte Contramarco: pág. 3

\* Medidas en milímetros

Dimensiones de Corte Premarco: pág. 4

Detalle de Accesorios				S/Travesaño
Ítem	Código	Descripción	Forma	Cantidad
Esc. de Armado	9821 8047	Esc. de Armado Marco E-83		8 Unidades
Clip	8916	Clip Contravidrios T-96		s/m
Burlete Vidrio	8913	Burlete de Acristalamiento B-68		2A-E + 2H
Cuña Vidrio	8209	Cuña Chica		2A-E + 2H
	8210	Cuña Mediana		4E + 4H
	8211	Cuña Grande		
Tornillo	8368	Tornillo Parker Parte I		4 Unidades
Tapón Hermetic.	9722	Tapón de Hermeticidad Caja de Agua		2 Unidades
Burlete Hermetic.	8906	Burlete AEL europeo		4H
Felpa	8316	Felpa de Polipropileno 7 x 6 mm.		6E + 7H
Cierre Multipunto	9742	Cierre lateral multipunto hoja 90° H-132		1 Unidad
Rodamientos	9974	Rueda simple JN 80 Kg hoja R-46		2 Unidades
	8125	Rueda simple Carrera 100 Kg hoja R-46		
	8140	Rueda simple Pabose 150 Kg hoja R-46		
	9975	Rueda doble JN 180 Kg hoja R-47		
	8126	Rueda doble Carrera 200 Kg hoja R-47		
	8141	Rueda doble Pabose 300 Kg hoja R-47		
Tope Central y Lat	9736	Tope Parante Central T-156		2 Unidades
	9737	Tope Parante Lateral T-157		2 Unidades
Cruce de Hoja	9717	Cruce de Hoja Fija Móvil		2 Unidades
Boca Desagüe	8946	Boca Desagüe T-94 T-130		s/m
Tapa Desagüe	8366	Tapa Desagüe T-69 T-131		2 Unidades

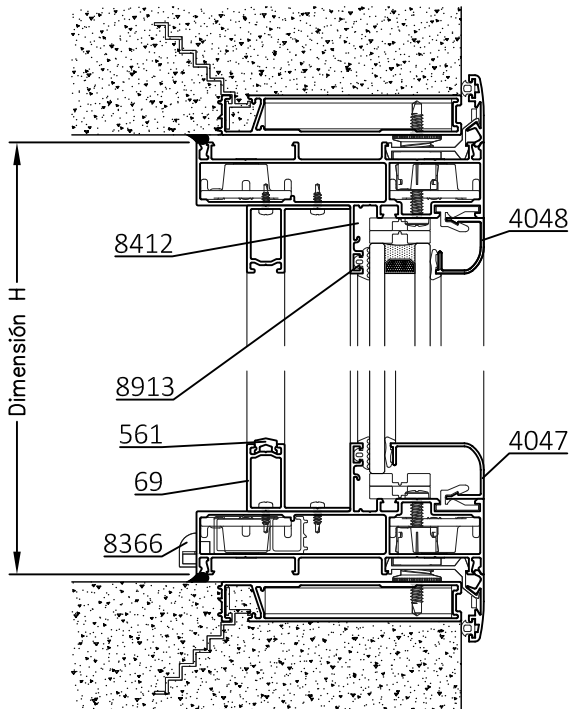
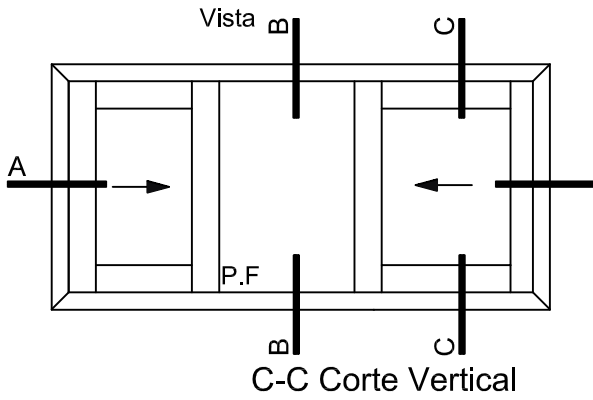

C-C Corte Vertical

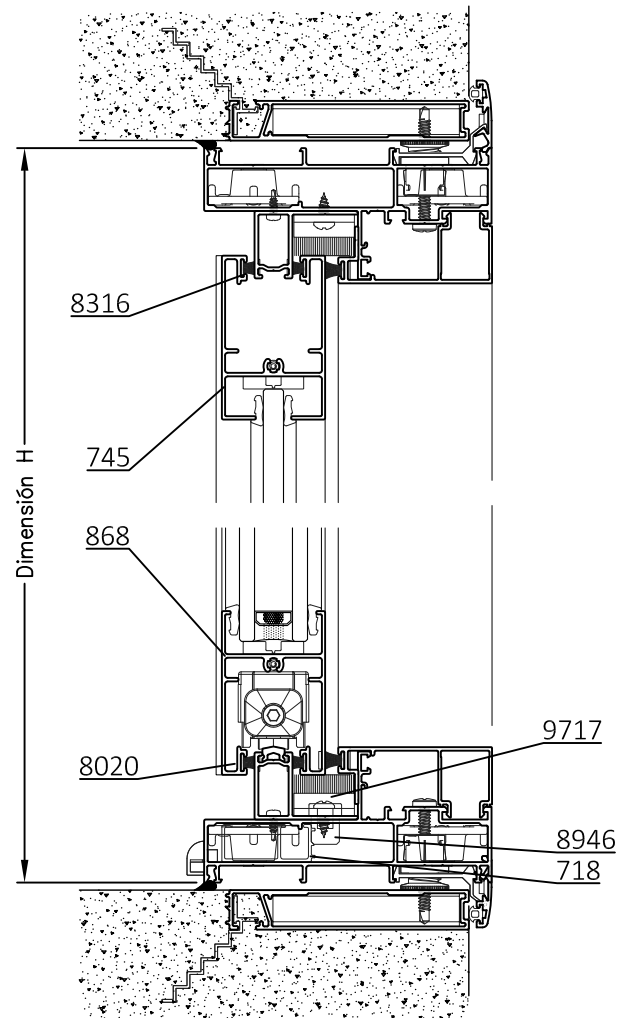

A-A Corte Horizontal

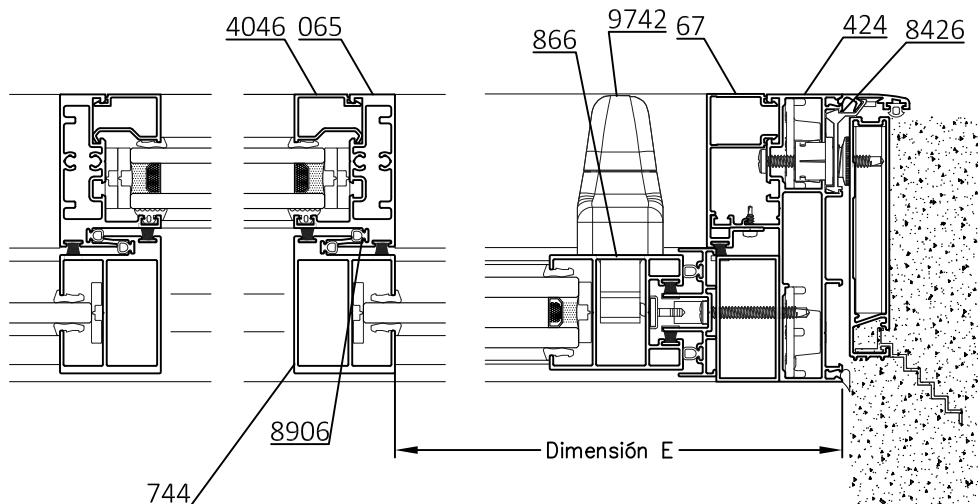









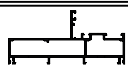

Escala 1:3

Tolerancia en Peso +/- 10%

44

09 - 2024















NIZA

Dimensiones de Corte				Ventana Corrediza			Puerta Corrediza		
Código	Peso Kg/m	Forma	Función	Cant.	Largo	Corte	Cant.	Largo	Corte
1110424	1,49		Marco	2	A	45° 45°	2	A	45° 45°
				2	H	45° 45°	2	H	45° 45°
4047/4048/ 4050/051/052/053	-	-	Contrav. con clip	2	(A-2E)-36	45° 45°	2	(A-2E)-36	45° 45°
				2	H-60	45° 45°	2	H-60	45° 45°
4045/4046/ 4049	-	-	Contrav. Recto	2	(A-2E)-80	90° 90°	2	(A-2E)-80	90° 90°
				2	H-60	90° 90°	2	H-60	90° 90°
1110065	1,31		Parante	2	H-60	90° 90°	2	H-60	90° 90°
1060561	0,09		Guía Inf. Marco	1	A-152	90° 90°	1	A-152	90° 90°
1110740 /1110716 1110866	1,10 / 1,04 1,02		Parante Lateral	2	H-86	90° 90°	2	H-86	90° 90°
1110744 /1110717 1110867	1,21 / 1,16 1,13		Parante Central	2	H-86	90° 90°	2	H-86	90° 90°
1110745/1110724 1110868	0,98 / 0,91 0,89		Cabezal Zócalo	4	E-40	90° 90°	2	E-40	90° 90°
1110748/1110728 1110869	1,54 / 1,49 1,47		Zócalo Alto	-	-	-	2	E-40	90° 90°
1110067	0,55		Cierre marco	4	E-53	90° 90°	4	E-53	90° 90°
				2	H-60	90° 90°	2	H-60	90° 90°
1110446	0,49		Enc. central	2	H-50	90° 90°	2	H-50	90° 90°
1090809	0,55		Tubo 50 x 25	2	H-50	90° 90°	2	H-50	90° 90°
1110069	0,42		Guía fija móvil	2	A-152	90° 90°	2	A-152	90° 90°

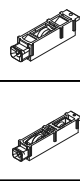
Dimensiones de Corte Contramarco: pág. 3

\* Medidas en milímetros

Dimensiones de Corte Premarco: pág. 4

Detalle de Accesorios				S/Travesaño
Ítem	Código	Descripción	Forma	Cantidad
Esc. de Armado	9821 8047	Esc. de Armado Marco E-83		8 Unidades
Clip	8916	Clip Contravidrios T-96		s/m
Burlete Vidrio	8913	Burlete de Acristalamiento B-68		2A-E + 2H
Cuña Vidrio	8209	Cuña Chica		4A-E + 8H
	8210	Cuña Mediana		4E + 4H
	8211	Cuña Grande		
Tornillo	8368	Tornillo Parker Parte I		4 Unidades
Tapón Hermetic.	9722	Tapón de Hermeticidad Caja de Agua		2 Unidades
Burlete Hermetic.	8906	Burlete AEL europeo		8H
Felpa	8316	Felpa de Polipropileno 7 x 6 mm.		8E + 9H
Cierre Multipunto	9742	Cierre lateral multipunto hoja 90° H-132		2 Unidades
Rodamientos	9974	Rueda simple JN 80 Kg hoja R-46		4 Unidades
	8125	Rueda simple Carrera 100 Kg hoja R-46		
	8140	Rueda simple Pabose 150 Kg hoja R-46		
	9975	Rueda doble JN 180 Kg hoja R-47		
	8126	Rueda doble Carrera 200 Kg hoja R-47		
	8141	Rueda doble Pabose 300 Kg hoja R-47		
Tope Central y Lat	9736	Tope Parante Central T-156		4 Unidades
	9737	Tope Parante Lateral T-157		4 Unidades
Cruce de Hoja	9717	Cruce de Hoja Fija Móvil		2 Unidades
Boca Desagüe	8946	Boca Desagüe T-94 T-130		s/m
Tapa Desagüe	8366	Tapa Desagüe T-69 T-131		2 Unidades

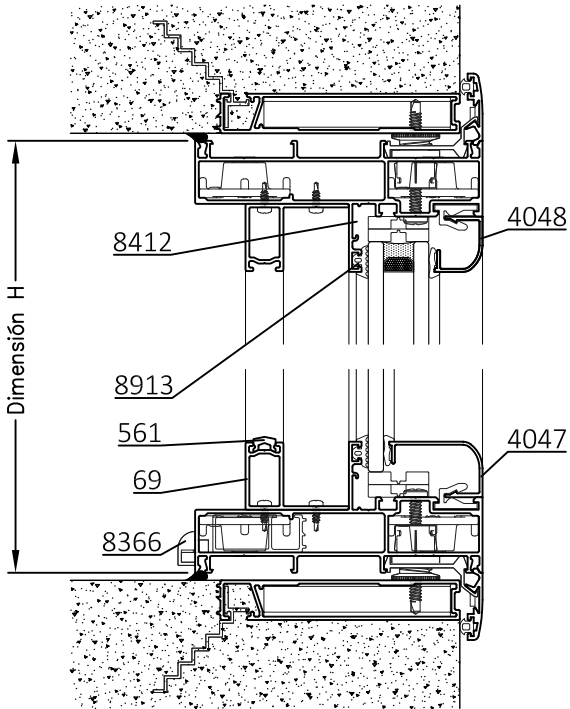
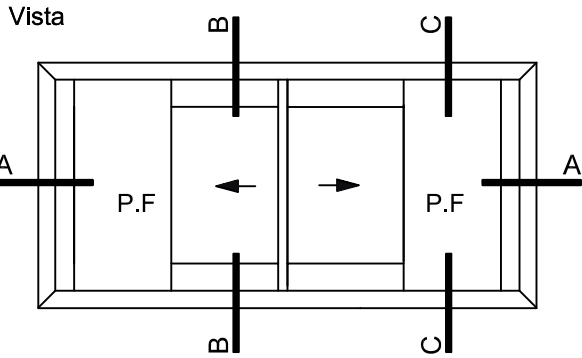

C-C Corte Vertical

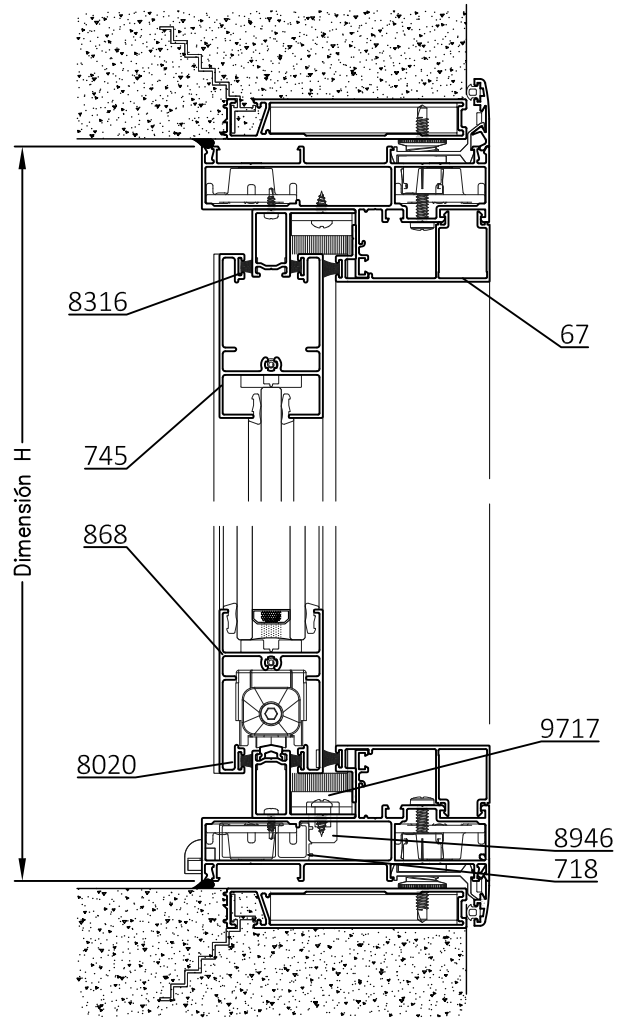

A-A Corte Horizontal

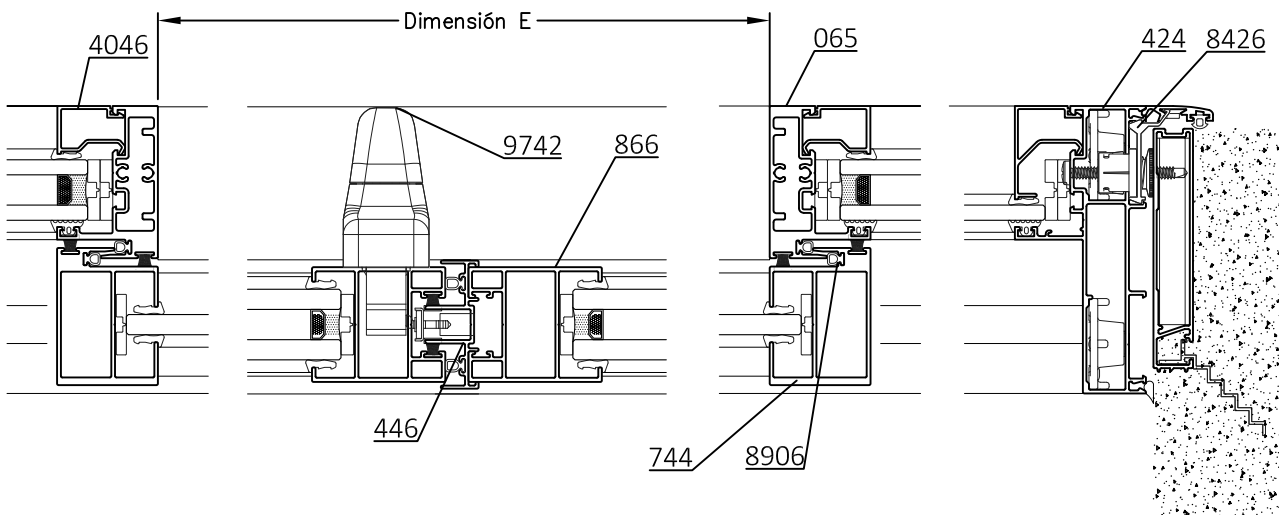







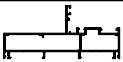

Escala 1:3

Tolerancia en Peso +/- 10%

46

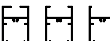
09 - 2024

















NIZA

Dimensiones de Corte				Ventana Corrediza			Puerta Corrediza		
Código	Peso Kg/m	Forma	Función	Cant.	Largo	Corte	Cant.	Largo	Corte
1110424	1,49		Marco	2	A	45° 45°	2	A	45° 45°
				2	H	45° 45°	2	H	45° 45°
4047/4048/ 4050/051/052/053	-	-	Contrav. con clip	4	[(A-E)/2]-48	45° 45°	4	[(A-E)/2]-48	45° 45°
				4	H-60	45° 45°	4	H-60	45° 45°
4045/4046/ 4049	-	-	Contrav. Recto	4	[(A-E)/2]-92	90° 90°	4	[(A-E)/2]-92	90° 90°
				4	H-60	90° 90°	4	H-60	90° 90°
1110065	1,31		Parante	2	H-60	90° 90°	2	H-60	90° 90°
1060561	0,09		Guía Inf. Marco	A-50	A-60	90° 90°	A-50	A-60	90° 90°
1110740 /1110716 1110866	1,10 / 1,04 1,02		Parante Lateral	2	H-86	90° 90°	2	H-86	90° 90°
1110744 /1110717 1110867	1,21 / 1,16 1,13		Parante Central	2	H-86	90° 90°	2	H-86	90° 90°
1110745/1110724 1110868	0,98 / 0,91 0,89		Cabezal Zócalo	4	(E/2)+19	90° 90°	2	(E/2)+19	90° 90°
1110748/1110728 1110869	1,54 / 1,49 1,47		Zócalo Alto	-	-	-	2	(E/2)+19	90° 90°
1110067	0,55		Cierre marco	2	E	90° 90°	2	E	90° 90°
1110446	0,49		Enc. central	1	H-86	90° 90°	1	H-86	90° 90°
1110069	0,42		Guía fija móvil	2	A-60	90° 90°	2	A-60	90° 90°

Dimensiones de Corte Contramarco: pág. 3

\* Medidas en milímetros

Dimensiones de Corte Premarco: pág. 4

Detalle de Accesorios				S/Travesaño
Ítem	Código	Descripción	Forma	Cantidad
Esc. de Armado	9821 8047	Esc. de Armado Marco E-83		8 Unidades
Clip	8916	Clip Contravidrios T-96		s/m
Burlete Vidrio	8913	Burlete de Acristalamiento B-68		2A-E + 2H
Cuña Vidrio	8209	Cuña Chica		4A-E + 8H
	8210	Cuña Mediana		4E + 4H
	8211	Cuña Grande		
Tornillo	8368	Tornillo Parker Parte I		4 Unidades
Tapón Hermetic.	9722	Tapón de Hermeticidad Caja de Agua		2 Unidades
Burlete Hermetic.	8906	Burlete AEL europeo		4H
Felpa	8316	Felpa de Polipropileno 7 x 6 mm.		6E + 7H
Cierre Multipunto	9742	Cierre lateral multipunto hoja 90° H-132		1 Unidad
Rodamientos	9974	Rueda simple JN 80 Kg hoja R-46		2 Unidades
	8125	Rueda simple Carrera 100 Kg hoja R-46		
	8140	Rueda simple Pabose 150 Kg hoja R-46		
	9975	Rueda doble JN 180 Kg hoja R-47		
	8126	Rueda doble Carrera 200 Kg hoja R-47		
	8141	Rueda doble Pabose 300 Kg hoja R-47		
Tope Central y Lat	9736	Tope Parante Central T-156		2 Unidades
	9737	Tope Parante Lateral T-157		2 Unidades
Cruce de Hoja	9717	Cruce de Hoja Fija Móvil		2 Unidades
Boca Desagüe	8946	Boca Desagüe T-94 T-130		s/m
Tapa Desagüe	8366	Tapa Desagüe T-69 T-131		2 Unidades

Vista

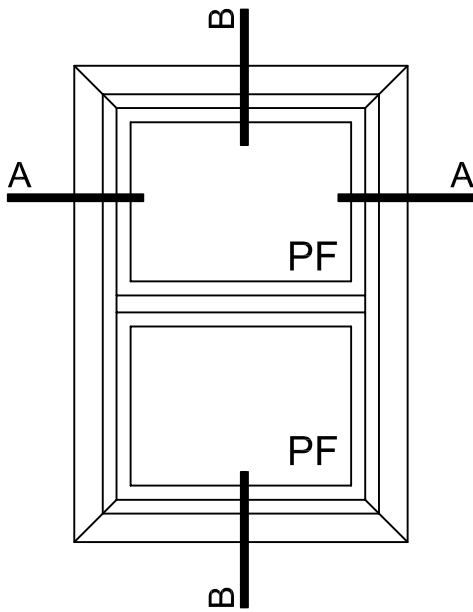

B-B Corte Vertical

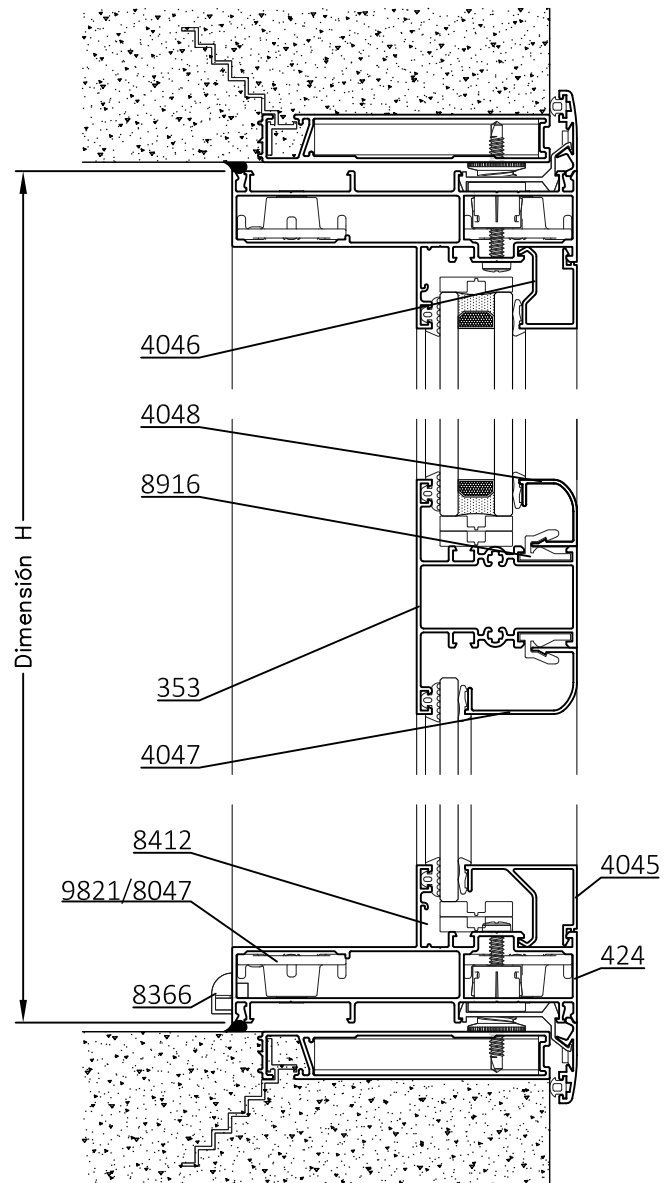

A-A Corte Horizontal

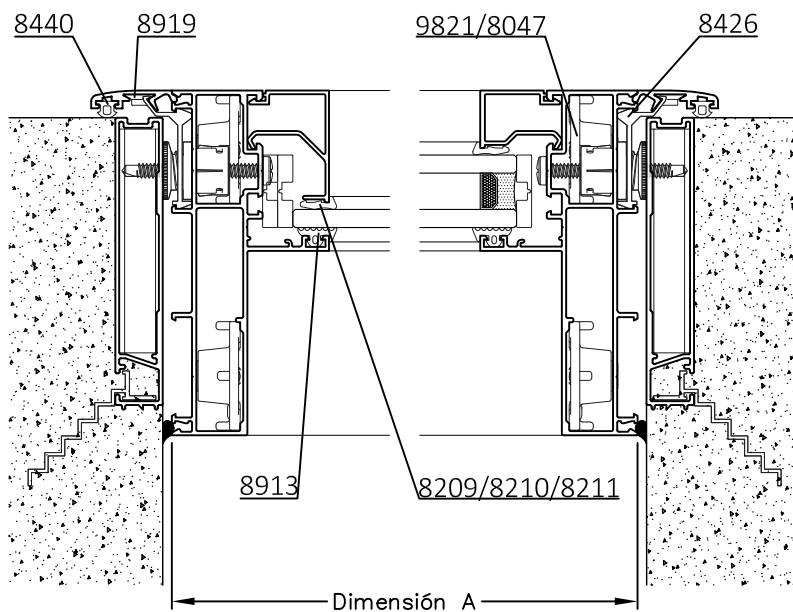

Escala 1:3

Tolerancia en Peso +/- 10%

48

09 - 2024

NIZA



Dimensiones de Corte						
Código	Peso Kg/m	Forma	Función	Cant.	Largo	Corte
1110424	1,49		Marco	2	A	45° 45°
				2	H	45° 45°
4047/4048/ 4050/051/052/053	-	-	Contrav. cpn clip	2	A-60	45° 45°
				2	H-60	45° 45°
4045/4046/ 4049	-	-	Contrav. Recto	2	A-60	90° 90°
				2	H-104	90° 90°
1110353	1,05		Travesaño	-	(AoH)-60	90° 90°

Dimensiones de Corte Contramarco: pág. 3 \* Medidas en milímetros  
Dimensiones de Corte Premarco: pág. 4

Detalle de Accesorios				S/Travesaño	C/ 1 Travesaño
Ítem	Código	Descripción	Forma	Cantidad	Cantidad
Esc. de Armado	9821 8047	Esc. de Armado Marco E-83		8 Unidades	
	8415	Esc. de Alineación Marco E-62	-	4 Unidades	
Clip	8916	Clip Contravidrios T-96		s/m	s/m
Burlete Vidrio	8913	Burlete de Acristamiento B-68		2A + 2H	2A + 2H + 2 Largos x Trav.
Cuña Vidrio	8209	Cuña Chica		2A + 2H	2A + 2H + 2 Largos x Trav.
	8210	Cuña Mediana			
	8211	Cuña Grande			
Tornillo	8368	Tornillo Parker Parte I		-	4 Unidades x Travesaño
Tapón Hermetic.	9722	Tapón de Hermeticidad Caja de Agua		2 Unidades	2 Unidades

s/m: según medida

Accesorios Contramarco: pág. 3 Accesorios Premarco: pág. 4

Es posible combinar el Paño Fijo con Ventanas de Rebatir, Ventanas Oscilo-Batientes y Ventanas Banderola utilizando un mismo Marco Perimetral.

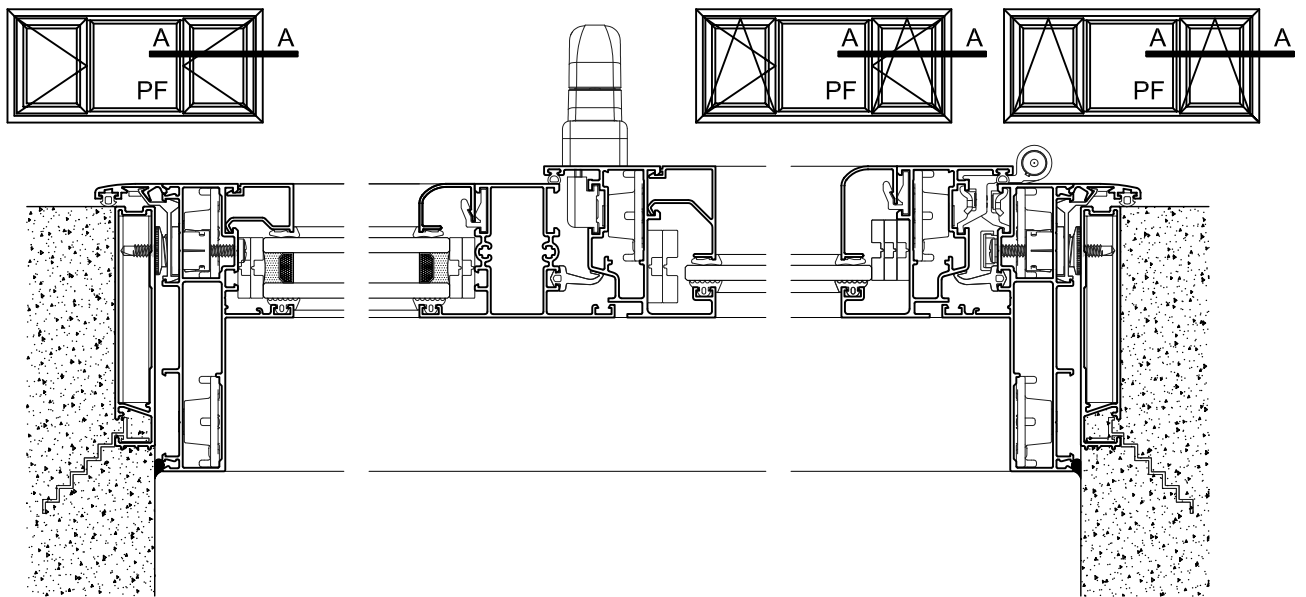

Escala 1:3

Tolerancia en Peso +/- 10%

Vista

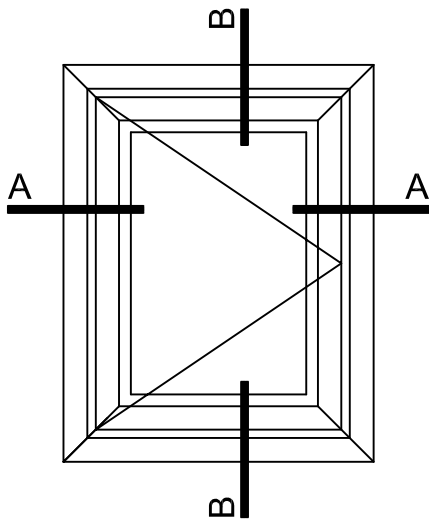

B-B Corte Vertical

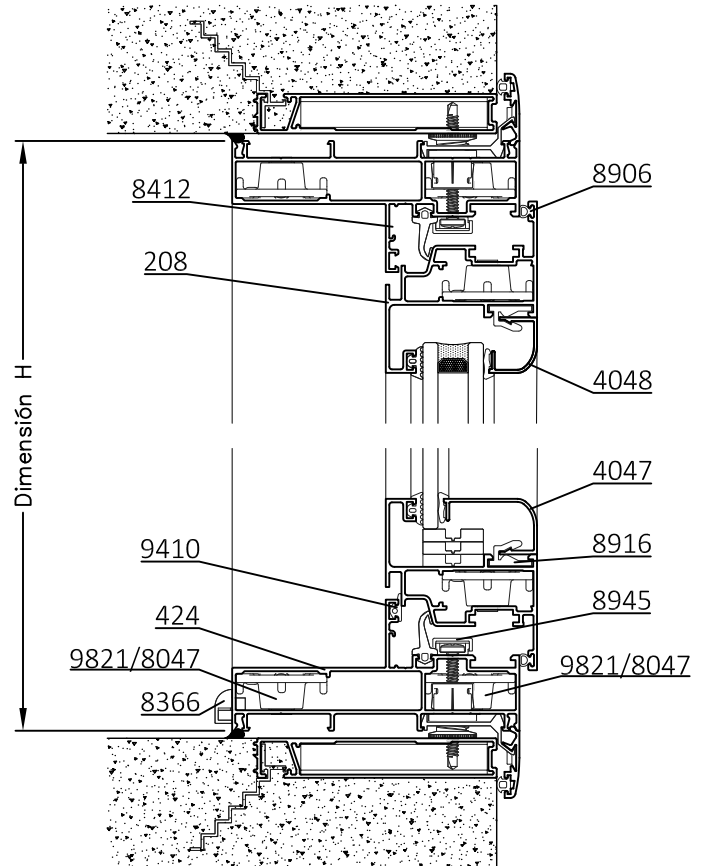

Opción Banderola

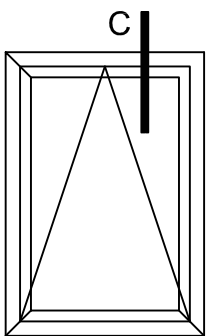

Corte C

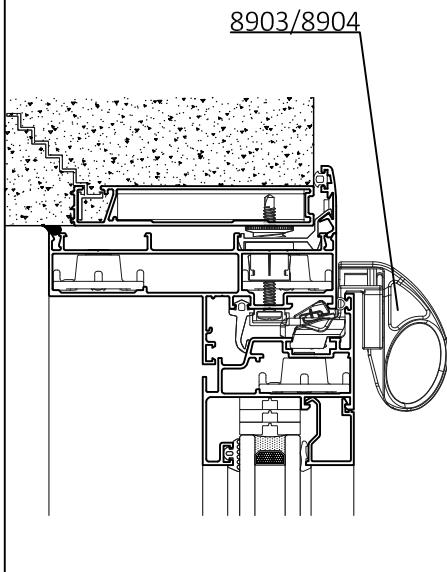

A-A Corte Horizontal

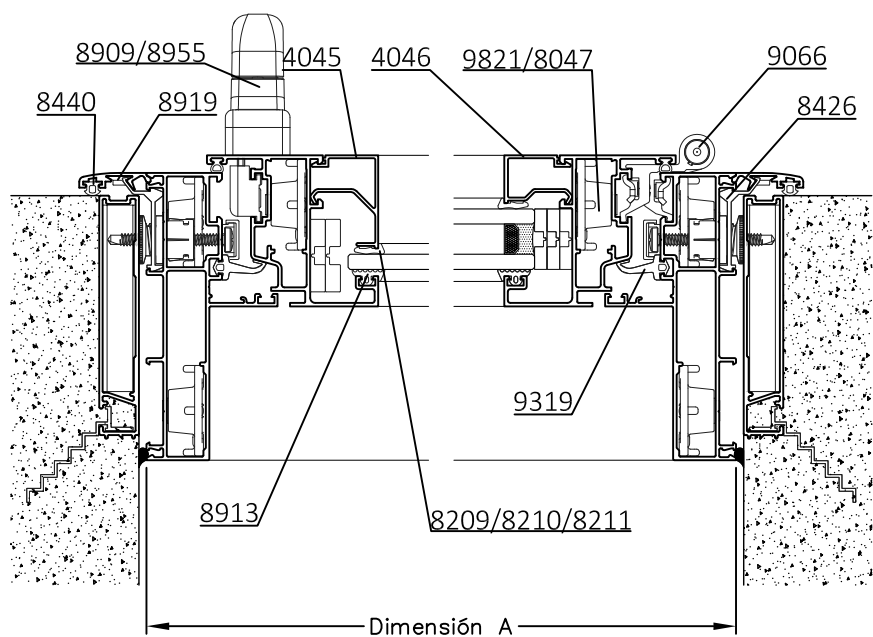



Escala 1:3

Tolerancia en Peso +/- 10%

50

09 - 2024

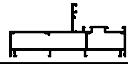
NIZA













Dimensiones de Corte				De Rebatir			Banderola		
Código	Peso Kg/m	Forma	Función	Cant.	Largo	Corte	Cant.	Largo	Corte
1110424	1,49		Marco	2	A	45° 45°	2	A	45° 45°
				2	H	45° 45°	2	H	45° 45°
9469	0,07(Varilla)		Pletina	2	S/F	90° 90°	-	-	-
1110208	1,06		Hoja	2	A-48	45° 45°	2	A-48	45° 45°
				2	H-48	45° 45°	2	H-48	45° 45°
4047/4048/ 4050/051/052/053	-	-	Contrav. con clip	2	A-140	45° 45°	2	A-140	45° 45°
				2	H-140	45° 45°	2	H-140	45° 45°
4045/4046/ 4049	-	-	Contrav. Recto	2	A-140	90° 90°	2	A-140	90° 90°
				2	H-184	90° 90°	2	H-184	90° 90°

Dimensiones de Corte Contramarco: pág. 3

Dimensiones de Corte Premarco: pág.4

S/F: Dimensiones de Corte según Falleba

\* Medidas en milímetros

Detalle de Accesorios				De Rebatir	Banderola
Ítem	Código	Descripción	Forma	Cantidad	Cantidad
Esc. de Armado	9821 8047	Esc. de Armado Marco y Hoja E-83		12 Unidades	12 Unidades
Clip	8916	Clip Contravidrios T-96		s/m	s/m
Burlete Vidrio	8913	Burlete de Acristalamiento B-68		2A + 2H	2A + 2H
Cuña Vidrio	8209	Cuña Chica		4A + 4H (2)	4A + 4H (2)
	8210	Cuña Mediana		2A + 2H (1)	2A + 2H (1)
	8211	Cuña Grande			
Burlete Hermetic.	8906	Burlete AEL europeo		2A + 2H	2A + 2H
	9320	Esq. Vulcanizado Burlete B-75		4 Unidades	4 Unidades
	9319	Burlete Cámara Compensada B-74		2A <sub>(a)</sub> + 2H <sub>(a)</sub>	2A <sub>(a)</sub> + 2H <sub>(a)</sub>
	9410	Burlete Marco doble contacto B-80		A	A
Cierre	8909	Falleba Prima H-47 con Kit		1 Unidad	-
	8955	Falleba Nova H-86 con Kit			
	8904	Traba Banderola H-52			
Brazo Sostén	8443	Brazo Sostén Banderola H-53	-	-	1 Par
Sostén de Hoja	8433	Sostén de Hoja H-44	-	1 Unidad	1 Unidad
Bisagra	8908	Bisagra H-61 de 2 piezas con Kit		2 Unidades	2 Unidades
Tapa Desagüe	8366	Tapa Desagüe T-69 T-131		2 Unidades	2 Unidades
Tapón Hermetic.	9722	Tapón de Hermeticidad Caja de Agua		2 Unidades	2 Unidades

s/m: según medida.

Accesorios Contramarco: pág. 3 Premarco: pág. 4

(\*) Para Anchos superiores a 800 milímetros se recomiendan 2 Unidades.

(a) Medida de Ancho (A) o Alto (H) surge de A-250mm o H-250mm

Vista

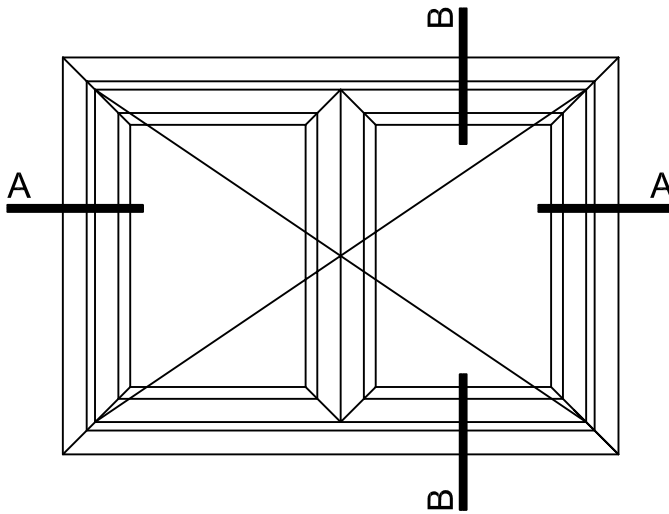



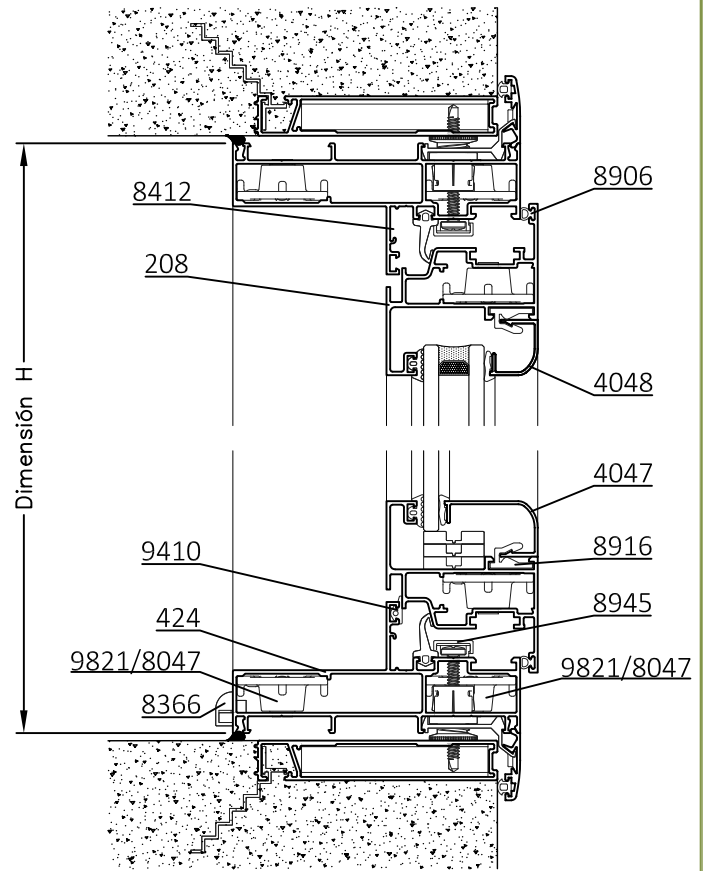

B-B Corte Vertical

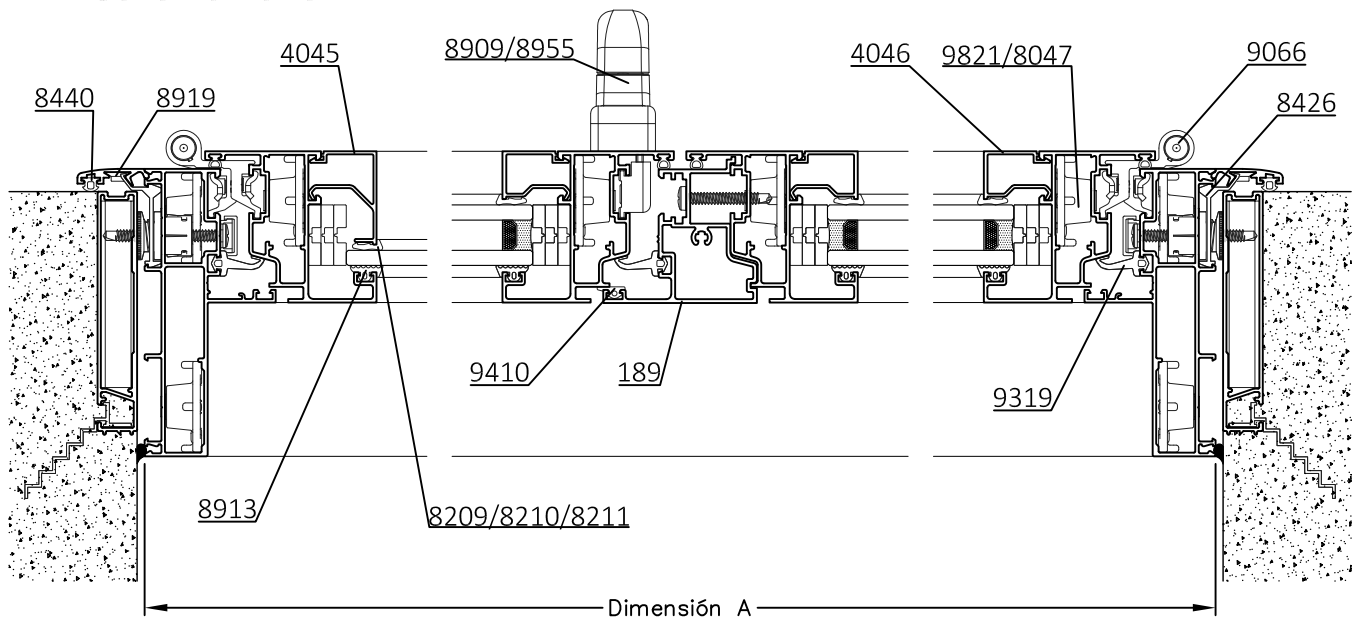

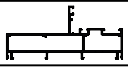
A-A Corte Horizontal















Dimensiones de Corte						
Código	Peso Kg/m	Forma	Función	Cant.	Largo	Corte
1110424	1,49		Marco	2	A	45° 45°
				2	H	45° 45°
Varilla 9469	0,07(Varilla)		Pletina	2	S/F	90° 90°
1110208			Hoja	2	A/2-27	45° 45°
				2	H-47	45° 45°
1110189	1,09		Inversor	1	H-113	90° 90°
4047/4048/ 4050/051/052/053	-	-	Contrav. con clip	2	A/2-119	45° 45°
				2	H-140	45° 45°
4045/4046/ 4049	-	-	Contrav. Recto	2	A/2-119	90° 90°
				2	H-184	90° 90°

Dimensiones de Corte Contramarco: pág. 3

S/F: Dimensiones de Corte según Falleba

Dimensiones de Corte Premarco: pág. 4

\* Medidas en milímetros

Detalle de Accesorios				De Rebatir
Ítem	Código	Descripción	Forma	Cantidad
Esc. de Armado	9821 8047	Esc. de Armado Marco y Hoja E-83		16 Unidades
Clip	8916	Clip Contravidrios T-96		s/m
Burlete Vidrio	8913	Burlete de Acristalamiento B-68		2A + 4H
Cuña Vidrio	8209	Cuña Chica		2A + 4H
	8210	Cuña Mediana		
	8211	Cuña Grande		
Burlete Hermetic.	8906	Burlete AEL europeo		2A + 3H
	9320	Esq. Vulcanizado Burlete B-75		4 Unidades
	9319	Burlete Cámara Compensada B-74		2A(a)+2H(a)+1H
Cierre	8909	Falleba Prima H-47 con Kit		1 Unidad
	8955	Falleba Nova H-86 con Kit		
Sostén de Hoja	8433	Sostén de Hoja H-44	-	1 Unidad
Traba Varilla	9129	Traba Varilla Doble H-78	-	2 Unidades
Pasador	9124	Pasador H-42 Giesse		2 Unidades
Bisagra	8908	Bisagra H-61 de 2 piezas con Kit		4 Unidades
Tapa Desagüe	8366	Tapa Desagüe T-69 T-131		2 Unidades
Tapón Inversor	9740	Tapón Inversor de Hoja T-119		1 Par
Tapón Hermetic.	9722	Tapón de Hermeticidad Caja de Agua		2 Unidades

s/m: según medida.

Accesorios Contramarco: pág. 3 Premarco: pág. 4

(a) Medida de Ancho (A) o Alto (H) surge de A-250mm o H-250mm

B-B Corte Vertical

Vista

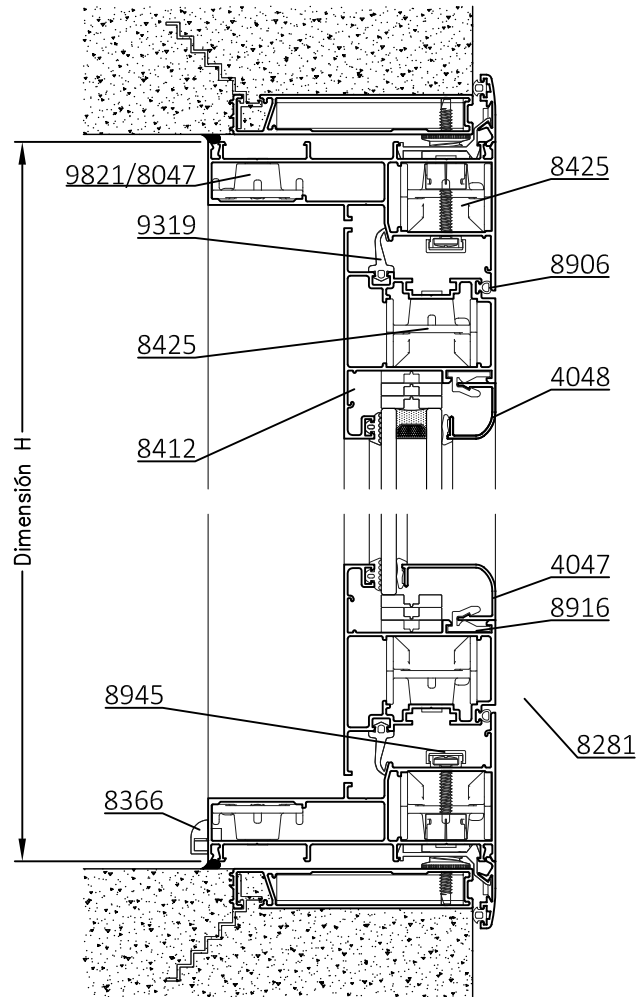
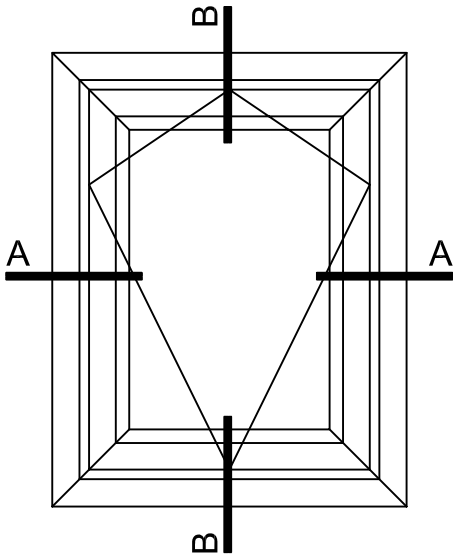

A-A Corte Horizontal

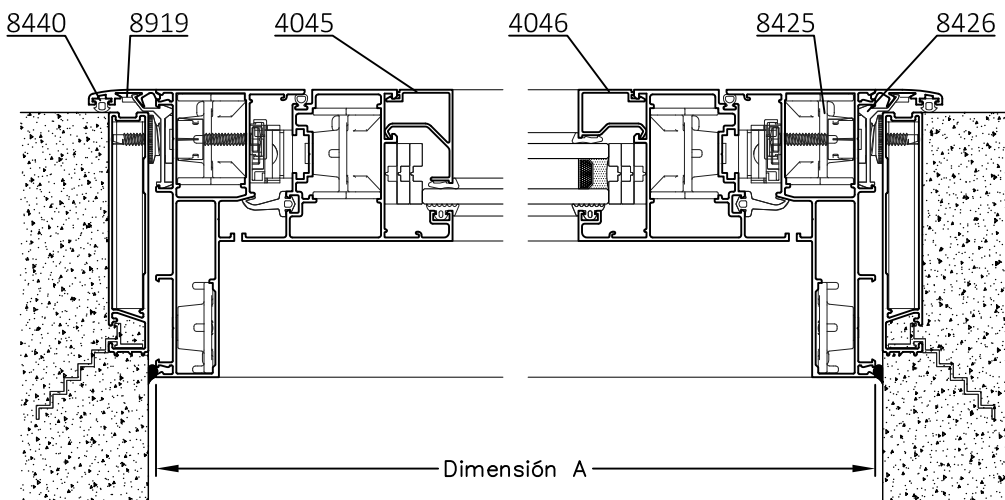

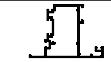











Dimensiones de Corte						
Código	Peso Kg/m	Forma	Función	Cant.	Largo	Corte
1110414	1,49		Marco	2	A	45° 45°
				2	H	45° 45°
1110735	1,25		Hoja	2	A-67	45° 45°
				2	H-67	45° 45°
4047/4048/ 4050/051/052/053	-	-	Contrav. con clip	2	A-190	45° 45°
				2	H-190	45° 45°
4045/4046/ 4049	-	-	Contrav. Recto	2	A-190	90° 90°
				2	H-234	90° 90°

Dimensiones de Corte Contramarco: pág. 3

\* Medidas en milímetros

Dimensiones de Corte Premarco: pág. 4

Detalle de Accesorios				
Ítem	Código	Descripción	Forma	Cantidad
Esc. de Armado	9821 8047	Esc. de Armado Marco E-83		4 Unidades
	8425	Esc. de Armado de Marco y Hoja E-70		8 Unidades
	8412	Esc. de Alineación Hoja Fuji 2013	-	8 Unidades
	8415	Esc. de Alineación Hoja y Marco E-62	-	
Clip	8916	Clip Contravidrios T-96		s/m
Cuña Vidrio	8209	Cuña Chica		2A + 2H
	8210	Cuña Mediana		
	8211	Cuña Grande		
Burlete Vidrio	8913	Burlete de Acristalamiento B-68		2A + 2H
Burlete Hermetic.	8906	Burlete AEL europeo		2A + 2H
Burlete Hermetic.	9319	Burlete Hermeticidad Exterior (B-74)		2A + 2H
Aldaba (a) (de aplicar)	8281	Aldaba CP25		1 Unidad (a)
	8475	Aldaba Mónaco		
Tijera	8464	Tijera de A°lº 259 mm. H(*) 750mm - 50 kg.		1 Par
	8460	Tijera de A°lº 412 mm. H(*) 1100mm-70 kg.		
	8463	Tijera de A°lº 558 mm. H(*) 1350mm-74 kg.		
	8471	Tijera de A°lº 660 mm. H(*) 2000mm-120 kg.		
	8411	Tijera de A°lº 262 mm. H(*) 750mm - 37 kg.		
	8412	Tijera de A°lº 415 mm. H(*) 1100mm-55 kg.		
	8413	Tijera de A°lº 567 mm. H(*) 1350mm-75 kg.		
8414	Tijera de A°lº 660 mm. H(*) 2000mm-100 kg.			
Tapón Hermetic.	9721	Tapón de Hermeticidad Caja de Agua		2 Unidades
Tapa Desagüe	8366	Tapa Desagüe T-69 T-131		2 Unidades

s/m: según medida.

Accesorios Contramarco: pág. 3 Premarco: pág. 4

(a): En hojas de 900 mm o más de ancho se aconseja utilizar 2 aldabas de cierre por hoja.

H(\*): Altura de Hoja.

Tijeras Cod.8460/8463/8464/8471 marca Cotsword.

Tijeras Cod.8411/8412/8413/8414 marca Storm.

Nota: En hojas de 1200 mm o más de alto se aconseja utilizar un limitador de apertura (Cód. 8481)

Vista

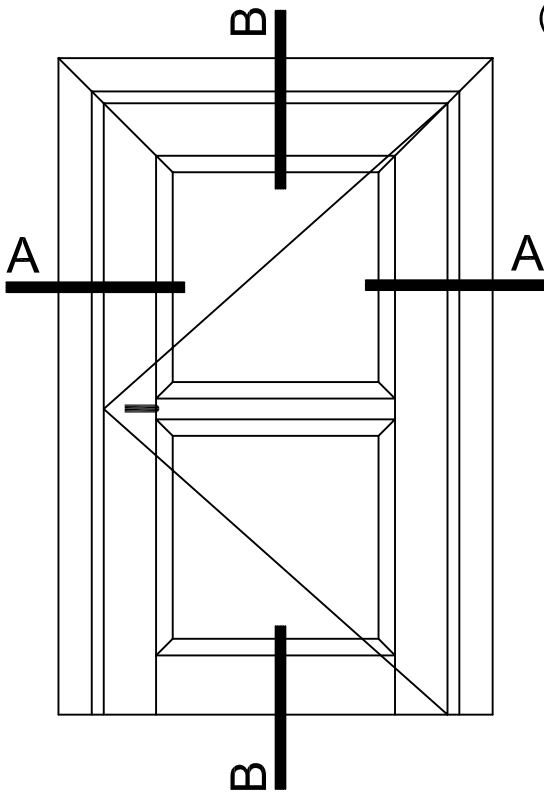

B-B Corte Vertical  
(Con Travesaño)

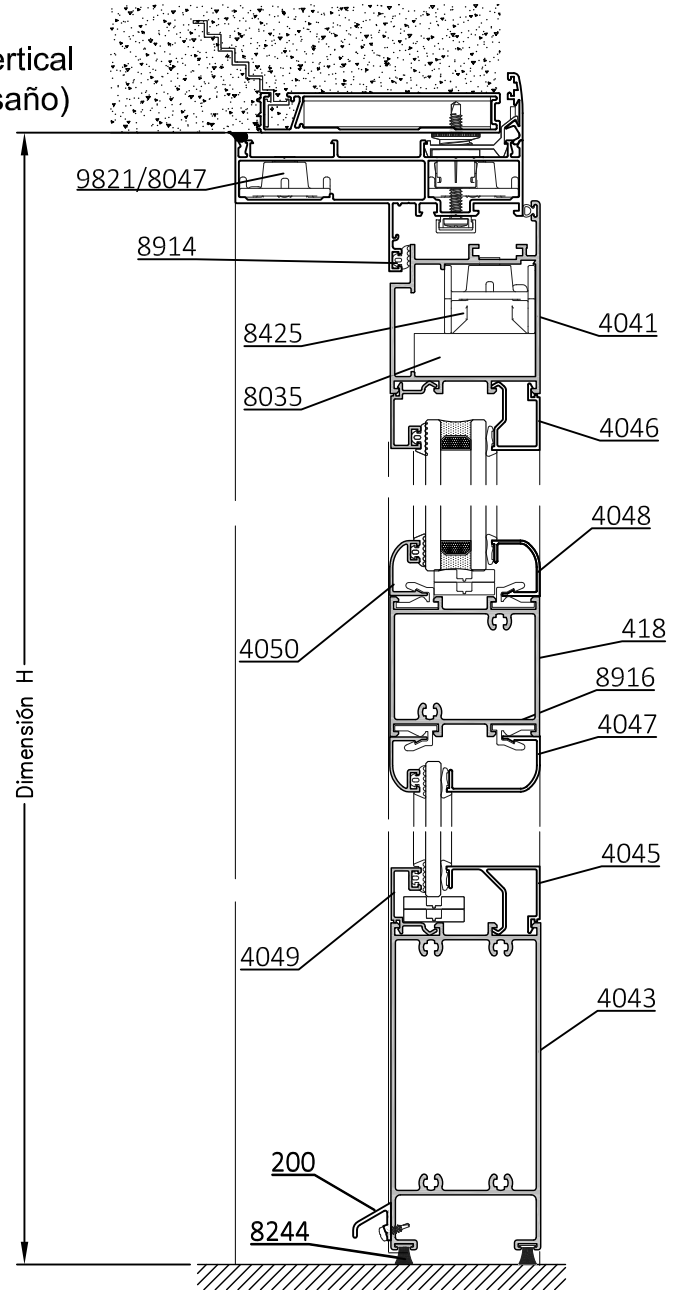

Opción de Zócalo Inferior  
con Umbral Transitable

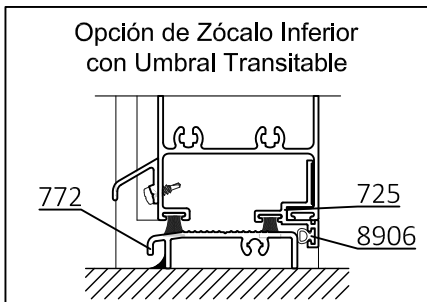



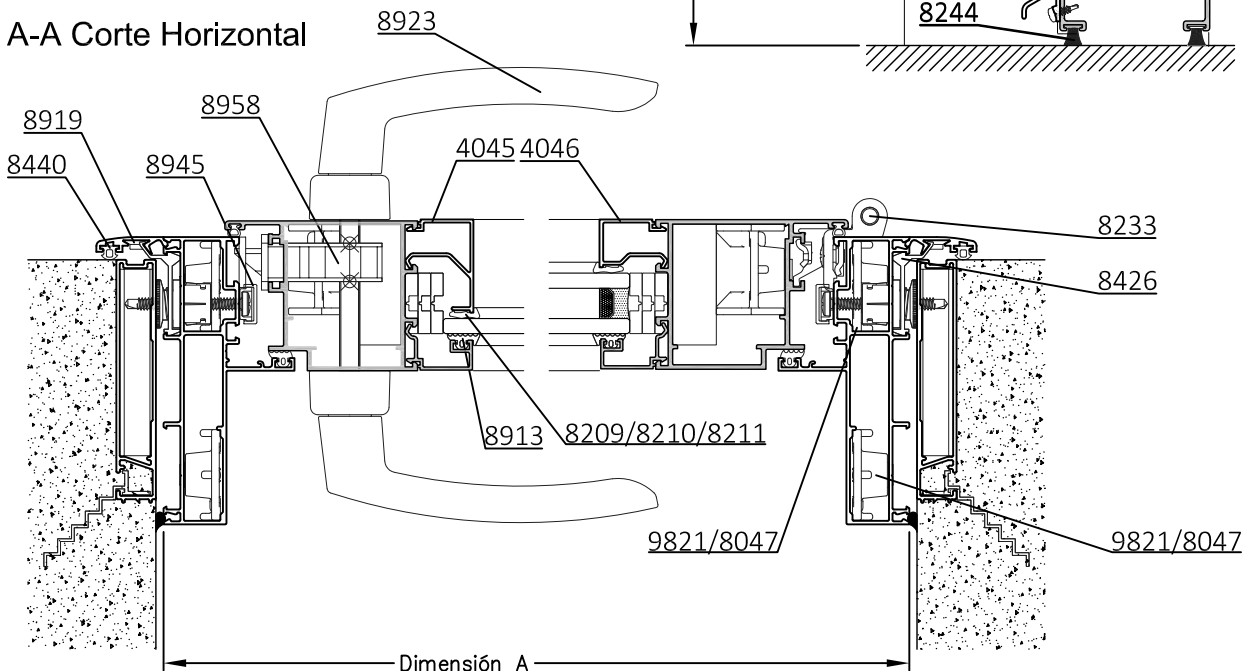

A-A Corte Horizontal

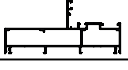

Escala 1:3

Tolerancia en Peso +/- 10%















Dimensiones de Corte			sin Umbral Transitable				Con Umbral		
Código	Peso Kg/m	Forma	Función	Cant.	Largo	Corte	Cant.	Largo	Corte
1110424	1,49		Marco	1	A	45° 45°	1	A	45° 45°
				2	H	45° 90°	2	H	45° 90°
4041	1,39		Hoja	1	A-47	45° 45°	1	A-47	45° 45°
				2	H-28	45° 90°	2	H-39	45° 90°
4042	1,40		Travesaño	1	A-201	90° 90°	1	A-201	90° 90°
4043	2,32		Zócalo	1	A-201	90° 90°	1	A-201	90° 90°
4047/4048/ 4050/051/052/053	-	-	Contrav int. con clip	2	A-201	45° 45°	2	A-201	45° 45°
				2	H-236	45° 45°	2	H-247	45° 45°
4045/4046	-	-	Contrav int. Recto	2	A-201	90° 90°	2	A-201	90° 90°
				2	H-280	90° 90°	2	H-291	90° 90°
4050	-	-	Contrav ext. Curvo	2	A-201	45° 45°	2	A-201	45° 45°
				2	H-236	45° 45°	2	H-247	45° 45°
4049	-	-	Contrav ext. Recto	2	A-201	90° 90°	2	A-201	90° 90°
				2	H-280	90° 90°	2	H-291	90° 90°
1060200	0,15		Bota agua	1	A-244	90° 90°	1	A-244	90° 90°

Dimensiones de Corte Contramarco: pág 3

\* Medidas en milímetros

Dimensiones de Corte Premarco: pág. 4

Detalle de Accesorios				S/Travesaño	C/Travesaño
Ítem	Código	Descripción	Forma	Cantidad	Cantidad
Esc. de Armado	9821 8047	Esc. de Armado Marco E-83		4 Unidades	
	8425	Esc. de Armado Hoja E-70		2 Unidades	
	8035	Escuadra Suplementaria Hoja de 48 mm		2 Unidades	
	8415	Esc. de Alineación Hoja y Marco E-62	-	4 Unidades	
Clip	8916	Clip Contravidrios T-96		s/m	s/m
Burlete Vidrio	8913	Burlete de Acristalamiento B-68		2A + 2H	4A + 2H
Cuña Vidrio	8209	Cuña Chica		2A + 2H	4A + 2H
	8210	Cuña Mediana			
	8211	Cuña Grande			
Burlete Hermetic.	8906	Burlete AEL europeo		1A + 2H	
	8914	Burlete Gabi III		1A + 2H	
Tapa Tornillo	8431	Tapa Cabeza de Tornillo T-100	-	8 Unidades	8 U. + 4 U. x Travesaño
Picaporte	8923	Manija Prima H-93		1 Unidad	
Cerradura	8958	Cerradura H-51 Kallay 2006		1 Unidad	
Bisagra	8233	Bisagra de 3 alas H-62		3 Unidades	
Felpa	8244	Felpa de 7x8 c/Fin Seal		2A	
Tornillos	8368	Tornillo Parker Parte I		8 Unidades	8 U. + 4 U. x Travesaño

s/m: según medida.

Accesorios Contramarco: pág. 3 Premarco: pág. 4

**B-B Corte Vertical  
(Con Travesaño)**

Vista

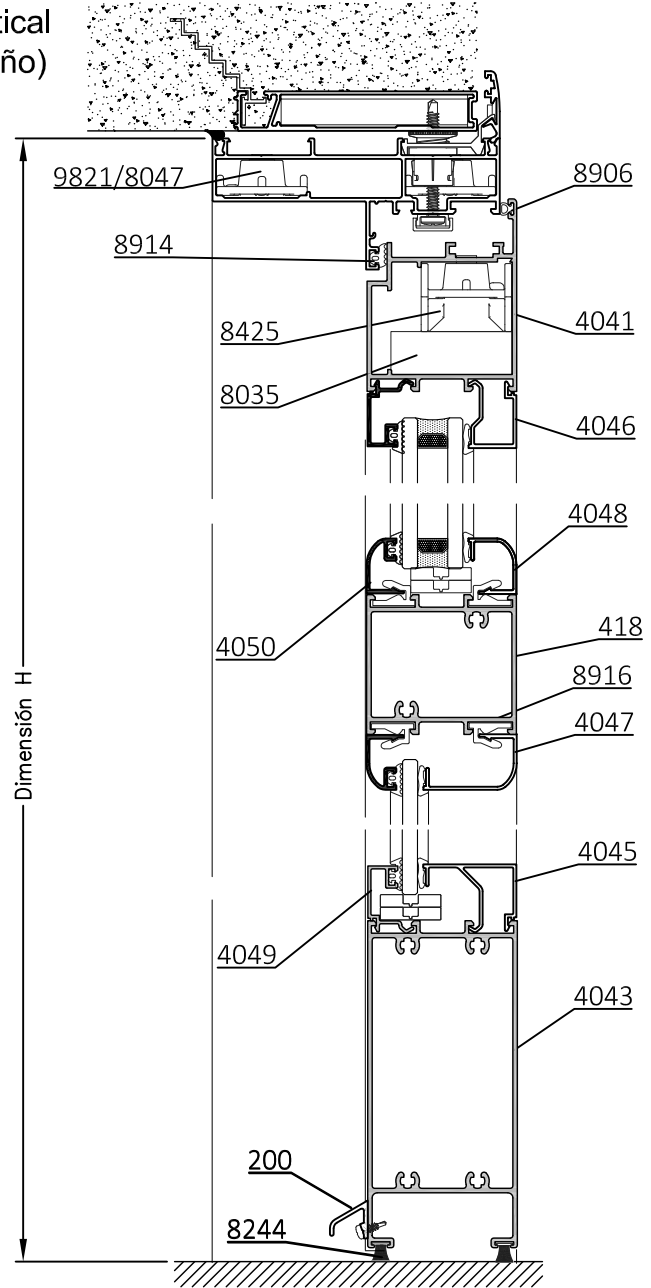
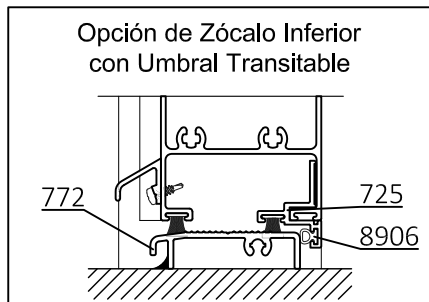
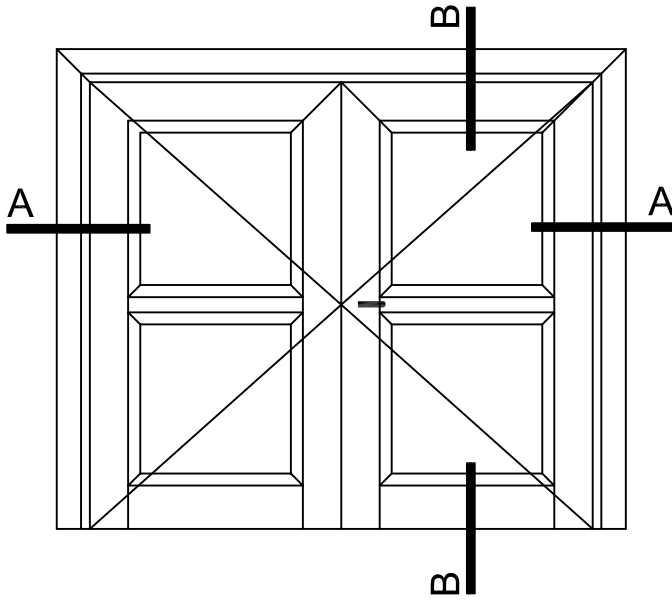

**A-A Corte Horizontal**

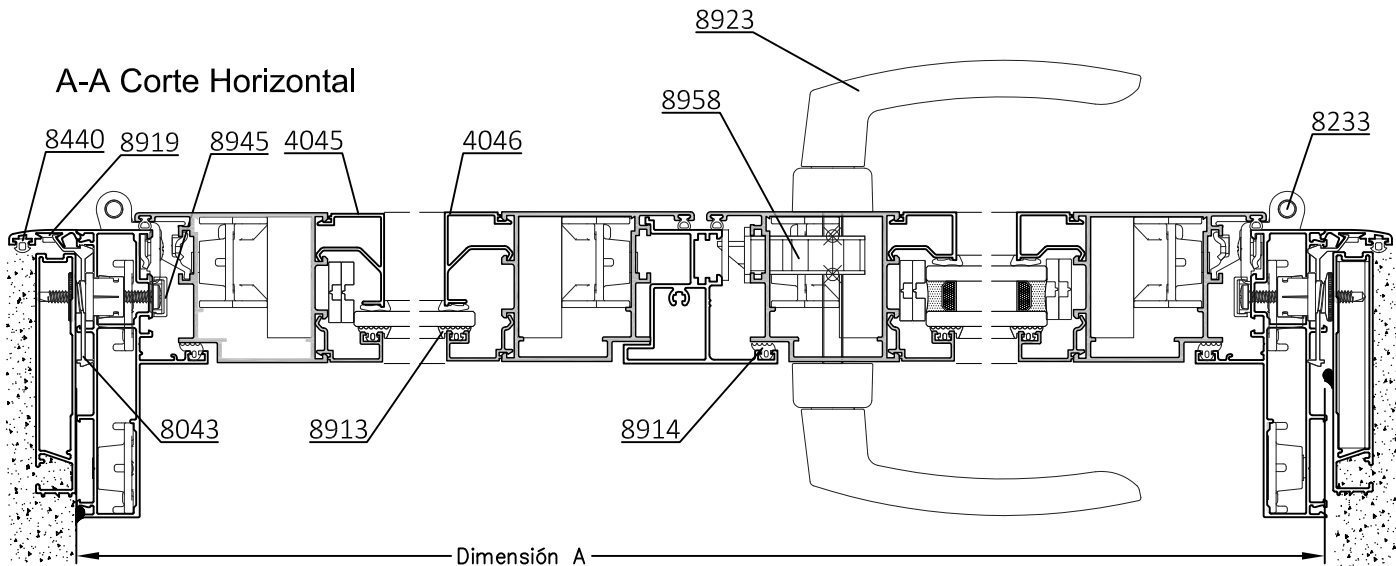







Escala 1:3

Tolerancia en Peso +/- 10%

58

09 - 2024















NIZA

Dimensiones de Corte			sin Umbral Transitable				Con Umbral		
Código	Peso Kg/m	Forma	Función	Cant.	Largo	Corte	Cant.	Largo	Corte
1110424	1,49		Marco	1	A	45° 45°	1	A	45° 45°
				2	H	45° 90°	2	H	45° 90°
4041	1,39		Hoja	2	A/2-26	45° 45°	2	A/2-26	45° 45°
				4	H-28	45° 90°	4	H-39	45° 90°
4042	1,40		Travesaño	1	A/2-180	90° 90°	1	A/2-180	90° 90°
4043	2,32		Zócalo	2	A/2-180	90° 90°	2	A/2-180	90° 90°
4044	1,04		Inversor	1	H-61	90° 90°	1	H-72	90° 90°
4047/4048/ 4050/051/052/053	-	-	Contrav int. con clip	2	A-201	45° 45°	2	A-201	45° 45°
				2	H-236	45° 45°	2	H-247	45° 45°
4045/4046	-	-	Contrav int. Recto	2	A-201	90° 90°	2	A-201	90° 90°
				2	H-280	90° 90°	2	H-291	90° 90°
4050	-	-	Contrav ext. Curvo	2	A-201	45° 45°	2	A-201	45° 45°
				2	H-236	45° 45°	2	H-247	45° 45°
4049	-	-	Contrav ext. Recto	2	A-201	90° 90°	2	A-201	90° 90°
				2	H-280	90° 90°	2	H-291	90° 90°
1060200	0,15		Bota agua	1	A-244	90° 90°	1	A-244	90° 90°

Dimensiones de Corte Contramarco: pág. 3

\* Medidas en milímetros

Dimensiones de Corte Premarco: pág. 4

Detalle de Accesorios				S/Travesaño	C/Travesaño
Ítem	Código	Descripción	Forma	Cantidad	Cantidad
Esc. de Armado	9821 8047	Esc. de Armado Marco E-83		4 Unidades	
	8425	Esc. de Armado Hoja E-70		4 Unidades	
	E-80	Escuadra Suplementaria Hoja de 47.9 mm		4 Unidades	
	8415	Esc. de Alineación Marco y Hoja E-62	-	6 Unidades	
Clip	8916	Clip Contravidrios T-96		s/m	s/m
Burlete Vidrio	8913	Burlete de Acristalamiento B-68		2A + 4H	4A + 4H
Cuña Vidrio	8209	Cuña Chica		2A + 4H	
	8210	Cuña Mediana		4A + 4H	
	8211	Cuña Grande		4A + 4H	
Burlete Hermetic.	8906	Burlete AEL europeo		1A + 3H	1A + 3H
	8914	Burlete Gabi III		1A + 3H	1A + 3H
Tapa Tornillo	8431	Tapa Cabeza de Tornillo T-100	-	16 Unidades	16 U. + 8 U. x Travesaño
Picaporte	8923	Manija Prima H-93		1 Unidad	1 Unidad
Cerradura	8958	Cerradura H-51 Kallay 2006		1 Unidad	1 Unidad
Bisagra	8233	Bisagra de 3 alas H-62		6 Unidades	6 Unidades
Felpa	8244	Felpa de 7x8		2A	2A
Tornillos	8368	Tornillo Parker Parte I		16 Unidades	16 U. + 8 U. x Travesaño
Pasador	9124	Pasador H-42 Giesse		2 Unidad	
	9217	Pasador Totem 18mm.		2 Unidad	
Tapón Inversor	9741	Tapón Inversor de Hoja de puerta T-120		1 Par	1 Par

s/m: según medida.

Accesorios Contramarco: pág. 3 Premarco: pág. 4

Tolerancia en Peso +/- 10%

59

09 - 2024

NIZA

Vista

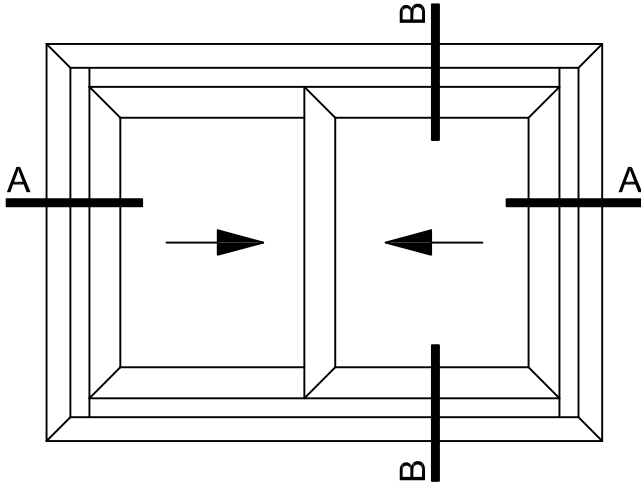

B-B Corte Vertical

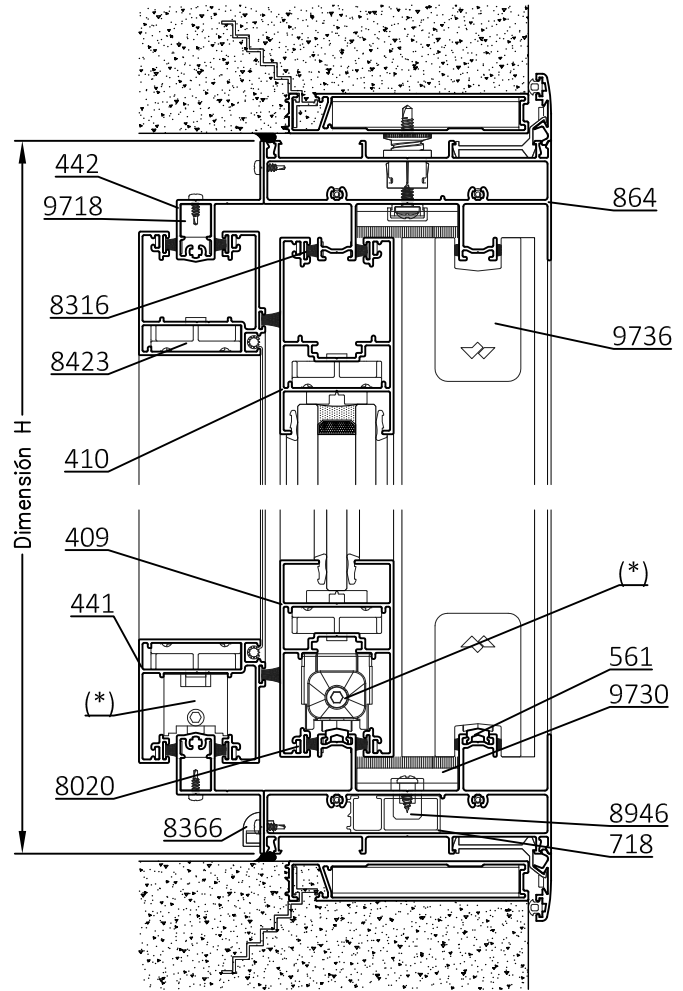

A-A Corte Horizontal

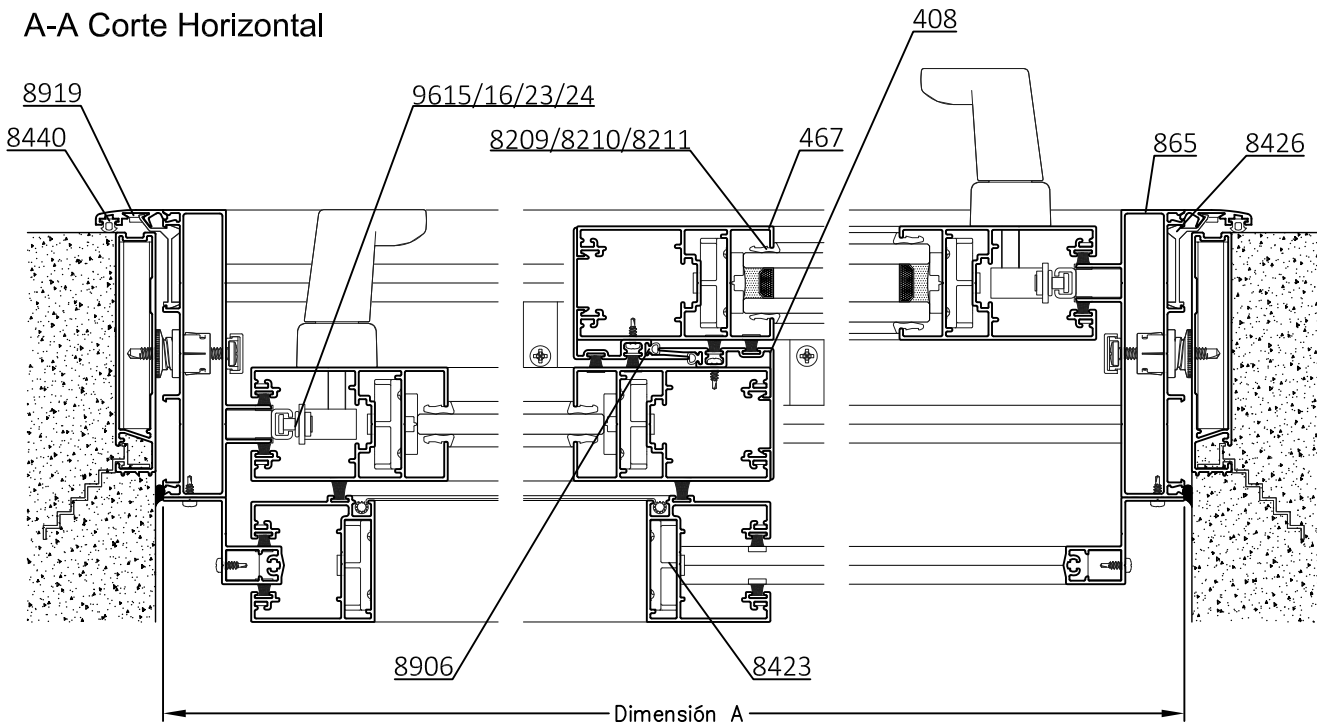





Escala 1:3

Tolerancia en Peso +/- 10%

60

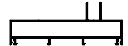

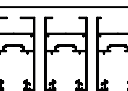

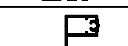
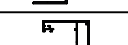











09 - 2024

NIZA

Dimensiones de Corte						
Código	Peso Kg/m	Forma	Función	Cant.	Largo	Corte
1110865	1,29		Jamba	2	H	90° 90°
1110864	1,79		Umbral Dintel	2	A-50	90° 90°
1060561	0,09		Guía Inf. Marco	2	A-50	90° 90°
1110409 (V.S) 1110467 (D.V.H) 1110410 (D.V.H)	1,34 1,29 1,26		Hoja	4	A/2+4	45° 45°
				4	H-78	45° 45°
1110408	0,46		Solapa cruce	2	H-78	90° 90°
1110442	0,51		Guía mosq.	2	A	45° 45°
				2	H	45° 45°
1110441	1,02		Hoja mosq.	2	A/2+4	45° 45°
				2	H-78	45° 45°

\* Medidas en milímetros  
s/m: según medida.

Corte Contramarco: pág. 3  
Corte Premarco: pág. 4

Detalle de Accesorios				
Ítem	Código	Descripción	Forma	Cantidad
Escuadra armado	8423	Escuadra armado hojas E-69		12 Unidades
	9718	Escuadra guía mosquitero	-	4 Unidades
Tornillo	8368	Tornillo Parker Parte I		8 Unidades
Cuña Vidrio	8209	Cuña Chica		4A + 8H
	8210	Cuña Mediana		
	8211	Cuña Grande		
Burlete Hermetic.	8906	Burlete AEL europeo solapa de cruce		2H
Felpa	8316	Felpa de Polipropileno 7 x 6 mm.		6A + 14H
Cierre Multipunto	9623	Mec. 2 Puntos e:7,5 mm de 400 mm p/ 4 cunas		2 Unidades
	9615	Mec. 2 Puntos e:7,5 mm de 600 mm p/ 6 cunas		
	9624	Mec. 2 Puntos e:7,5 mm de 1000 mm p/ 6 cunas		
	9616	Mec. 4 Puntos e:7,5 mm de 1200 mm p/ 8 cunas		
	9618	Cuna 18 mm mecanismo multipunto		s/m
	9599	Suplemento de cuna multipunto 6 mm		s/m
	9600	Suplemento cerradero JN multipunto		s/m
9440	Manijas Acodadas Modelo SR Izq / Der (par)	-	1 Unidad	
Rodamientos	9974	Rueda simple JN 80 Kg hoja R-46		4 Unidades
	8125	Rueda simple Carrera 100 Kg hoja R-46		
	8140	Rueda simple Pabose 150 Kg hoja R-46		
	9975	Rueda doble JN 180 Kg hoja R-47		
	8126	Rueda doble Carrera 200 Kg hoja R-47		
	8141	Rueda doble Pabose 300 Kg hoja R-47		
8932	Rueda simple Torino 40 kg hoja p/ mosqu.	-	2 Unidades	
Tope Central y Lat	9736	Tope Parante Central T-156		4 Unidades
	9735	Tope Parante Lateral T-165		4 Unidades
Cruce de Hoja	9730	Cruce de Hoja hoja 45° T-160		2 Unidades
Boca Desagüe	8946	Boca Desagüe T-94 T-130		s/m
Tapa Desagüe	8366	Tapa Desagüe T-69 T-131		2 Unidades
Junta estanqueidad	9732	Junta de estanqu. marco corr. 2 guías T-162		2 Pares

Vista

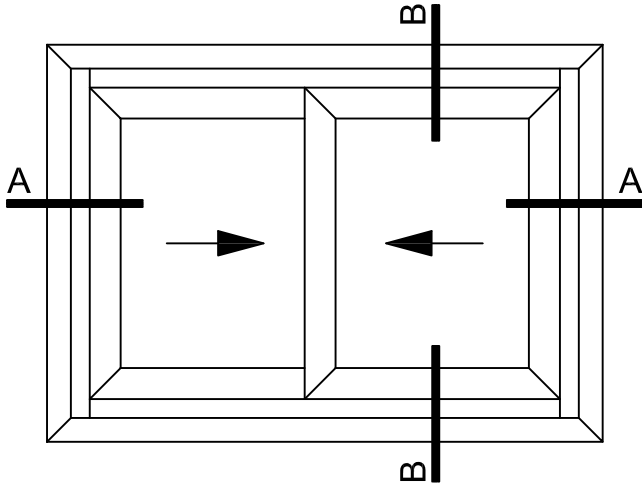

B-B Corte Vertical

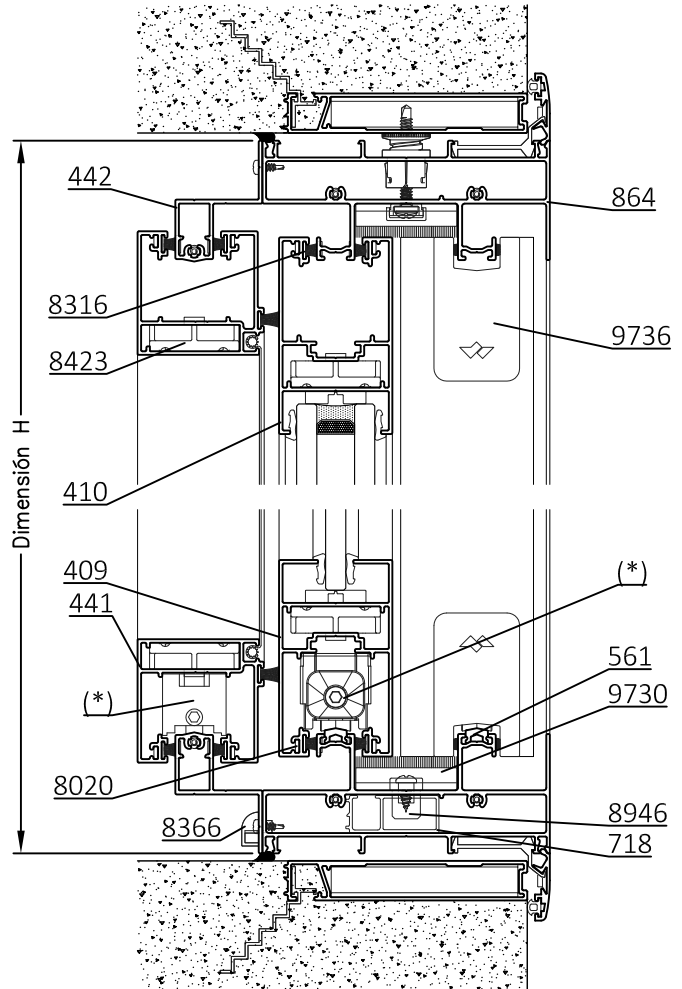



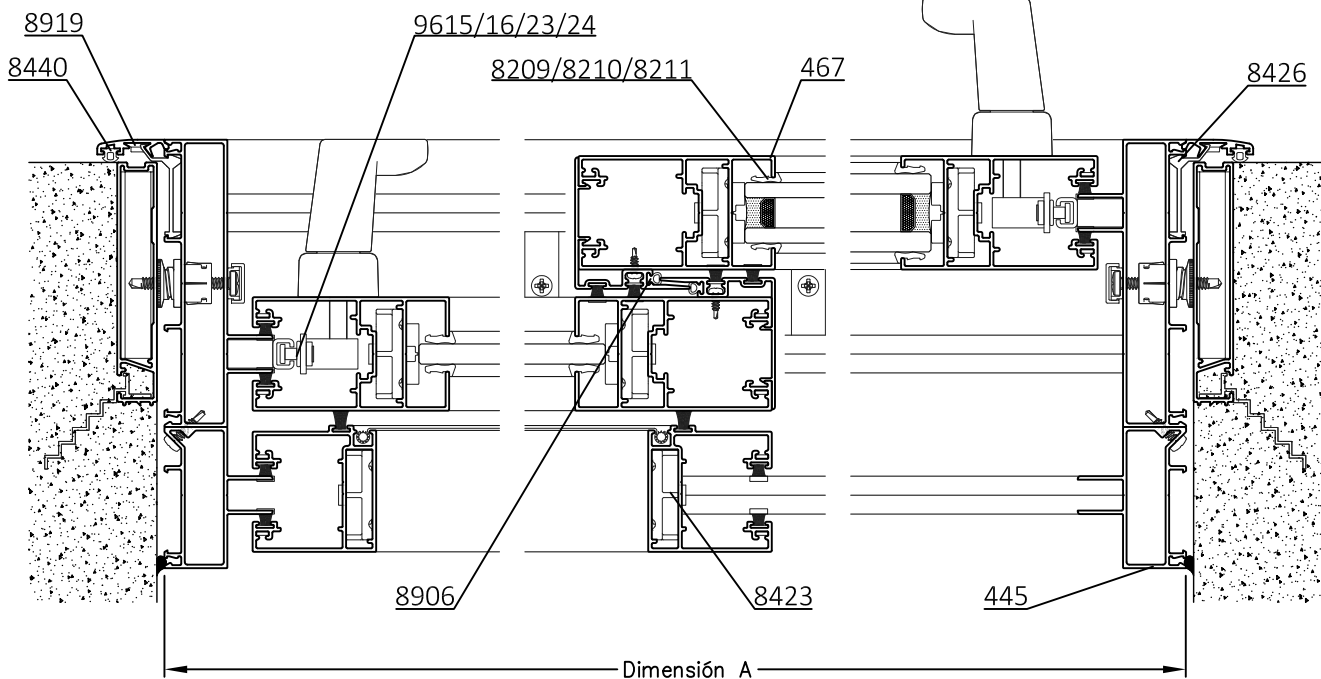



A-A Corte Horizontal

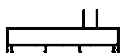
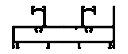

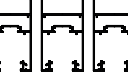

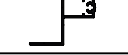













Escala 1:3

Tolerancia en Peso +/- 10%

Dimensiones de Corte						
Código	Peso Kg/m	Forma	Función	Cant.	Largo	Corte
1110865	1,29		Jamba	2	H	90° 90°
1110864	1,79		Umbral Dintel	2	A-50	90° 90°
1110561	0,09		Guía Inf. Marco	2	A-50	90° 90°
1110409 (V.S) 1110467 (D.V.H) 1110410 (D.V.H)	1,34 1,29 1,26		Hoja	4	A/2+4	45° 45°
				4	H-78	45° 45°
1110408	0,46		Solapa cruce	2	H-78	90° 90°
1110445	0,82		Guía mosq.	2	H	90° 90°
1110442	0,51		Guía mosq.	2	A	90° 90°
1110441	1,02		Hoja mosq.	2	A/2+4	45° 45°
				2	H-78	45° 45°

\* Medidas en milímetros  
s/m: según medida.

Corte Contramarco: pág. 3  
Corte Premarco: pág. 4

Detalle de Accesorios				
Ítem	Código	Descripción	Forma	Cantidad
Escuadra armado	8423	Escuadra armado hojas E-69		12 Unidades
Tornillo	8368	Tornillo Parker Parte I		12 Unidades
Cuña Vidrio	8209	Cuña Chica		4A + 8H
	8210	Cuña Mediana		
	8211	Cuña Grande		
Burlete Hermetic.	8906	Burlete AEL europeo solapa de cruce		2H
Felpa	8316	Felpa de Polipropileno 7 x 6 mm.		6A + 14H
Cierre Multipunto	9623	Mec. 2 Puntos e:7,5 mm de 400 mm p/ 4 cunas		2 Unidades
	9615	Mec. 2 Puntos e:7,5 mm de 600 mm p/ 6 cunas		
	9624	Mec. 2 Puntos e:7,5 mm de 1000 mm p/ 6 cunas		
	9616	Mec. 4 Puntos e:7,5 mm de 1200 mm p/ 8 cunas		
	9618	Cuna 18 mm mecanismo multipunto		s/m
	9599	Suplemento de cuna multipunto 6 mm		s/m
	9600	Suplemento cerradero JN multipunto		s/m
9440	Manijas Acodadas Modelo SR Izq / Der (par)	-	-	1 Unidad
Rodamientos	9974	Rueda simple JN 80 Kg hoja R-46		4 Unidades
	8125	Rueda simple Carrera 100 Kg hoja R-46		
	8140	Rueda simple Pabose 150 Kg hoja R-46		
	9975	Rueda doble JN 180 Kg hoja R-47		
	8126	Rueda doble Carrera 200 Kg hoja R-47		
	8141	Rueda doble Pabose 300 Kg hoja R-47		
8962	Rueda simple Torino 40 kg hoja p/ mosqu.	-	2 Unidades	
Tope Central y Lat	9736	Tope Parante Central T-156		4 Unidades
	9735	Tope Parante Lateral T-165		4 Unidades
Cruce de Hoja	9730	Cruce de Hoja hoja 45° T-160		2 Unidades
Boca Desagüe	8946	Boca Desagüe T-94 T-130		s/m
Tapa Desagüe	8366	Tapa Desagüe T-69 T-131		2 Unidades
Junta estanqueidad	9732	Junta de estanqu. marco corr. 2 guías T-162		2 Pares

Vista

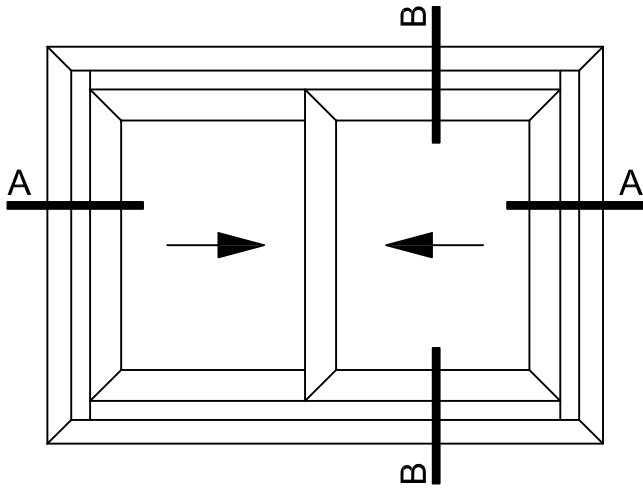

B-B Corte Vertical

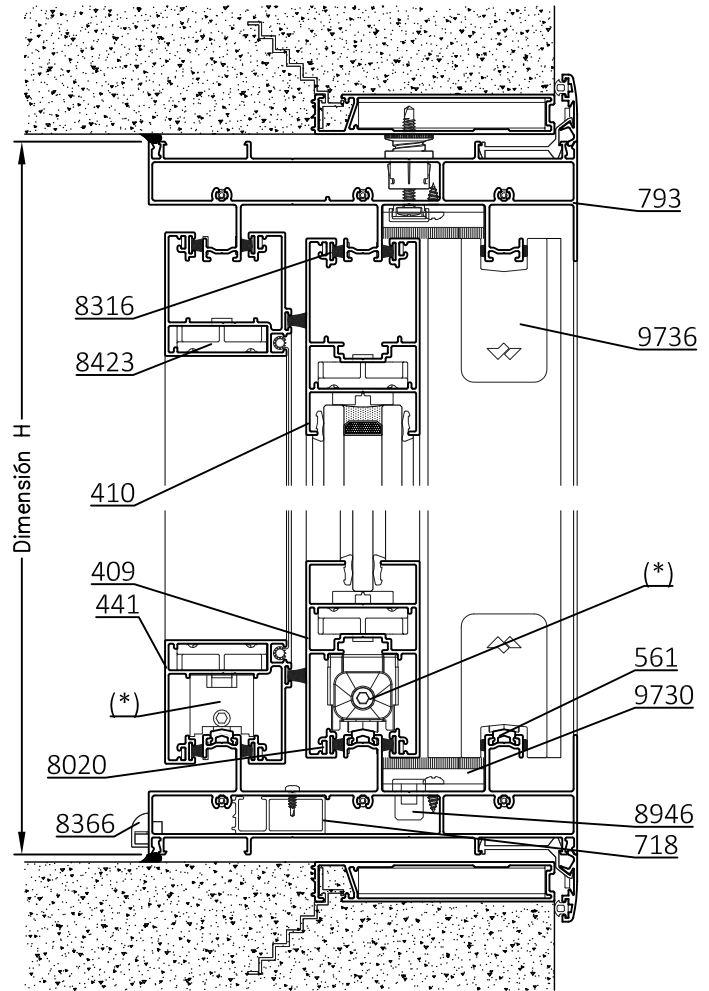



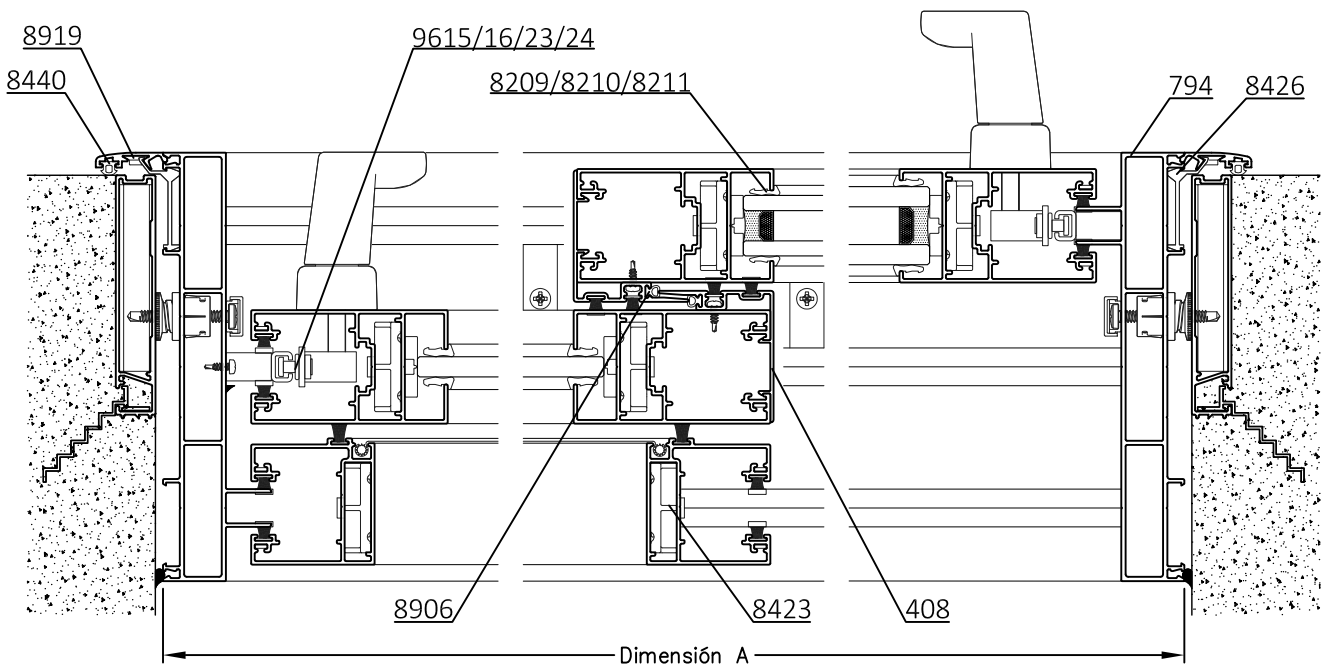

A-A Corte Horizontal



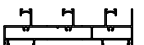

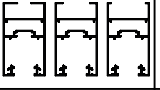













Escala 1:3  
Tolerancia en Peso +/- 10%



Dimensiones de Corte						
Código	Peso Kg/m	Forma	Función	Cant.	Largo	Corte
1110794	1,29		Jamba	2	H	90° 90°
1110793	1,79		Umbral Dintel	2	A-50	90° 90°
1110469	0,18		U Jamba	1	H-95	90° 90°
1060561	0,09		Guía Inf. Marco	3	A-50	90° 90°
1110409 (V.S) 1110467 (D.V.H) 1110410 (D.V.H)	1,34 1,29 1,26		Hoja	4 4	A/2+4 H-78	45° 45° 45° 45°
1110408	0,46		Solapa cruce	2	H-78	90° 90°
1110441	1,02		Hoja mosq.	2	A/2+4	45° 45°
				2	H-78	45° 45°

\* Medidas en milímetros  
s/m: según medida.

Corte Contramarco: pág. 3  
Corte Premarco: pág. 4

Detalle de Accesorios					
Ítem	Código	Descripción	Forma	Cantidad	
Escuadra armado	8423	Escuadra armado hojas E-69		12 Unidades	
Tornillo	8368	Tornillo Parker Parte I		12 Unidades	
Cuña Vidrio	8209	Cuña Chica		4A + 8H	
	8210	Cuña Mediana			
	8211	Cuña Grande			
Burlete Hermetic. Felpa	8906	Burlete AEL europeo solapa de cruce		2H	
	8316	Felpa de Polipropileno 7 x 6 mm.		6A + 14H	
Cierre Multipunto	9623	Mec. 2 Puntos e:7,5 mm de 400 mm p/ 4 cunas		2 Unidades	
	9615	Mec. 2 Puntos e:7,5 mm de 600 mm p/ 6 cunas			
	9624	Mec. 2 Puntos e:7,5 mm de 1000 mm p/ 6 cunas			
	9616	Mec. 4 Puntos e:7,5 mm de 1200 mm p/ 8 cunas			
		9618	Cuna 18 mm mecanismo multipunto		s/m
		9599	Suplemento de cuna multipunto 6 mm		s/m
		9600	Suplemento cerradero JN multipunto		s/m
	9440	Manijas Acodadas Modelo SR Izq / Der (par)	-	1 Unidad	
Rodamientos	9974	Rueda simple JN 80 Kg hoja R-46		4 Unidades	
	8125	Rueda simple Carrera 100 Kg hoja R-46			
	8140	Rueda simple Pabose 150 Kg hoja R-46			
	9975	Rueda doble JN 180 Kg hoja R-47			
	8126	Rueda doble Carrera 200 Kg hoja R-47			
	8141	Rueda doble Pabose 300 Kg hoja R-47			
	8962	Rueda simple Torino 40 kg hoja p/ mosqu.	-	2 Unidades	
Tope Central y Lat	9736	Tope Parante Central T-156		4 Unidades	
	9735	Tope Parante Lateral T-165		4 Unidades	
Cruce de Hoja	9730	Cruce de Hoja hoja 45° T-160		2 Unidades	
Boca Desagüe	8946	Boca Desagüe T-94 T-130		s/m	
Tapa Desagüe	8366	Tapa Desagüe T-69 T-131		2 Unidades	
Junta estanqueidad	9733	Junta de estanqu. marco corr. 3 guías T-163		2 Pares	

**B-B Corte Vertical**

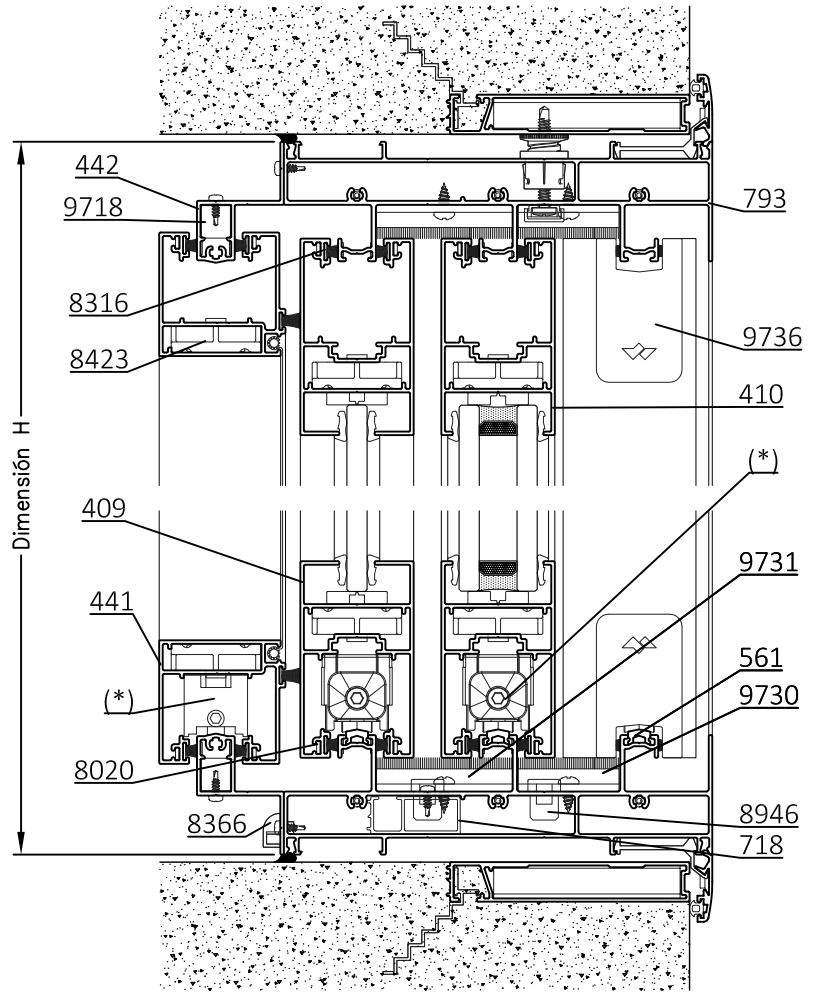
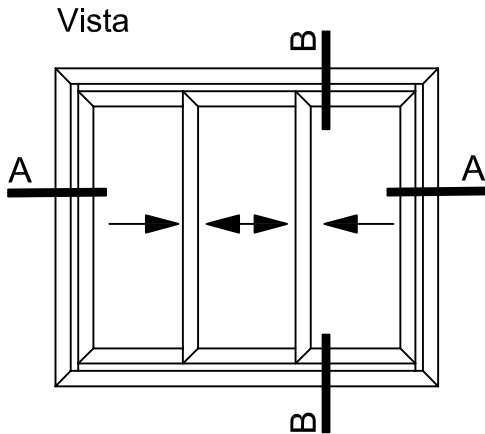



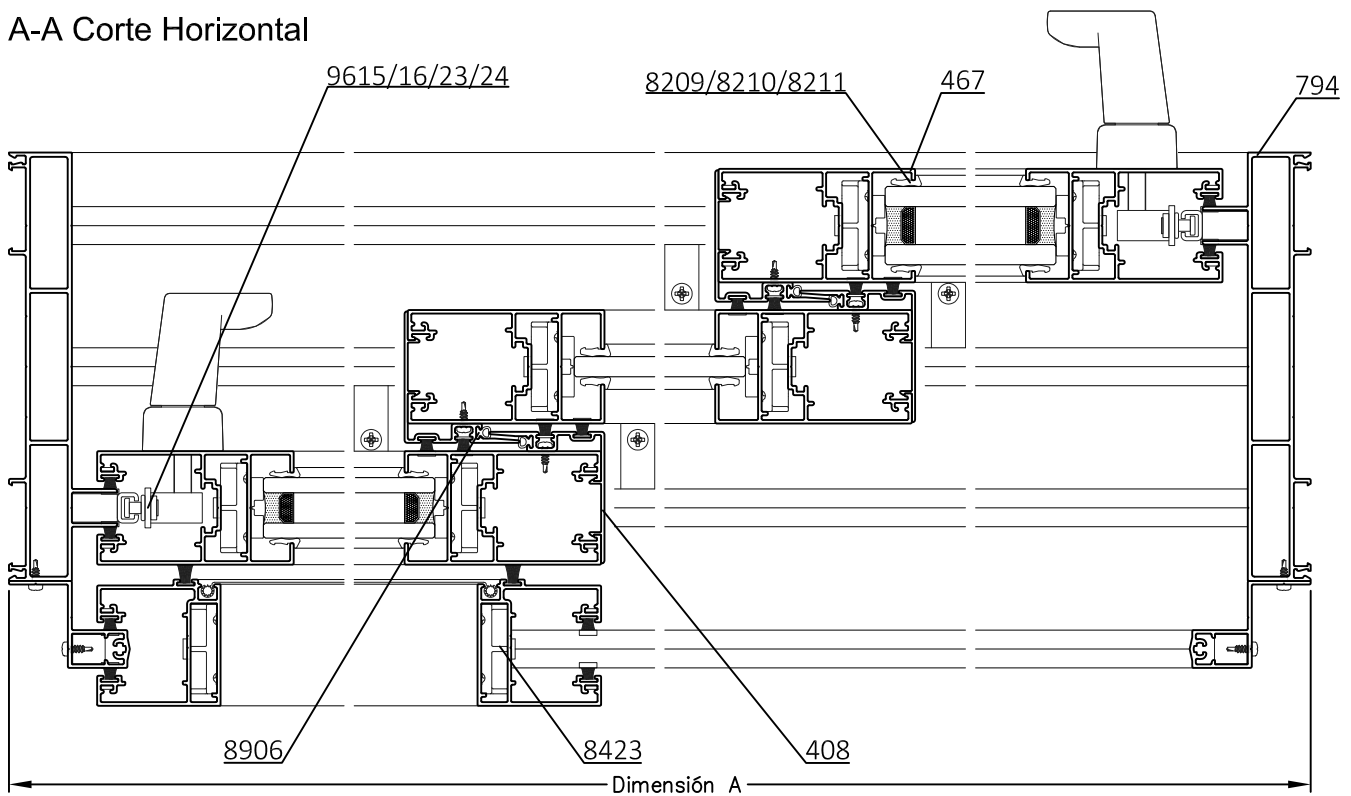







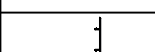











**A-A Corte Horizontal**



Escala 1:3

Tolerancia en Peso +/- 10%

Dimensiones de Corte						
Código	Peso Kg/m	Forma	Función	Cant.	Largo	Corte
1110794	2,14		Jamba	2	H	90° 90°
1110793	2,54		Umbral Dintel	2	A-50	90° 90°
1110561	0,09		Guía Inf. Marco	3	A-50	90° 90°
1110409 (V.S) 1110467 (D.V.H) 1110410 (D.V.H)	1,34 1,29 1,26		Hoja	6	A/3+28	45° 45°
				6	H-78	45° 45°
1110408	0,46		Solapa cruce	4	H-78	90° 90°
1110442	0,51		Guía mosq.	2	A	45° 45°
				2	H	45° 45°
	1,02		Hoja mosq.	2	A/3+28	45° 45°
				2	H-78	45° 45°





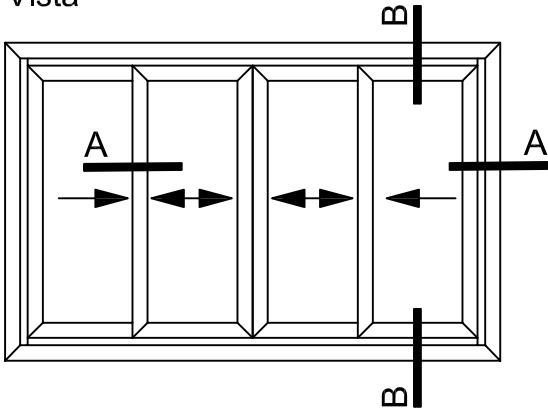

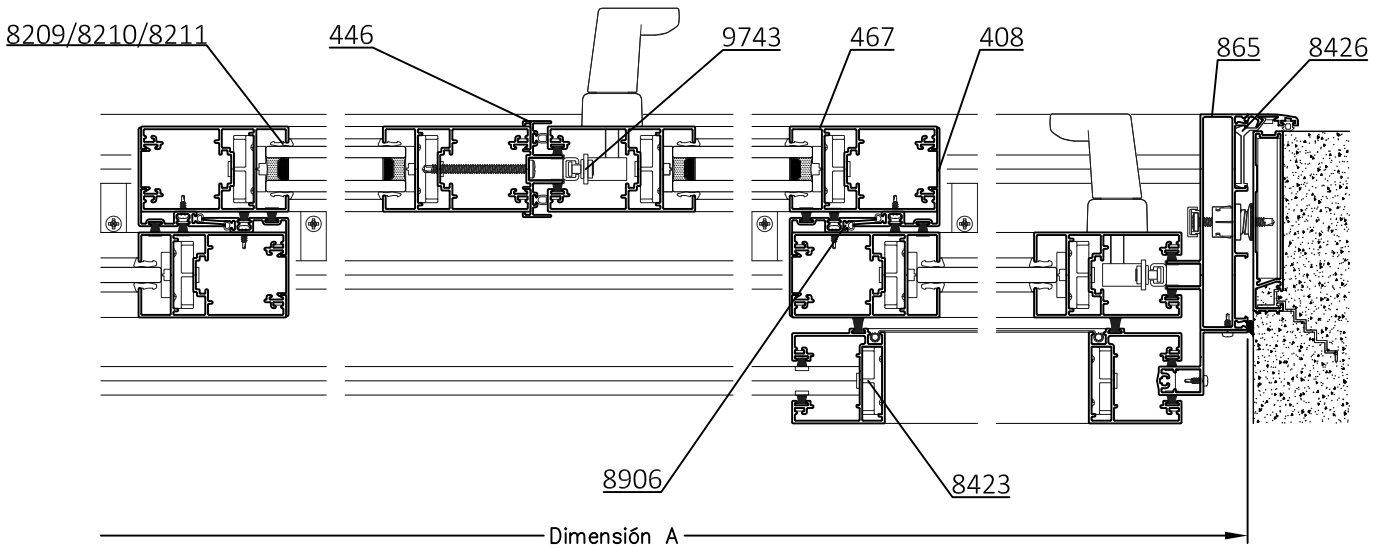
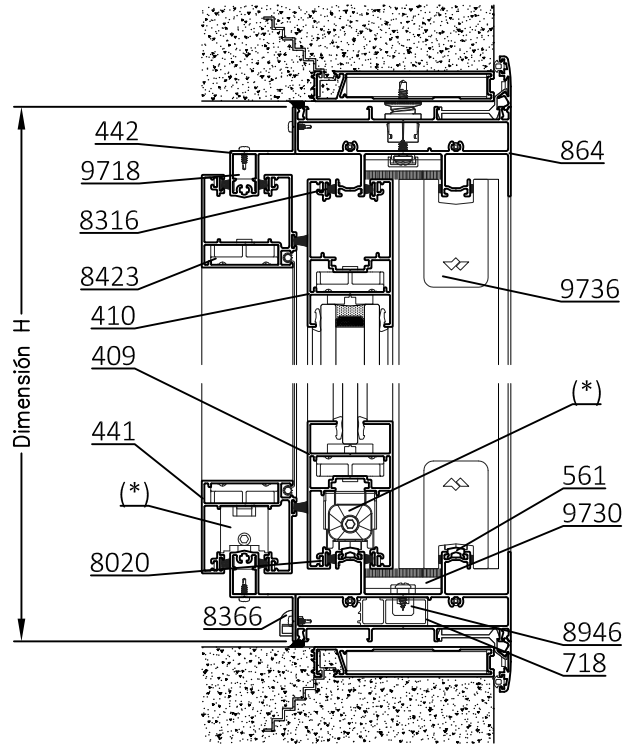

Detalle de Accesorios				
Ítem	Código	Descripción	Forma	Cantidad
Escuadra armado	8423	Escuadra armado hojas E-69		16 Unidades
	9718	Escuadra guía mosquitero	-	4 Unidades
Tornillo	8368	Tornillo Parker Parte I		12 Unidades
Cuña Vidrio	8209	Cuña Chica		4A + 12H
	8210	Cuña Mediana		
	8211	Cuña Grande		
Burlete Hermetic.	8906	Burlete AEL europeo solapa de cruce		4H
Felpa	8316	Felpa de Polipropileno 7 x 6 mm.		6A + 18H
Cierre Multipunto	9623	Mec. 2 Puntos e:7,5 mm de 400 mm p/ 4 cunas		2 Unidades
	9615	Mec. 2 Puntos e:7,5 mm de 600 mm p/ 6 cunas		
	9624	Mec. 2 Puntos e:7,5 mm de 1000 mm p/ 6 cunas		
	9616	Mec. 4 Puntos e:7,5 mm de 1200 mm p/ 8 cunas		
	9618	Cuna 18 mm mecanismo multipunto		s/m
	9599	Suplemento de cuna multipunto 6 mm		s/m
	9600	Suplemento cerradero JN multipunto		s/m
	9440	Manijas Acodadas Modelo SR Izq / Der (par)	-	1 Unidad
Rodamientos	9974	Rueda simple JN 80 Kg hoja R-46		6Unidades
	8125	Rueda simple Carrera 100 Kg hoja R-46		
	8140	Rueda simple Pabose 150 Kg hoja R-46		
	9975	Rueda doble JN 180 Kg hoja R-47		
	8126	Rueda doble Carrera 200 Kg hoja R-47		
	8141	Rueda doble Pabose 300 Kg hoja R-47		
	8932	Rueda simple Torino 40 kg hoja p/ mosqu.		
		-	2 Unidades	
Tope Central y Lat	9736	Tope Parante Central T-156		8 Unidades
	9735	Tope Parante Lateral T-165		4 Unidades
Cruce de Hoja	9730	Cruce de Hoja hoja 45° T-160		2 Unidades
	9731	Cruce de Hoja hoja 45° 3 guías T-161		2 Unidades
Boca Desagüe	8946	Boca Desagüe T-94 T-130		s/m
Tapa Desagüe	8366	Tapa Desagüe T-69 T-131		2 Unidades
Junta estanqueidad	9733	Junta de estanqu. marco corr. 3 guías T-163		2 Pares

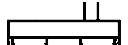
Vista



















B-B Corte Vertical



Dimensiones de Corte						
Código	Peso Kg/m	Forma	Función	Cant.	Largo	Corte
1110865	2,14		Jamba	2	H	90° 90°
1110864	2,54		Umbral Dintel	2	A-50	90° 90°
1110561	0,09		Guía Inf. Marco	2	A-50	90° 90°
1110409 (V.S) 1110467 (D.V.H) 1110410 (D.V.H)	1,34 1,29 1,26		Hoja	8	A/4+19	45° 45°
				8	H-78	45° 45°
1110408	0,46		Solapa cruce	4	H-78	90° 90°
1110446	0,49		Enc. central	1	H-78	90° 90°
1110442	0,51		Guía mosq.	2	A	45° 45°
				2	H	45° 45°
1110441	1,02		Hoja mosq.	2	A/4+19	45° 45°
				2	H-78	45° 45°

\* Medidas en milímetros  
s/m: según medida.

Corte Contramarco: pág. 3  
Corte Premarco: pág. 4

Detalle de Accesorios					
Ítem	Código	Descripción	Forma	Cantidad	
Escuadra armado	8423	Escuadra armado hojas E-69		20 Unidades	
	9718	Escuadra guía mosquitero	-	4 Unidades	
Tornillo	8368	Tornillo Parker Parte I		8 Unidades	
Cuña Vidrio	8209	Cuña Chica		4A + 16H	
	8210	Cuña Mediana			
	8211	Cuña Grande			
Burlete Hermetic. Felpa	8906	Burlete AEL europeo solapa de cruce		6H	
	8316	Felpa de Polipropileno 7 x 6 mm.		6A + 22H	
Cierre Multipunto	9623	Mec. 2 Puntos e:7,5 mm de 400 mm p/ 4 cunas		3 Unidades	
	9615	Mec. 2 Puntos e:7,5 mm de 600 mm p/ 6 cunas			
	9624	Mec. 2 Puntos e:7,5 mm de 1000 mm p/ 6 cunas			
	9616	Mec. 4 Puntos e:7,5 mm de 1200 mm p/ 8 cunas			
		9618	Cuna 18 mm mecanismo mutipunto		s/m
		9599	Suplemento de cuna multipunto 6 mm		s/m
		9600	Suplemento cerradero JN multipunto		s/m
		9452	Manija Recta SR	-	1 Unidad
	9440	Manijas Acodadas Modelo SR Izq / Der (par)	-	1 Unidad	
Rodamientos	9974	Rueda simple JN 80 Kg hoja R-46		8 Unidades	
	8125	Rueda simple Carrera 100 Kg hoja R-46			
	8140	Rueda simple Pabose 150 Kg hoja R-46			
	9975	Rueda doble JN 180 Kg hoja R-47			
	8126	Rueda doble Carrera 200 Kg hoja R-47			
	8141	Rueda doble Pabose 300 Kg hoja R-47			
	8932	Rueda simple Torino 40 kg hoja p/ mosqu.	-	2 Unidades	
Tope Central y Lat	9736	Tope Parante Central T-156		8 Unidades	
	9735	Tope Parante Lateral T-165		6 Unidades	
Cruce de Hoja	9730	Cruce de Hoja hoja 45° T-160		4 Unidades	
Boca Desagüe	8946	Boca Desagüe T-94 T-130		s/m	
Tapa Desagüe	8366	Tapa Desagüe T-69 T-131		2 Unidades	
Junta estanqueidad	9732	Junta de estanqu. marco corr. 2 guías T-162		2 Pares	

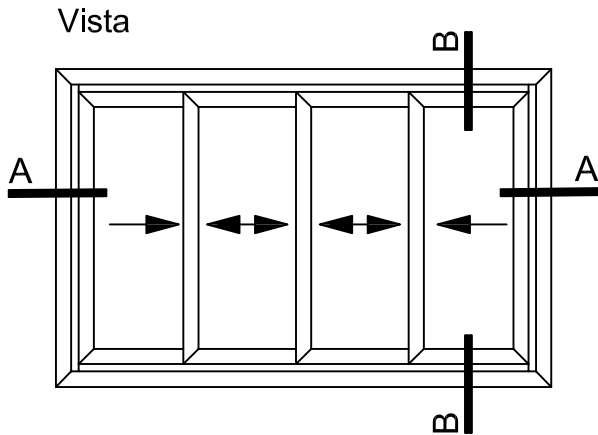

B-B Corte Vertical

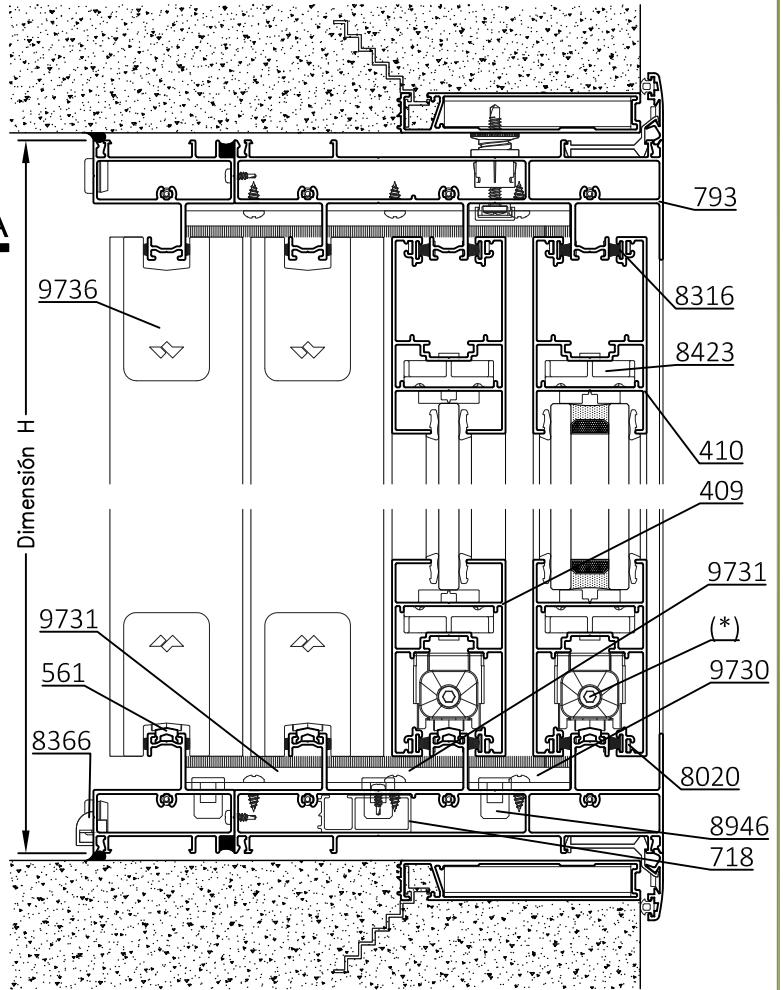

A-A Corte Horizontal

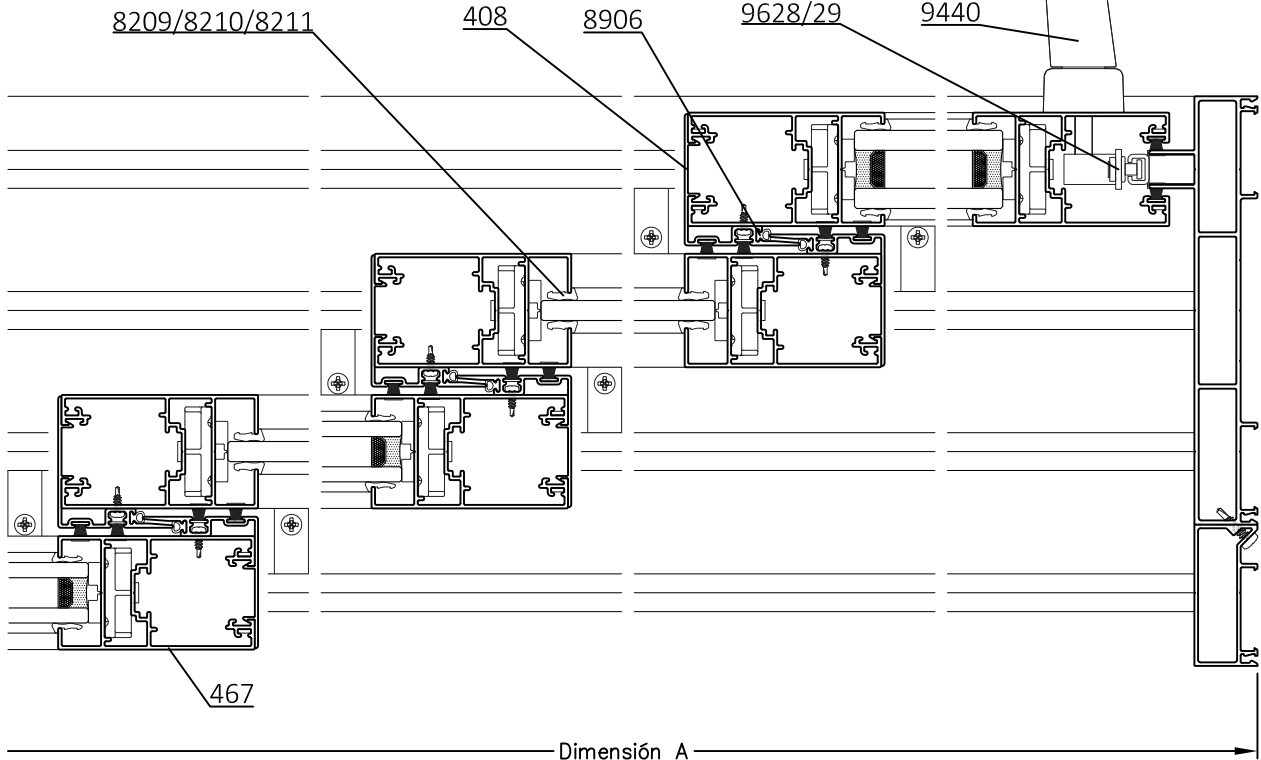





Escala 1:3

Tolerancia en Peso +/- 10%

70

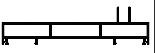
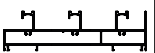

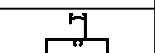

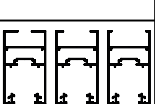
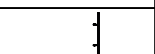











09 - 2024

NIZA

Dimensiones de Corte						
Código	Peso Kg/m	Forma	Función	Cant.	Largo	Corte
1110794	2,14		Jamba	2	H	90° 90°
1110793	2,54		Umbral Dintel	2	A-50	90° 90°
1110444	2,14		Jamba	2	H	90° 90°
1110443	2,54		Umbral Dintel	2	A-50	90° 90°
1060561	0,09		Guía Inf. Marco	4	A-50	90° 90°
1110409 (V.S) 1110467 (D.V.H) 1110410 (D.V.H)	1,34 1,29 1,26		Hoja	8 8	A/4+40 H-78	45° 45° 45° 45°
1110408	0,46		Solapa cruce	6	H-78	90° 90°

\* Medidas en milímetros  
s/m: según medida.

Corte Contramarco: pág. 3  
Corte Premarco: pág. 4

Detalle de Accesorios				
Ítem	Código	Descripción	Forma	Cantidad
Escuadra armado	8423	Escuadra armado hojas E-69		16 Unidades
	9718	Escuadra guía mosquitero	-	4 Unidades
Tornillo	8368	Tornillo Parker Parte I		16 Unidades
Cuña Vidrio	8209	Cuña Chica		4A + 16H
	8210	Cuña Mediana		
	8211	Cuña Grande		
Burlete Hermetic.	8906	Burlete AEL europeo solapa de cruce		6H
Felpa	8316	Felpa de Polipropileno 7 x 6 mm.		6A + 22H
Cierre Multipunto	9623	Mec. 2 Puntos e:7,5 mm de 400 mm p/ 4 cunas		2 Unidades
	9615	Mec. 2 Puntos e:7,5 mm de 600 mm p/ 6 cunas		
	9624	Mec. 2 Puntos e:7,5 mm de 1000 mm p/ 6 cunas		
	9616	Mec. 4 Puntos e:7,5 mm de 1200 mm p/ 8 cunas		
	9618	Cuna 18 mm mecanismo multipunto		s/m
	9599	Suplemento de cuna multipunto 6 mm		s/m
	9600	Suplemento cerradero JN multipunto		s/m
Rodamientos	9440	Manijas Acodadas Modelo SR Izq / Der (par)	-	1 Unidad
	9974	Rueda simple JN 80 Kg hoja R-46		8 Unidades
	8125	Rueda simple Carrera 100 Kg hoja R-46		
	8140	Rueda simple Pabose 150 Kg hoja R-46		
	9975	Rueda doble JN 180 Kg hoja R-47		
	8126	Rueda doble Carrera 200 Kg hoja R-47		
8141	Rueda doble Pabose 300 Kg hoja R-47			
Tope Central y Lat	9736	Tope Parante Central T-156		12 Unidades
	9735	Tope Parante Lateral T-165		4 Unidades
Cruce de Hoja	9730	Cruce de Hoja hoja 45° T-160		2 Unidades
	9731	Cruce de Hoja hoja 45° 3 guías T-161		2 Unidades
Boca Desagüe	8946	Boca Desagüe T-94 T-130		s/m
Tapa Desagüe	8366	Tapa Desagüe T-69 T-131		2 Unidades
Junta estanqueidad	9733	Junta de estanqu. marco corr. 3 guías T-163		2 Pares
	9725	Junta de estanqu. marco corr. 1 guía		2 Pares

**B-B Corte Vertical**

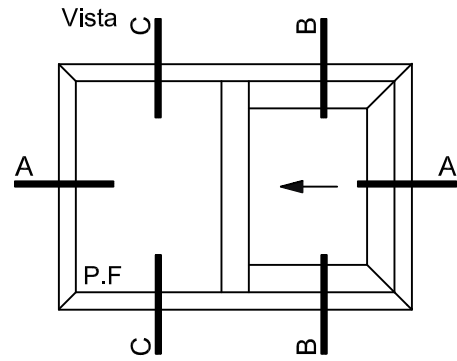
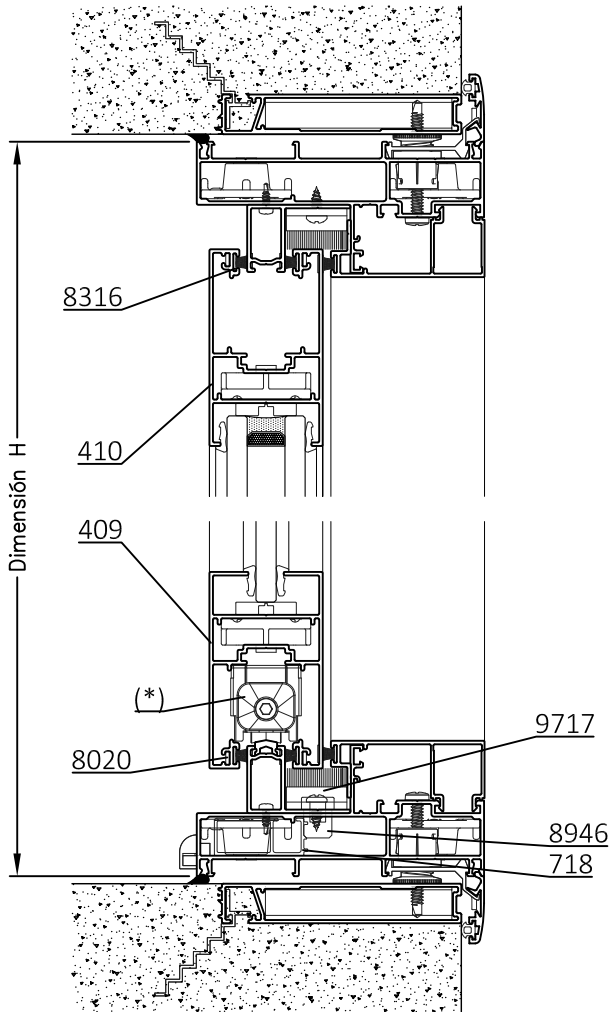



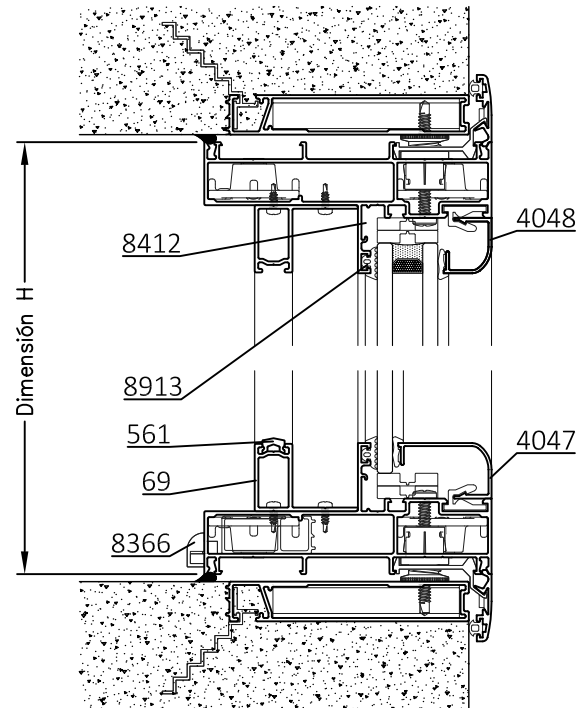

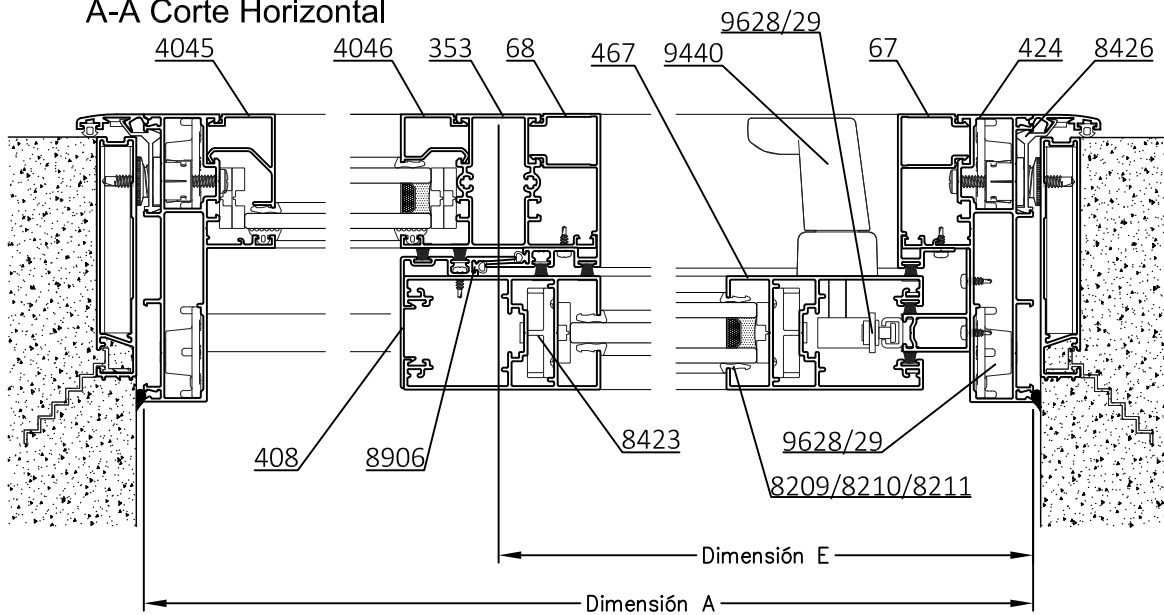

**C-C Corte Vertical**

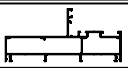

**A-A Corte Horizontal**

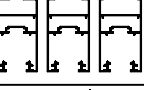





















Dimensiones de Corte						
Código	Peso Kg/m	Forma	Función	Cant.	Largo	Corte
1110424	1,49		Marco	2	A	45° 45°
				2	H	45° 45°
4047/4048/ 4050/051/052/053	-	-	Contrav. con clip	2	(A-E)-48	45° 45°
				2	H-60	45° 45°
4045/4046/ 4049	-	-	Contrav. Recto	2	(A-E)-48	90° 90°
				2	H-104	90° 90°
1110353	1,05		Parante	1	H-60	90° 90°
1060561	0,09		Guía Inf. Marco	1	A-50	90° 90°
1110409 (V.S) 1110467 (D.V.H) 1110410 (D.V.H)	1,34		Hoja	2	E-5	45° 45°
	1,29			2	H-86	45° 45°
1110408	0,46		Solapa cruce	1	H-86	90° 90°
1110067	0,55		Cierre marco	2	E-94	90° 90°
				1	H-60	90° 90°
1110068	0,71		Cierre parante	1	H-60	90° 90°
1110069	0,42		Guía fija móvil	2	A-50	90° 45°
				1	H-50	45° 45°

\* Medidas en milímetros  
s/m: según medida.

Corte Contramarco: pág. 3  
Corte Premarco: pág. 4

Detalle de Accesorios				S/Travesaño
Ítem	Código	Descripción	Forma	Cantidad
Esc. de Armado	9821 8047	Esc. de Armado Marco E-83		8 Unidades
	8423	Escuadra armado hojas E-69		4 Unidades
Clip	8916	Clip Contravidrios T-96		s/m
Burlete Vidrio	8913	Burlete de Acristalamiento B-68		2A-E + 2H
Cuña Vidrio	8209	Cuña Chica		2A-E + 2H
	8210	Cuña Mediana		4E + 4H
	8211	Cuña Grande		
Tornillo	8368	Tornillo Parker Parte I		4 Unidades
Tapón Hermetic.	9722	Tapón de Hermeticidad Caja de Agua		2 Unidades
Burlete Hermetic.	8906	Burlete AEL europeo solapa de cruce		2H
Felpa	8316	Felpa de Polipropileno 7 x 6 mm.		6E + 7H
Cierre Multipunto	9628	Mec. 4 Puntos e:15 mm de 1200 mm p/ 8 cunas		1 Unidad
	9629	Mec. 4 Puntos e:15 mm de 1600 mm p/ 8 cunas		
	9610	Mec. 4 Puntos e:15 mm de 1800 mm p/ 8 cunas		
	9619	Cuna 20 mm mecanismo multipunto		s/m
	9599	Suplemento de cuna multipunto 6 mm		s/m
Rodamientos	9440	Manijas Acodadas Modelo SR Izq ó Der	-	1 Unidad
	9974	Rueda simple JN 80 Kg hoja R-46		2 Unidades
	8125	Rueda simple Carrera 100 Kg hoja R-46		
	8140	Rueda simple Pabose 150 Kg hoja R-46		
	9975	Rueda doble JN 180 Kg hoja R-47		2 Unidades
	8126	Rueda doble Carrera 200 Kg hoja R-47		
8141	Rueda doble Pabose 300 Kg hoja R-47			
Tope Central y Lat	9736	Tope Parante Central T-156		2 Unidades
	9735	Tope Parante Lateral T-165		2 Unidades
Cruce de Hoja	9717	Cruce de Hoja Fija Móvil		2 Unidades
Boca Desagüe	8946	Boca Desagüe T-94 T-130		s/m
Tapa Desagüe	8366	Tapa Desagüe T-69 T-131		2 Unidades

B-B Corte Vertical

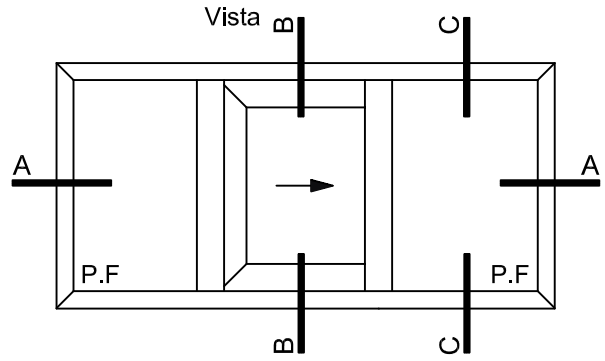
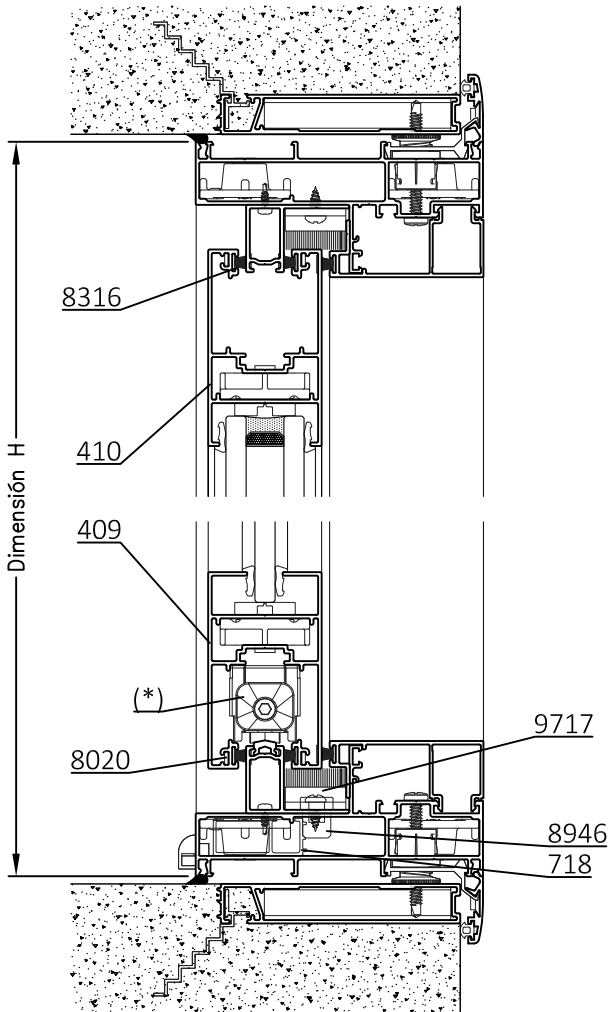



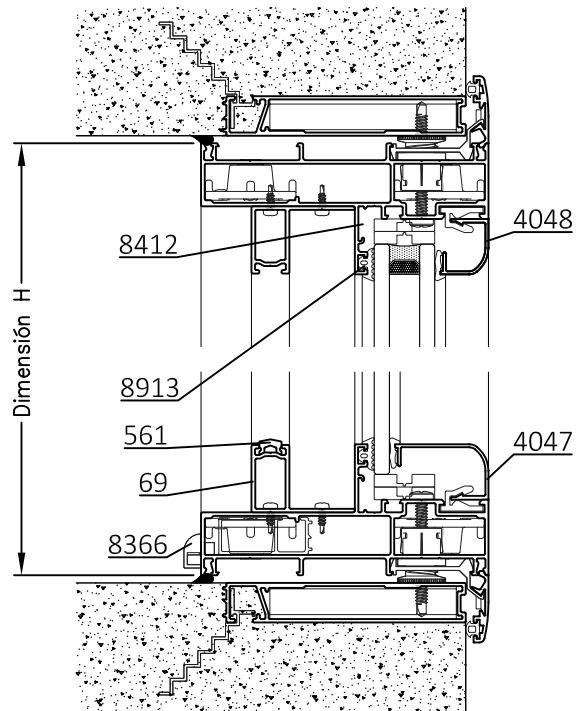



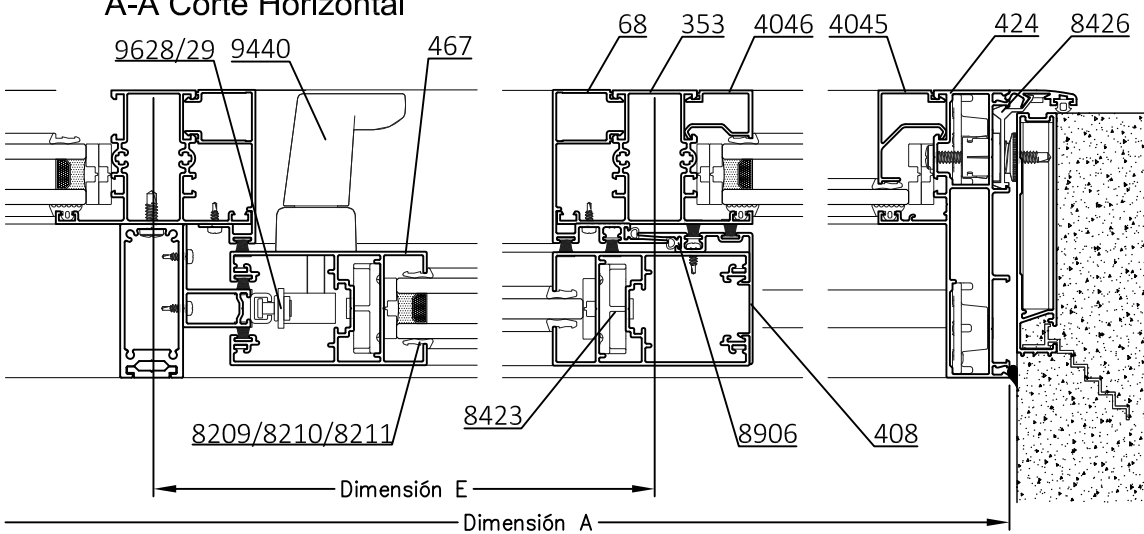

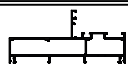
C-C Corte Vertical

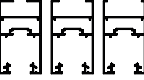

A-A Corte Horizontal



Dimensiones de Corte						
Código	Peso Kg/m	Forma	Función	Cant.	Largo	Corte
1110424	1,49		Marco	2	A	45° 45°
				2	H	45° 45°
4047/4048/ 4050/051/052/053	-	-	Contrav. con clip	4	(A-E-48)/2	45° 45°
				4	H-60	45° 45°
4045/4046/ 4049	-	-	Contrav. Recto	4	(A-E-48)/2	90° 90°
				4	H-104	90° 90°
1110353	1,05		Parante	2	H-60	90° 90°
1060561	0,09		Guía Inf.	1	(A+E)/2-35	90° 90°
1110409 (V.S) 1110467 (D.V.H) 1110410 (D.V.H)	1,34		Hoja	2	E+9	45° 45°
	1,29			2	H-86	45° 45°
	1,26					
1110408	0,46		Solapa cruce	1	H-86	90° 90°
1110067	0,55		Cierre marco	2	E-81	90° 90°
				1	H-60	90° 90°
1110068	0,71		Cierre parante	1	H-60	90° 90°
1110069	0,42		Guía fija móvil	2	(A+E)/2-11	90° 45°
				1	H-50	45° 45°
1110998	1,08		Refuerzo inercial	1	H-50	90° 90°
1020703	0,15		Pletina	1	H-50	90° 90°

Detalle de Accesorios				S/Travesaño		
Ítem	Código	Descripción	Forma			
Esc. de Armado	9821 8047	Esc. de Armado Marco E-83				
	8423	Escuadra armado hojas E-69				
Clip	8916	Clip Contravidrios T-96	-			
Burlete Vidrio	8913	Burlete de Acristalamiento B-68	-			
Cuña Vidrio	8209	Cuña Chica		4E + 4H		
	8210	Cuña Mediana				
	8211	Cuña Grande				
Tornillo	8368	Tornillo Parker Parte I		8 Unidades		
Tapón Hermetic.	9722	Tapón de Hermeticidad Caja de Agua		2 Unidades		
Burlete Hermetic.	8906	Burlete AEL europeo solapa de cruce		2H		
Felpa	8316	Felpa de Polipropileno 7 x 6 mm.		6E + 7H		
Cierre Multipunto	9628	Mec. 4 Puntos e:15 mm de 1200 mm p/ 8 cunas		1 Unidad		
	9629	Mec. 4 Puntos e:15 mm de 1600 mm p/ 8 cunas				
	9610	Mec. 4 Puntos e:15 mm de 1800 mm p/ 8 cunas				
	9619	Cuna 20 mm mecanismo multipunto				s/m
	9599	Suplemento de cuna multipunto 6 mm				s/m
Rodamientos	9440	Manijas Acodadas Modelo SR Izq / Der (par)	-	1 Unidad		
	9974	Rueda simple JN 80 Kg hoja R-46		2 Unidades		
	8125	Rueda simple Carrera 100 Kg hoja R-46				
	8140	Rueda simple Pabose 150 Kg hoja R-46				
	9975	Rueda doble JN 180 Kg hoja R-47				
	8126	Rueda doble Carrera 200 Kg hoja R-47				
8141	Rueda doble Pabose 300 Kg hoja R-47					
Tope Central y Lat	9736	Tope Parante Central T-156		2 Unidades		
	9735	Tope Parante Lateral T-165		2 Unidades		
Cruce de Hoja	9717	Cruce de Hoja Fija Móvil	-	2 Unidades		
Boca Desagüe	8946	Boca Desagüe T-94 T-130		s/m		
Tapa Desagüe	8946	Tapa Desagüe T-69 T-131		2 Unidades		

C-C Corte Vertical

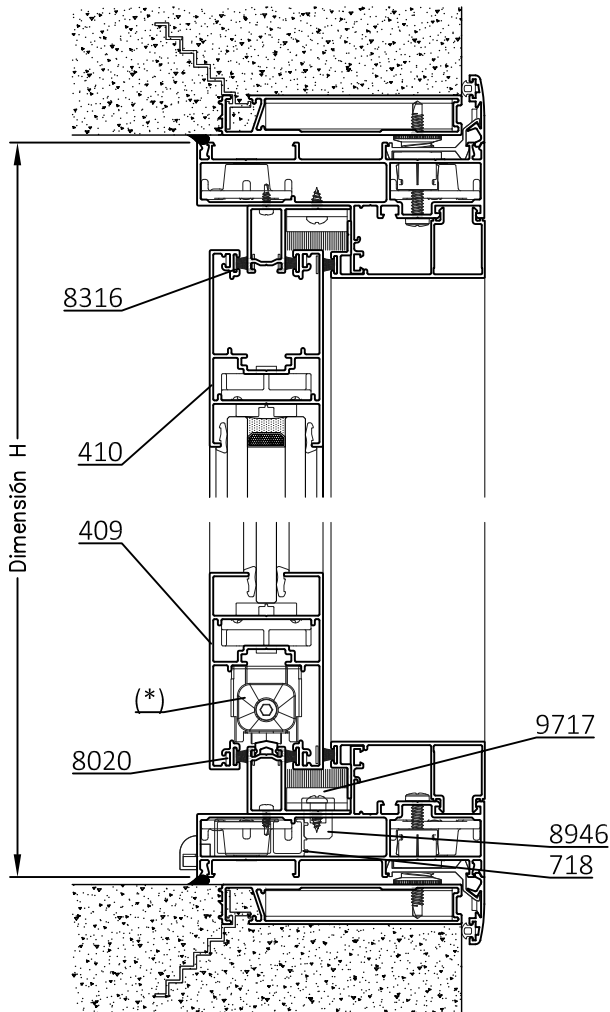

Vista

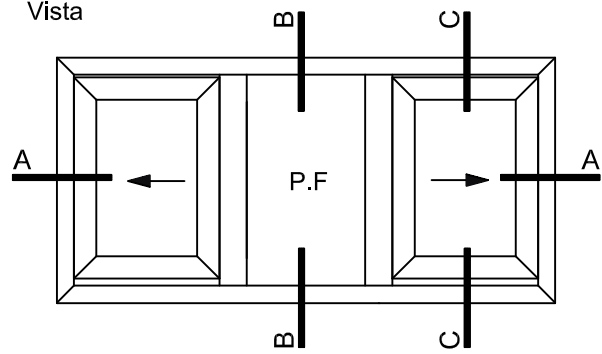



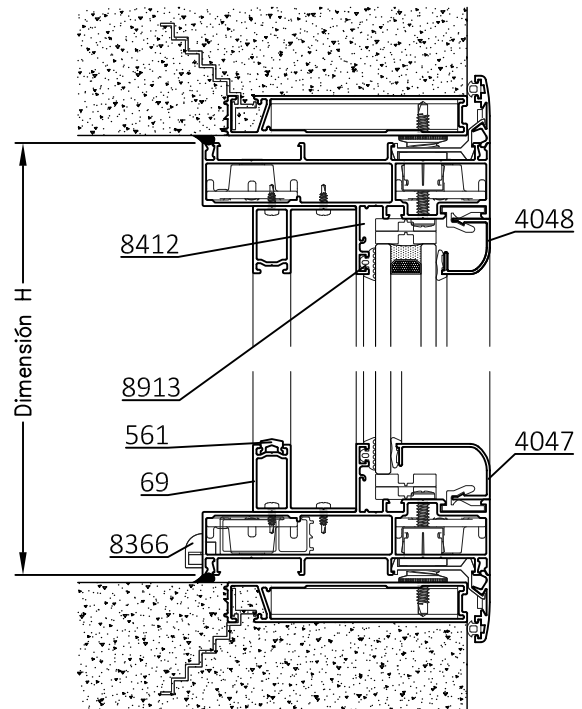

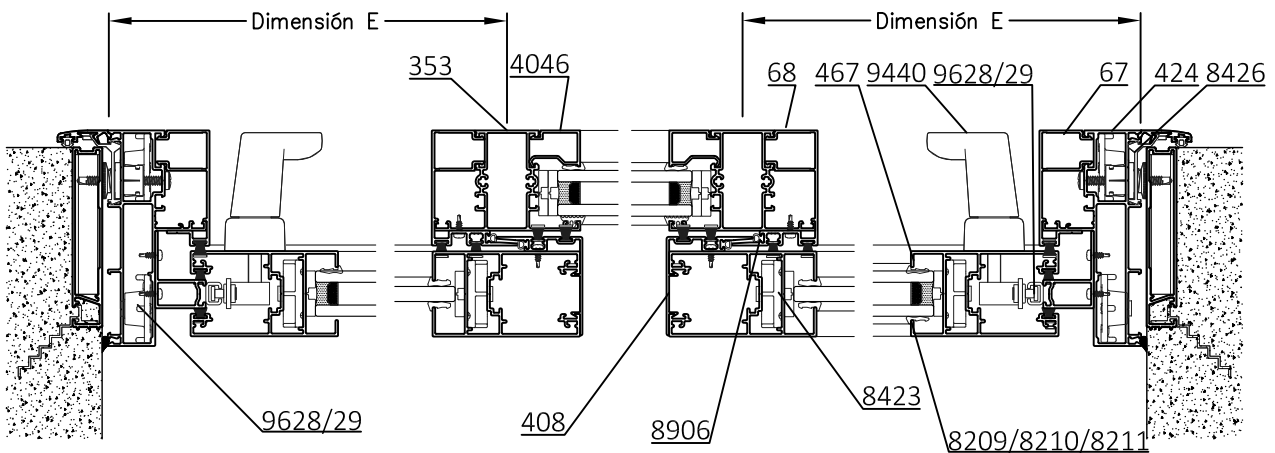

B-B Corte Vertical

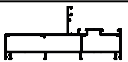

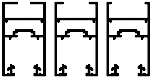

















A-A Corte Horizontal



Dimensiones de Corte						
Código	Peso Kg/m	Forma	Función	Cant.	Largo	Corte
1110424	1,49		Marco	2	A	45° 45°
				2	H	45° 45°
44047/4048/ 4050/051/052/053	-	-	Contrav. con clip	2	(A-2E)-33	45° 45°
				2	H-60	45° 45°
4045/4046/ 4049	-	-	Contrav. Recto	2	(A-2E)-77	90° 90°
				2	H-60	90° 90°
1110353	1,05		Parante	1	H-60	90° 90°
1060561	0,09		Guía Inf. Marco	1	A-104	90° 90°
1110409 (V.S) 1110467 (D.V.H) 1110410 (D.V.H)	1,34		Hoja	4	E-6	45° 45°
	1,29			4	H-86	45° 45°
	1,26					
1110408	0,46		Solapa cruce	2	H-86	90° 90°
1110067	0,55		Cierre marco	4	E-94	90° 90°
				2	H-60	90° 90°
1110068	0,71		Cierre parante	2	H-60	90° 90°
1110069	0,42		Guía fija móvil	2	A-50	90° 45°
				2	H-50	45° 45°

\* Medidas en milímetros  
s/m: según medida.

Corte Contramarco: pág. 3  
Corte Premarco: pág. 4

Detalle de Accesorios				S/Travesaño
Ítem	Código	Descripción	Forma	Cantidad
Esc. de Armado	9821 8047	Esc. de Armado Marco E-83		8 Unidades
	8423	Escuadra armado hojas E-69		8 Unidades
Clip	8916	Clip Contravidrios T-96		s/m
Burlete Vidrio	8913	Burlete de Acristalamiento B-68		2A-E + 2H
Cuña Vidrio	8209	Cuña Chica		4A-E + 4H
	8210	Cuña Mediana		4E + 4H
	8211	Cuña Grande		
Tornillo	8368	Tornillo Parker Parte I		8 Unidades
Tapón Hermetic.	9722	Tapón de Hermeticidad Caja de Agua		2 Unidades
Burlete Hermetic.	8906	Burlete AEL europeo solapa de cruce		4H
Felpa	8316	Felpa de Polipropileno 7 x 6 mm.		12E + 14H
Cierre Multipunto	9628	Mec. 4 Puntos e:15 mm de 1200 mm p/ 8 cunas		2 Unidades
	9629	Mec. 4 Puntos e:15 mm de 1600 mm p/ 8 cunas		
	9610	Mec. 4 Puntos e:15 mm de 1800 mm p/ 8 cunas		
	9619	Cuna 20 mm mecanismo mutipunto		s/m
	9599	Suplemento de cuna multipunto 6 mm		s/m
	9440	Manijas Acodadas Modelo SR Izq ó Der	-	1 Unidad
Rodamientos	9974	Rueda simple JN 80 Kg hoja R-46		4 Unidades
	8125	Rueda simple Carrera 100 Kg hoja R-46		
	8140	Rueda simple Pabose 150 Kg hoja R-46		
	9975	Rueda doble JN 180 Kg hoja R-47		
	8126	Rueda doble Carrera 200 Kg hoja R-47		
	8141	Rueda doble Pabose 300 Kg hoja R-47		
Tope Central y Lat	9736	Tope Parante Central T-156		4 Unidades
	9735	Tope Parante Lateral T-165		4 Unidades
Cruce de Hoja	9717	Cruce de Hoja Fija Móvil		4 Unidades
Boca Desagüe	8946	Boca Desagüe T-94 T-130		s/m
Tapa Desagüe	8366	Tapa Desagüe T-69 T-131		2 Unidades

B-B Corte Vertical

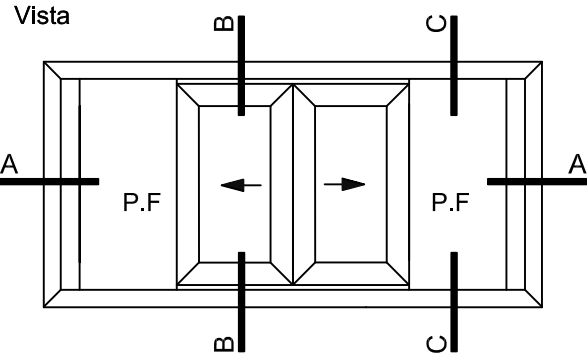
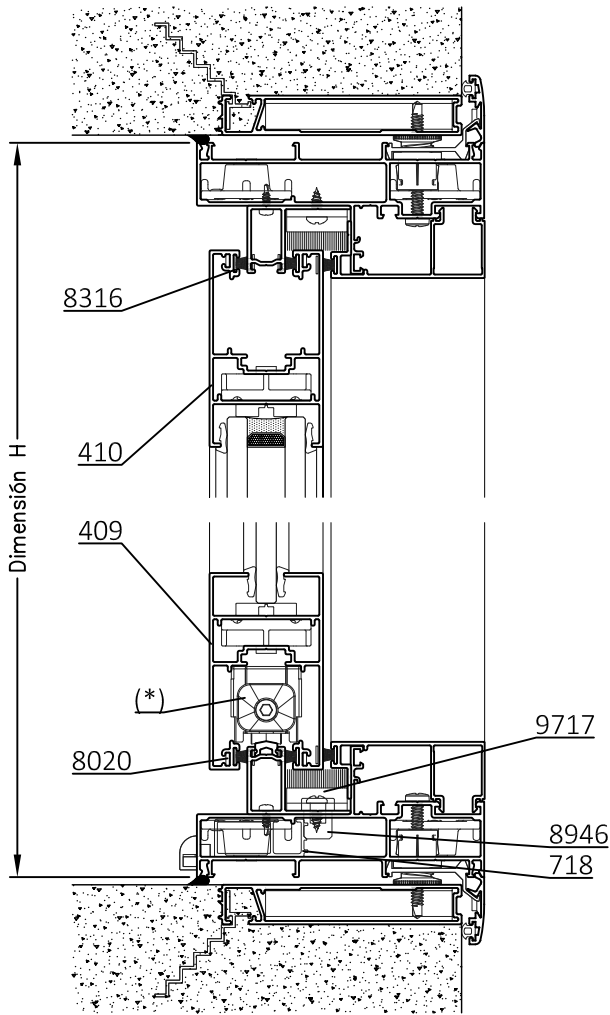



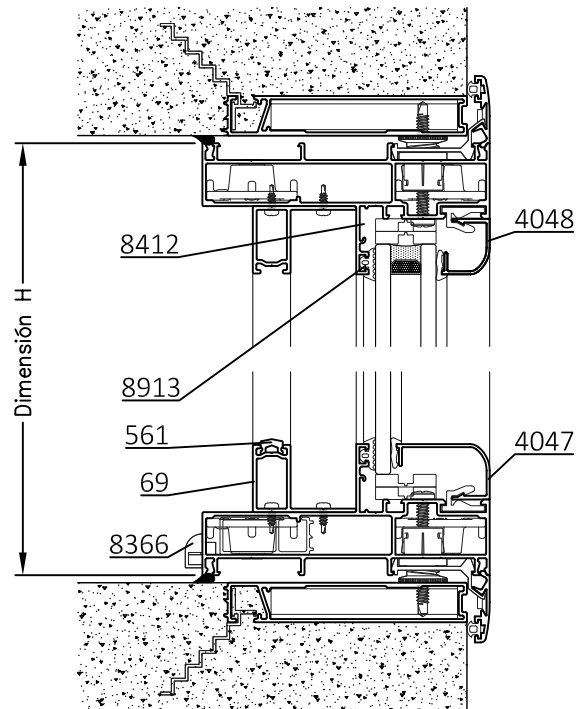



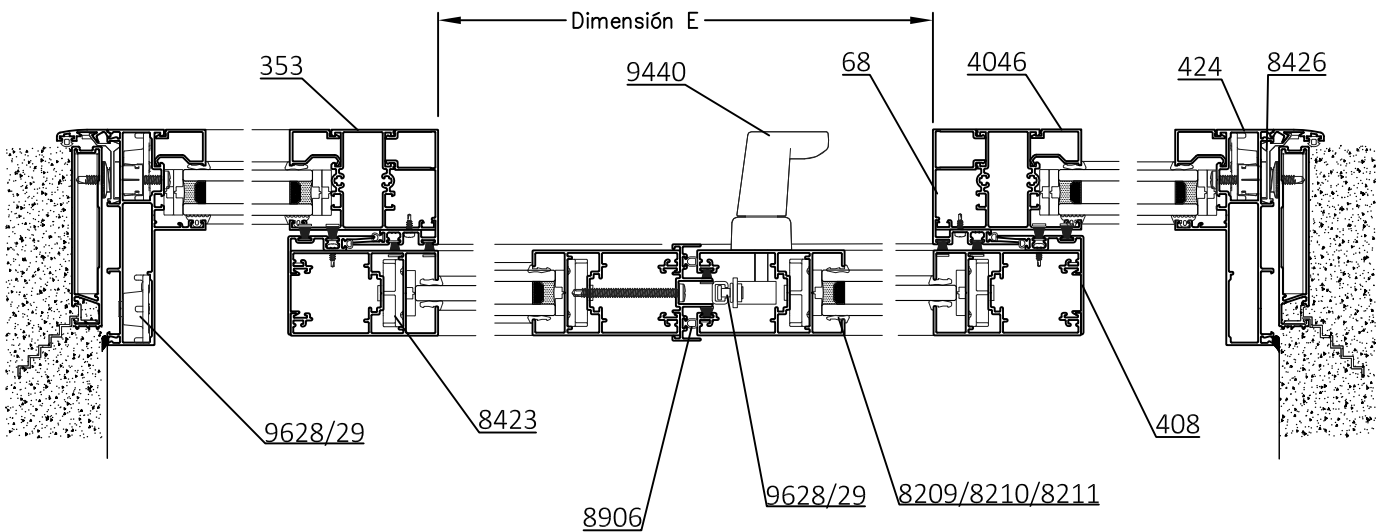

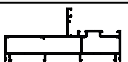
C-C Corte Vertical

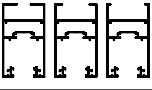















A-A Corte Horizontal

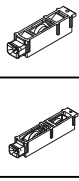

Dimensiones de Corte						
Código	Peso kg/m	Forma	Función	Cant.	Largo	Corte
1110424	1,49		Marco	2	A	45° 45°
				2	H	45° 45°
4047/4048/ 4050/051/052/053	-	-	Contrav. con clip	4	[(A-E)/2]-87	45° 45°
				4	H-60	45° 45°
4045/4046/ 4049	-	-	Contrav. Recto	2	[(A-E)/2]-131	90° 90°
				2	H-60	90° 90°
1110353	1,05		Parante	1	H-60	90° 90°
1060561	0,09		Guía Inf. Marco	1	A-60	90° 90°
1110409 (V.S) 1110467 (D.V.H) 1110410 (D.V.H)	1,34		Hoja	4	(E/2)+74	45° 45°
	1,29			4	H-86	45° 45°
1110410 (D.V.H)	1,26					
1110408	0,46		Solapa cruce	2	H-86	90° 90°
1110067	0,55		Cierre marco	2	E	90° 90°
1110068	0,71		Cierre parante	2	H-60	90° 90°
1110069	0,42		Guía fija móvil	2	A-60	90° 90°
1110446	0,49		Enc. central	1	H-86	90° 90°

\* Medidas en milímetros  
s/m: según medida.

Corte Contramarco: pág. 3  
Corte Premarco: pág. 4

Detalle de Accesorios				S/Travesaño	
Ítem	Código	Descripción	Forma	Cantidad	
Esc. de Armado	9821 8047	Esc. de Armado Marco E-83		8 Unidades	
	8423	Escuadra armado hojas E-69		8 Unidades	
Clip	8916	Clip Contravidrios T-96		s/m	
Burlete Vidrio	8913	Burlete de Acristalamiento B-68		4A-E + 4H	
Cuña Vidrio	8209	Cuña Chica		4A-E + 4H	
	8210	Cuña Mediana			
	8211	Cuña Grande			
Tornillo	8368	Tornillo Parker Parte I		4 Unidades	
Tapón Hermetic.	9722	Tapón de Hermeticidad Caja de Agua		2 Unidades	
Burlete Hermetic.	8906	Burlete AEL europeo solapa de cruce		2H	
Felpa	8316	Felpa de Polipropileno 7 x 6 mm.		6E + 7H	
Cierre Multipunto	9628	Mec. 4 Puntos e:15 mm de 1200 mm p/ 8 cunas		1 Unidad	
	9629	Mec. 4 Puntos e:15 mm de 1600 mm p/ 8 cunas			
	9610	Mec. 4 Puntos e:15 mm de 1800 mm p/ 8 cunas			
	9619	Cuna 20 mm mecanismo mutipunto			s/m
	9599	Suplemento de cuna multipunto 6 mm			s/m
	9440	Manijas Acodadas Modelo SR Izq ó Der	-	1 Unidad	
Rodamientos	9974	Rueda simple JN 80 Kg hoja R-46		4 Unidades	
	8125	Rueda simple Carrera 100 Kg hoja R-46			
	8140	Rueda simple Pabose 150 Kg hoja R-46			
	9975	Rueda doble JN 180 Kg hoja R-47			
	8126	Rueda doble Carrera 200 Kg hoja R-47			
	8141	Rueda doble Pabose 300 Kg hoja R-47			
Tope Central y Lat	9736	Tope Parante Central T-156		4 Unidades	
	9735	Tope Parante Lateral T-165		4 Unidades	
Cruce de Hoja	9717	Cruce de Hoja Fija Móvil		2 Unidades	
Boca Desagüe	8946	Boca Desagüe T-94 T-130		s/m	
Tapa Desagüe	8366	Tapa Desagüe T-69 T-131		2 Unidades	

